

---

## Section 2: Final Design Criteria

---

Yuba-Sutter Transit Resilient Next Generation Transit Facility Plan

Marysville, California



Prepared by: WSP

February 2021



FUNDED BY:



The Yuba-Sutter Transit Resilient Next Generation Transit Facility Study was funded by the California Department of Transportation (Caltrans) through the Sustainable Transportation Planning Grant Program.

# TABLE OF CONTENTS

GENERAL CONSIDERATIONS .....	2
PROJECT GOALS.....	5
SPACE NEEDS PROGRAM .....	11
FUNCTIONAL RELATIONSHIP DIAGRAMS AND FUNCTIONAL AREA MODULES .....	20
ELECTRICAL SERVICE APPROACH .....	151
SITE AND BUILDING REQUIREMENTS.....	161
APPENDIX A SIGN IN SHEET .....	182
APPENDIX B PROGRAMMING QUESTIONNAIRES.....	185
APPENDIX C CONSIDERED OPTIONS AND SITE TEST FITS .....	201
APPENDIX D GREENFIELD SITES AND BUILDING LAYOUTS .....	228

# GENERAL CONSIDERATIONS

---

## ACKNOWLEDGMENTS

The design team would like to thank the following Yuba-Sutter staff members that participated in the interviews for their time and input which made possible the development of the data contained herein.

### Yuba-Sutter Transit

Keith Martin ..... Transit Manager  
Adam Hansen ..... Planning Program Manager  
Simone Reed ..... Finance Program Manager  
Amy White..... Program Analyst

### Storer Transportation

Renick House ..... General Manager  
Steven Fernandes..... Vice President  
Bill Harris ..... Assistant Operations Manager  
Bill Hummer ..... Maintenance Director  
Bruce Cannon ..... Maintenance Director

### Design Team

Alva Carrasco.....Project Manager  
Jewels Carter .....Zero-Emissions Transit Facility Specialist  
Kristina Svensk ..... Site Analysis  
Tim Grose .....Environmental and Climate Vulnerability  
Rafael Ruiz.....Functional Design Specialist

## BACKGROUND

Yuba-Sutter Transit purchased and renovated its existing 3.2 acre site and former 7-Up bottling plant in 1996 for use as a transit operations, maintenance, and administration facility. It was expanded and remodeled again in 2011 to its current and ultimate capacity. The facility has served the growing transit system well over the years, but the recent adoption of the Innovative Clean Transit regulations by the California Air Resources Board requires that 25 percent of buses purchased after 2025 and 100 percent of buses purchased after 2028 be zero emission buses (ZEBs) has created a need for additional space for ZEB fueling infrastructure. Additionally, a potential Highway 70 widening project will also impact the existing Yuba Sutter Transit facility by reducing the northern bus parking area. To address these fleet capacity and operational impacts, a new site will be selected for a new Yuba-Sutter Transit Operations and Maintenance Facility. The proposed project is to include the following facilities:

- Administration and Operations Facility
- Maintenance Facility
- Fuel and Wash Facilities
- Agency Vehicle Parking / Battery Electric Bus Charging Infrastructure
- Employee / Visitor parking

## INTRODUCTION

This document contains the criteria for design of the Yuba-Sutter Transit facility and defines the necessary spaces and requirements for operational efficiencies, providing the foundation for preliminary design. The information gathered in the design criteria is organized in the following chapters:

- **Chapter 1: General Considerations.** Lists pertinent information that influences design.
- **Chapter 2: Space Needs Program.** Delineates the space requirements for offices, maintenance bays & shops, support spaces, parts storage, vehicle/equipment storage, diesel fuel and Battery Electric Bus Charging infrastructure, and wash facilities.
- **Chapter 3: Functional Requirements.** Presents the functional requirements for offices, maintenance bays & shops, support spaces, parts storage, vehicle/equipment storage, diesel fuel and Battery Electric Bus Charging infrastructure, and wash facilities.
- **Chapter 4: Site & Building Requirements.** General design criteria relating to architecture, structure, mechanical, electrical, civil, and landscaping, as well as security, signage/graphics, and waste handling issues.
- **Appendices:** Additional data to support this design Criteria including existing as well as future data including:
  - ~ Sign-in sheets from programming and concept workshops, which lists the individuals interviewed in various meetings and conceptual layouts
  - ~ Programming Questionnaires – copies of the WSP developed questionnaire and the various Yuba Sutter Transit responses as received.
  - ~ Considered Site Options and Layouts – copies of the conceptual facility and site plans developed over the course of this project.



## METHODOLOGY

The first step in developing the design for Yuba-Sutter Transit Resilient Next Generation Transit Facility Plan is to gain a thorough understanding of the operational characteristics and functional needs of each department to be located on the new site. Methods used to gain this knowledge included personal interviews with Yuba-Sutter Transit employees that may be affected by this project, on-site observations, and review of existing documents relative to this project. The flow chart below illustrates the project approach being used to develop the Yuba-Sutter Transit Resilient Next Generation Transit Facility Plan.

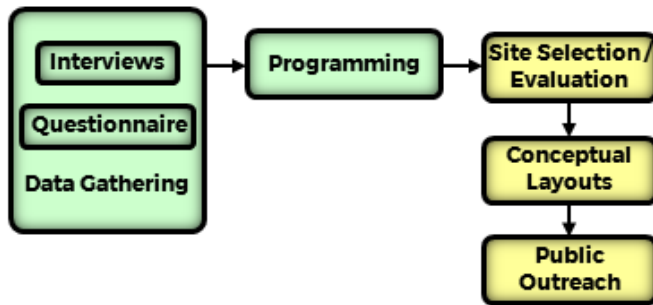

- Interviews:** In-depth interviews were conducted to gain full knowledge of the inner workings of the system. During this interview stage the design team works closely with Yuba-Sutter Transit staff to objectively define maintenance techniques, policies, procedures, and equipment requirements.
- On-site Observations:** On-site observations are a direct way to understand current operations which allows for early diagnosis of problems / opportunities and, coupled with the interviews, provides a well- rounded sense of what is needed for the overall success of the project.
- Programming:** The Programming document provides Preliminary Space Needs Program and Functional Requirements data that defines the areas (sq. ft.) involved with

specific functions as well as provides graphical representations on how those spaces can be organized. Based on the programming, a preliminary construction cost estimate is developed.

**Site Selection:** Based on the requirements set forth herein, specific site selection criteria must be developed. Sites shall be evaluated not just as a piece of property but as a functional space serving its intended maintenance and operational needs. Potential sites must be identified and evaluated, along with conducting any required environmental analysis. Once a preferred site is selected, the site must be acquired, following all applicable federal, state, and local requirements.

**Conceptual Design:** In the conceptual design phase, alternatives will be developed for the site configurations and general building design including development and layout of the zero emission and/or charging equipment and infrastructure for battery electric bus and hydrogen fueling.

**Public Outreach:** An outreach plan will be developed which will provide a structure that allows for scheduling, documentation, and evaluation of each step of the public involvement process and engagement efforts. The purpose of the outreach plan is to offer a systematic and strategic approach for reaching diverse groups of people and interests in the geographic areas, including disadvantaged communities.

## PROJECT GOALS

---

The following project goals were developed with Yuba-Sutter Transit staff during programming interviews and from returned programming questionnaires. The project goals are listed in no particular order or priority.

1. The facility should be designed with resiliency in mind.
2. Provide back-up operations for designated facility functions and ZEB support during emergencies.
3. Sustainable facility design based on surrounding climate conditions.
4. Location of new facility should be considered based on dead head to minimize operating costs.
5. New facility should be designed with planned growth in mind and shall be flexible.
6. Design should provide ease of access to the public for transit related needs such as ID photo cards and application for services.
7. Charging infrastructure for Battery Electric Bus (BEB) shall be designed into the site and facility.
8. Site and facility design shall be such to consider hydrogen fuel cell technology to support hydrogen fuel cell electric vehicles (FCEV).
9. Design of facility shall provide for upgraded work conditions compared to current facility.
10. Enhanced office spaces shall be considered for the new design.
11. Consideration shall be taken for facility environmental impacts.
12. Secure and adequate private parking for employees.
13. Safe site and facility circulation for staff and vehicles.
14. Integration of driver and bus change out at facility.
15. Access control for entering site for visitors and deliveries with automatic gates.
16. Secure site against homeless wandering onto property.
17. Design for adequate natural lighting into facility.

## DAILY ACTIVITIES

This section is intended to provide a basic understanding of the day-to-day operations and maintenance activities that will take place at the new facility.

### Operations

Operators responsible for driving the morning service arrive in the early morning hours and park their private vehicles in the designated parking area. They report and receive their assignments and instruction from the Dispatcher. They proceed to the bus parking area and perform a pre-trip inspection of the vehicle prior to leaving on their route. If the existing fleet is converted to an all BEB fleet the bus is disconnected from in-parking space chargers or if the fleet is converted to FCEV the bus is driven out of bus parking. When Operators return to the site in the evening at the end of daily bus service, they will stop at the Fuel and Vault Pull Lanes to queue buses for Service personnel. Operators then return to Operations to file necessary reports with the Dispatcher. Service personnel will pull the fares every Tuesday and Thursday to be taken to the Coin Room for counting. The Service personnel will then run the buses through Fuel and Wash and return the bus to the designated parking space. Diesel fueling of buses will continue for the foreseeable future until the entire fleet is converted to an FCEV fleet in which hydrogen fueling will take place. If the fleet is converted to a BEB fleet, the BEBs will still follow the above site flow description including being queued with diesel buses for vault pull, tire pressure checking and interior cleaning. After leaving Fuel the buses will be moved through the Wash bay and to bus parking to be either parked (diesel / FCEV) or parked and the (BEB) bus will be connected to an in-place charger for charging overnight. The Fuel lanes will also serve as the Detail Lanes for cleaning of buses when the lanes are not being used for fueling vehicles.

An alternative to queued parking upon inbound buses, no matter the fuel / propulsion type, are parked in their specific assigned parking spaces. Operators then fuel (diesel / FCEV) their assigned vehicles as needed prior to leaving the site in the morning or during mid-day returns back at the bus yard. Note this operation description is predicated on having site space for dedicated assigned bus parking with access to every bus.

Beginning and ending of shifts generate considerable transit vehicle and automobile traffic on and around the site. Moving vehicles for maintenance, inspection, fuel & wash, and other related repairs generates additional on-site traffic. The greatest amount of intra-site traffic will occur in the evening hours between 6:00 p.m. and 10:00 p.m. During this time, service personnel will drive vehicles through the Fuel Island, Bus Wash, and into Maintenance for repairs or inspections, or to the designated parking area. Separation of bus and personnel traffic is desirable for safety.

### MAINTENANCE

Maintenance personnel will work on one shift performing varied tasks 6 days per week. The facility will house general maintenance, inspection, tire, brake, parts distribution, and other daily maintenance functions. During all shifts all maintenance activities will be performed. During the evening shift, personnel assigned to Fuel and Wash sweep out the interiors of vehicles, replenish engine oil and coolant levels, fill the fuel tanks, and perform a visual inspection of the vehicle exterior noting defects that require immediate attention. After sweeping out the interior, fueling, and topping off lubricants, the service worker drives the vehicle through the vehicle washer. If the vehicle requires repair or is scheduled for inspection, it will be parked in a designated Down Line parking area. If no work is required, the vehicle will be returned to the regular parking area, Ready Line, and the service worker begins the process again with the next vehicle. Note that the facility design should provide flexibility to allow all maintenance activities to be performed on all shifts.

Vehicles awaiting repair will be cycled through maintenance bays based on work orders generated from defect reports, road calls, accidents, and warranty problems. Items found during scheduled preventative maintenance repairs (PM's) are addressed before the bus is returned to service. By preference, the majority of repairs should be performed on a scheduled basis, but there will always be a certain level of on-going repair work required by failures and incidents.

Inspections are performed on a scheduled basis established by mileage intervals and seasonal requirements. A vehicle has its engine cleaned in the Chassis Wash prior to inspection or other service, allowing sufficient time for leaks to become apparent. Should a vehicle need additional repair based upon inspection findings, it will remain in the bay until the repairs are made.

## ON-SITE TRAFFIC MOVEMENT

The mixing of moving vehicles and employees on the site must be carefully considered and incorporated into the overall traffic pattern. Pedestrian walkways must be safely and efficiently located and readily identifiable to promote effective management and the enforcement of safety standards. This section identifies many of the areas where vehicles and pedestrians mingle. Transit vehicles, delivery trucks, service vehicles, forklifts, and the privately owned vehicles of staff personnel are assigned to parking or staging areas around the site. An explanation of how vehicles will be parked and staged follows.

### AGENCY VEHICLE TRAFFIC

Transit vehicles enter the site and are staged for Fuel and Wash activities. Vehicles move from Fuel and Wash to Repair, Inspection, and other maintenance areas, or are moved to the bus parking area as shown on the following graphic. Careful consideration should be given to reduce backing movements wherever possible. If backing movements are required, they should be limited to times when the vehicle is being driven by Service personnel.

Note that Exhibit 1.2 below illustrates the overall flow of vehicles and pedestrian traffic flows on and off site that should be accommodated at the new facility.

### EXHIBIT 1.2: TRANSIT VEHICLE TRAFFIC FLOW

1.

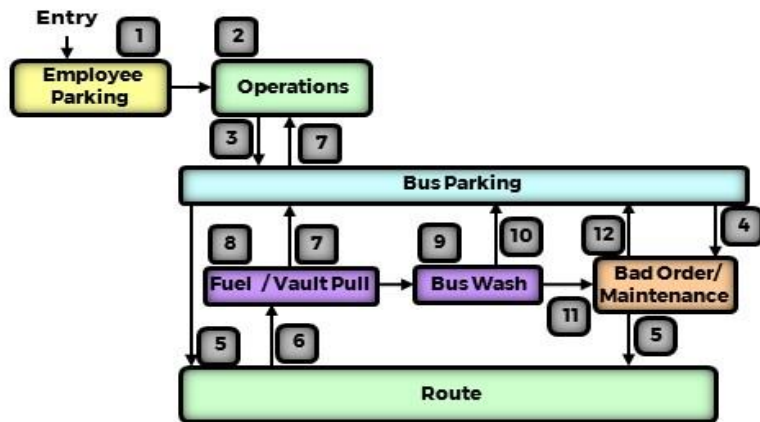

- Operator arrives on site and parks in employee parking area.
2. Operator picks up route information at Dispatch.
3. Operator gets bus assignment from the Dispatcher and proceeds to the Bus Parking area. Operator performs a pre-trip inspection in the Agency Vehicle Parking area to check lights, brakes, tires, and cleanliness. BEB vehicles are disconnected from their charging system. The wheelchair life and bike rack are cycled in the bus parking spot.
4. If a problem is found with the bus, it is taken to maintenance for immediate repairs.
5. After immediate repairs or if no pre-check issues are found, the bus leaves the site and goes on route.
6. At the end of the daily run and upon entering the site the buses queue at Fuel and Vault Pull where the fares are collected every Tuesday and Thursday.
7. Operator reports to the Dispatcher and typically leaves the site.
8. Service worker fuels the vehicle and tops off fluids. Bus interior is also cleaned in this area.
9. Bus is taken through the Wash area for exterior cleaning.
10. If no problems are reported, the bus is moved to Ready Line area in Bus Parking.
11. If a problem is reported or service is scheduled; the bus is parked in a designated Down Line space for maintenance within Bus Parking.
12. After maintenance, the bus is returned to the Bus Parking area.

**Note: Traffic flow should ideally be in a counterclockwise direction.**

## SUPPORT VEHICLES

Traffic other than transit vehicles, (forklifts, delivery trucks, off site agency vehicles servicing site and private non-agency service vehicles) circulates between designated parking areas and the maintenance, service, and any yard storage.

### EMPLOYEE VEHICULAR TRAFFIC

Vehicles of employees should be restricted to employee parking areas. Employee parking areas should be located on the site in close proximity to their respective entrances to the Drivers' Room in Operations and to the restroom areas in Maintenance.

### COMMERCIAL VEHICULAR TRAFFIC

Commercial vehicles must be directed onto and from the site by appropriate signs, following the same traffic flow as transit vehicles. Those vehicles delivering to Parts Storage require off-loading at the Shipping and Receiving area of Parts Storage. Other vehicles delivering bulk consumables, such as fuels and engine oil, require off-loading adjacent to the tank farm or adjacent to the Lube Room. Tanker trucks may also arrive to evacuate tanks and collect recyclable liquids. Vehicles will pick up trash from dumpsters located on the site. Scrap dealers may enter the site to pick up segregated and non-segregated metal scrap.

Other companies providing services, products, or a combination of both may create additional traffic, e.g., delivery of tires, delivery of advertising materials for the exterior and interior of vehicles, laundry service, bulk storage, and service contracts with companies maintaining specific facility equipment.

## PEDESTRIAN TRAFFIC

Routine activities generate a substantial volume of pedestrian traffic. Many of these trips require maintenance personnel to walk the length of the bus parking area to pick up a vehicle or to return to a workstation after parking a vehicle. Pedestrian walkways should be designed to minimize walking distances, trip times, and exposure of personnel to vehicular traffic. Those areas personnel most frequently walk to or through are:

- From the Employee Parking Area to the entrance doors of Maintenance.
- From the Employee Parking Area to the entrance door of the Drivers' Room.
- From the Drivers' Room to the Agency Vehicle Parking Area.
- From Maintenance to Fuel & Wash.
- From Fuel & Wash to the Agency Vehicle Parking Area.
- From the Maintenance Area to the Agency Vehicle Parking Area.

## OUTSTANDING ISSUES

- Should Utility personnel counts only be included with Fuel and Wash but physically located in Maintenance shop areas?
- Confirmed staffing counts for each department.
- Yuba-Sutter furniture standards for offices and workstations.
- Type of back-up generators for Battery Electric Bus.
- Anticipated AM pull out hours, PM pull in hours, and service hours to determine greatest amount of intra-site traffic, under Daily Activities on page 1.5.p

# SPACE NEEDS PROGRAM

---

## INTRODUCTION

The preliminary space program presented herein was developed based on detailed interviews with Yuba-Sutter Transit staff regarding the functional requirements and operating characteristics of the bus operating garage.

The space requirements shown for each functional are net usable area. A circulation factor is applied to the total net usable area to arrive at a gross square footage requirement. In addition to circulation, the factor provides for spaces such as mechanical and electrical chases, structure, width of walls, and stairs. The Space Program begins with an overall summary followed by a detailed program for each functional area. Note that the requirements for each space are delineated in Chapter 3, the Functional Requirements section of this document in the same order they appear in the Space Program.

The program includes the following information for each space.

<b>Space Name</b>	The name of the space. [A] - Alcove Space [C] - Canopy Covered [E] - Enclosed Space [O] - Open Office or Shop Space [X] - Exterior Space
<b>Space Standard</b>	The standard for each space based on the function, equipment, and furnishings to be accommodated. The standards are given in square feet. Where the configuration of the space is critical, dimensions are given for the space. The size of the repair bays are commonly accepted industry standards.
<b>Reference</b>	Indicates the page number in chapter 3 that fully describes the functional requirements of the space. This Reference column will be included with the FINAL version of the Design Criteria and is not included in the DRAFT version.
<b>Remarks</b>	Lists additional information about the space.
<b>Existing 2020</b>	Shown to provide a quick comparison of total existing space (2020) versus proposed area (2030 and 2040). Includes existing staff, quantity and size of spaces as counted and measured from the existing facility as-builts.
<b>2030 &amp; 2040</b>	Specific time periods. 2030 represents the initial construction of a new Yuba Sutter Transit facility. 2040 represents maximum growth and anticipated for future expansion.
<b>Staffing</b>	Anticipated staff to be accommodated during the specific time period
<b>Quantity</b>	Identifies the number of spaces to be accommodated during a specific time period.
<b>Space</b>	Area in square feet for the proposed space. Note that where a space standard is given, the area equals the space standard times the quantity.



**YUBA-SUTTER TRANSIT  
PRELIMINARY SPACE NEEDS PROGRAM**

Marysville, CA

June, 2020

45 ft transit commuter	13	Diesel	17	Diesel	22	BEB / FC
35 ft transit coaches	22	Diesel	24	Diesel	28	BEB / FC
24-25 ft Shuttles	16	Unleaded	20	Unleaded	20	BEB / FC
Non Revenue Vehicles	1	Diesel	2	Diesel	13	BEB / FC
Non Revenue Vehicles	5	Unleaded	8	Unleaded	2	BEB / FC
<b>Total Agency Vehicles</b>	<b>57</b>		<b>71</b>		<b>85</b>	

[E] = Enclosed, [O] = Open/Workstation, [A] = Alcove,

[C] = Canopy covered, [X] = Outdoors (exterior)

Space Name	Space Standard		Ref.	Remarks	Existing 2020			2030			2040			
	dims	sf			Staffing	Qty	Space	Staffing	Qty	Space	Staffing	Qty	Space	
<b>SUMMARY</b>														
<b>SUMMARY - Building spaces</b>														
ADMINISTRATION					5		2,226	12		6,693	17		6,888	
OPERATIONS / DRIVERS					79		3,463	91		8,043	98		8,043	
MAINTENANCE					7		12,772	10		15,120	13		15,120	
PARTS STOREROOM					1		2,400	1		5,238	1		5,238	
FUEL / WASH / SERVICE					7		6,115	11		7,447	13		7,447	
<b>SUMMARY - Building spaces TOTALS</b>					<b>99</b>		<b>26,976</b>	<b>125</b>		<b>42,541</b>	<b>142</b>		<b>42,736</b>	
<b>SUMMARY - Outdoor spaces</b>														
AGENCY VEHICLE PARKING						57	80,720		71	89,000		85	106,000	
EMPLOYEE / VISITOR PARKING						95	25,365		121	48,900		141	57,100	
OTHER SITE AREAS							5,462			4,640			4,640	
<b>SUMMARY - Outdoor spaces TOTALS</b>							<b>111,547</b>			<b>142,540</b>			<b>167,740</b>	
<b>Site Circulation</b>					75%		To be verified during detailed design			106,905			125,805	
<b>Lanscaping / Site Setback</b>					10%		To be verified during detailed design			14,254			16,774	
<b>Stormwater Management</b>					25%		To be verified during detailed design			35,635			41,935	
<b>TOTAL SITE REQUIREMENTS (SF)</b>							<b>138,523</b>			<b>335,182</b>			<b>388,102</b>	
<b>TOTAL SITE REQUIREMENTS (ACRES)</b>							<b>3.18</b>			<b>7.69</b>			<b>8.91</b>	

Space Name	Space Standard		Ref.	Remarks	Existing 2020			2030			2040			
	dims	sf			Staffing	Qty	Space	Staffing	Qty	Space	Staffing	Qty	Space	
<b>ADMINISTRATION</b>														
Entry Vestibule	8 X 7	56	3.8	Contain two double doors in a series sized to allow first door to shut prior to second door opening.		1			1	56		1	56	
Lobby	17 X 25	425	3.9	Seating for up to 8 and floor space for 2 power chairs. View of Lobby from Office / Counter Assistant position.		1	150		1	425		1	425	
Unisex Restroom - Public	8 X 8	64	3.10	Accessible from customer Lobby.					1	64		1	64	
Administration				Secure access to office suite.										
Transit Manager	12 X 14	168	3.11	Guest seating for up to 2.	1	1	191	1	1	168	1	1	168	
Assistant Transit Manager	12 X 12	144	3.11						1	144	1	1	144	
Planning Program Manager	12 X 12	144	3.12		1	1	144	1	1	144	1	1	144	
Finance Program Manager	12 X 14	168	3.12	Guest seating for up to 2.	1	1	168	1	1	168	1	1	168	
Administrative Suite	45 X 38	1,710	3.13			1	395		1	1,710		1	1,710	
Counter	12 X 6	72	3.14						1			1		
Program Analyst	8 X 9	72	3.14		1	1	72	3	3		4	4		
Administrative Assistant	8 X 9	72	3.15		1	1	72	2	2		2	2		
Office / Counter Assitant	8 X 9	72	3.15					2	2		2	2		
Marketing & Outreach Specialist	8 X 9	72	3.16					1	1		2	2		
Current Files	10 X 10	100	3.16	Stored in file cabinets within Administrative Suite.		1	100		1			1		
Lost & Found Cabinet	6 X 6	36	3.17	Secure storage for issuing to public		1	36		1			1		
Program Manager (Undefined)	12 X 12	144	3.17								1	1	144	
IT Specialist	15 X 19	285	3.18					1	1	285	2	1	285	
Conference Room - Small	10 X 18	180	3.19	Accommodate up to 10 people. Adjacent to Lobby with access to Administration suite.		1	183		1	180		1	180	
Copy / Work Room	15 X 20	300	3.20	Multi-function copier and storage cabinets.		1	161		1	300		1	300	
Storage Room	12 X 16	192	3.21	Administrative storage closet		1	192		1	192		1	192	
Archive File Storage	15 X 18	270	3.22	Records stored in file boxes on shelves. 114 existing, design for 150. Floor space storage of marketing materials, bus stop signs, folding tables, pop-up canopies, etc.		1	270		1	270		1	270	
Break Room	16 X 18	288	3.23	Sink, full fridge, 2 microwaves, coffee maker.					1	288		1	288	
Quiet Room	8 X 12	96	3.24						1	96		1	96	
Unisex Restroom	8 X 8	64	3.25	Serves the Administration Suite.		2	150		2	128		2	128	
Custodial	10 X 10	100	3.26	Mop sink, shelving, storage cabinet.					1	100		1	100	
Telephone / Server / AV Equipment Room	15 X 16	240	3.27	Dedicated A/C and good air flow. Shared space by Yuba-Sutter Transit and STORER Transit Systems.		1	92		1	240		1	240	

Subtotal						2,376			4,958			5,102
Circulation	35%					832			1,735			1,786

<b>ADMINISTRATION TOTALS</b>						5		3,208	12		6,693	17		6,888
------------------------------	--	--	--	--	--	---	--	-------	----	--	-------	----	--	-------

Space Name	Space Standard		Ref.	Remarks	Existing 2020			2030			2040			
	dims	sf			Staffing	Qty	Space	Staffing	Qty	Space	Staffing	Qty	Space	
<b>OPERATIONS / DRIVERS</b>														
<b>Operations</b>														
General Manager	E	12 X 16	192	3.30	Guest seating for up to 2 with additional space for up to 4.	1			1	1	192	1	1	192
Operations Manager	E	12 X 12	144	3.30		1		105	1	1	144	1	1	144
Office Manager	E	12 X 12	144	3.31		1			1	1	144	1	1	144
Operations Suite	E	26 X 28	728	3.22	To include a table to be used as a common work space.						728			728
Assistant Operations Manager	O	8 X 9	72	3.33		1			1	1		1	1	
Safety Manager	O	8 X 9	72	3.33		1			1	1		1	1	
Trainer	O	8 X 9	72	3.34					1	1		1	1	
Road Supervisors	O	8 X 9	72	3.34		2			3	2		3	2	
File Storage	O			3.35	(2) Four drawer lateral file cabinets stored within Operations Suite					2			2	
Expansion Office	E	12 X 12	144	3.35						1	144		1	144
Storage Room	E	9 X 12	108	3.36						1	108		1	108
Long Term Storage - Large	E	12 X 14	168	3.37						1	168		1	168
Coin Room	E	10 X 12	120	3.38	Secure space for coin counting		1	90		1	120		1	120
<b>Dispatch</b>														
Entry Vestibule	E	8 X 7	56	3.39						1	56		1	56
Lobby - Dispatch	E	10 X 10	100	3.40	Seating for 2 people. Pre-wire for potential future applications workstation.					1	100		1	100
Dispatch Suite	E	24 x 28	672	3.41	(2) Dispatchers and (2) Customer Service Representatives per shift.			286		1	672		1	672
Dispatch Window (Dispatcher)	O	6 X 6	36	3.42	Min 6 feet between dispatchers.	5	1		6	4		6	4	
Customer Service Representative	O	6 X 6	36	3.42		1			4	2		4	2	
Lost & Found Daily Collect	O	3 X 5	15	3.43	Shelving to hold daily containers					1			1	
Storage	O	4 X 3	12	3.43	Closet for Dispatch storage					1			1	
Copy / Work Room	E	10 X 12	120	3.44			1	18		1	120		1	120
Conference - Small	E	12 X 18	216	3.45	To accommodate up to 10 people		1	216		1	216		1	216
Training / Large Conference Room	E	12 X 18	216	3.46	Seat 8 w/ train tbl + low credenza			380		1	216		1	216
Table and Chair Storage	E	6 X 8	48	3.47						1	48		1	48
<b>Driver Areas</b>														
Driver Check-In	O	8 X 14	112	3.48	CPU for self check-in 2 people at a time + (1) document board		1	57		1	112		1	112
Driver Mailboxes	O	3 x 10	30	3.49	Lockable mailboxes. Fill from front.		1	32		1	30		1	30
Drivers Room	E	20 X 27	540	3.50	Tables and chairs, couches to seat 21, (2) lockable wall hung display boards, and (7) corkboards	66	1	781	72	1	540	79	1	540
Recreation Area	O	20 X 20	400	3.51	(1) Game table					1	400		1	400
Kitchenette / Vending	A	10 X 35	350	3.52	Upper / lower cabs. Single basin sink, (4) microwaves, (2) coffee machine, (4) vending machines, (2) refrigerator, (1) oven with stovetop, ice machine, and dishwasher.					1	350		1	350
Quiet Room	E	10 X 12	120	3.53	(4) Lounge chairs. Accoustically isolate from other areas.		1	120		1	120		1	120

Space Name	Space Standard		Ref.	Remarks	Existing 2020			2030			2040			
	dims	sf			Staffing	Qty	Space	Staffing	Qty	Space	Staffing	Qty	Space	
<b>OPERATIONS / DRIVERS</b>														
<b>Operations</b>														
Lactation / Sick Room	E	10 X 10	100	3.54	Mini fridge, (1) lounge chair.					1	100		1	100
Unisex Toilet / Shower / Drug Test Room	E	10 X 13	200	3.55	(1) Water closet, (1) shower, changing bench					1	200		1	200
Men's Restroom	E	12 X 20	240	3.56	(3) WC, (3) Urinals, (3) Lav. Confirm fixture count during detailed desging.		1	228		1	240		1	240
Women's Restroom	E	12 X 20	240	3.57	(4) WC, (3) Lav. Confirm fixture count during detailed desging.		1	228		1	240		1	240
Custodial / Storage	E	10 X 15	150	3.58	Mop sink, shelving, storage cabinet					1	150		1	150
Mechanical	E		200	3.59	Size to be verified during detail design					1	200		1	200
Electrical	E		100	3.59	Size to be verified during detail design					1	100		1	100
Subtotal								2,541			5,958			5,958
Circulation						35%		889			2,085			2,085
<b>OPERATIONS / DRIVERS TOTALS</b>									79		3,430	91		8,043

Space Name	Space Standard		Ref.	Remarks	Existing 2020			2030			2040			
	dims	sf			Staffing	Qty	Space	Staffing	Qty	Space	Staffing	Qty	Space	
<b>MAINTENANCE</b>														
Office Spaces														
Maintenance Manager	E	12 X 14	168	3.62	View of shop floor.	1	1	211	1	1	168	1	1	168
Mechanic Workstation (Mechanics)	O	6 X 12	72	3.63	Seats 2 mechanics with 2 CPUs	6	2	72	8	1	72	10	1	72
Maintenance Break Room	E	16 X 18	288	3.64	Seating for up to 6 at tables and chairs, refrigerator, (2) microwaves, plumb water for coffee makers, sink		1	158		1	288		1	288
Men's Restroom	E	12 x 20	240	3.65	2 WC, 2 Urinals, 2 Lavatories, 1 deep basin sink with gooseneck faucet+ Bradley sink.		1	64		1	240		1	240
Women's Restroom	E		140	3.66	2 WC, 2 Lavatories, 1 deep basin sink with gooseneck faucet + Bradley sink.					1	140		1	140
Unisex Shower	E		64	3.67	Includes changing area.		1	63		1	64		1	64
Lockers	A		100	3.68	Shared by Men and Women Maintenance personnel, bench, and (20) half height lockers		1	147		1	100		1	100
Maintenance Records	E	10 X 8	80	3.69	(105) storage boxes on shelves					1	80		1	80
Custodial	E	10 X 10	100	3.70	Mop sink, shelving, storage cabinet.					1	100		1	100
Shop Spaces														
Lift Bay (45 ft Bus)	O	20 X 60	1,200	3.72	Parallelogram or verticle rise lift. Fall protection bean & hoist.			4,712		2	2,400		2	2,400
Flat Bay(45 ft Bus)	O	20 X 60	1,200	3.74	Portable lifts. Fall protection beam & hoist. Festoon for portable lift cables.		5	6,000		2	2,400		2	2,400
Air Conditioning Bay (45 ft Bus)	O	20 X 60	1,200	3.76						1	1,200		1	1,200
Tire Bay / Storage	E	20 X 60	1,200	3.78	Acoustically isolated. Storage for bus tires on stackable racks.					1	1,200		1	1,200
Common Work Area	E	25 X 30	750	3.80			1	192		1	750		1	750
Electronics Shop	E	18 X 30	540	3.82	Shop space for electric bus charging cabinet repair.					1	540		1	540
Electrician	O	4 X 15	60	3.82					1	1	60	2	1	60
Tool Box Storage	E	25 X 16	400	3.84	Enclosed secure area for storage of (10) tool boxes.					1	400		1	400
Forklift Parking	O	14 X 10	140	3.85						1	140		1	140
Floor Scrubber Parking	O	6 X 5	30	3.86	With charging and hub drain.					1	30		1	30
Portable Equipment Storage	O	20 X 60	1,200	3.87	Portable CG (2), portable differential (1).					1	1,200		1	1,200
Waste Fluid Collection	C	12 X 14	168	3.88	WO (1), WC (1).					1	168		1	168
Battery Room	X	10 X 20	200	3.88	Exterior pre-fab haz-mat building. Contain charging and new / used battery storage. (1) pallet each.					1	200		1	200
Lube / Compressor Room	E	18 X 20	360	3.90	Includes bulk fluid distribution for ATF, EC, EO1, and EO2. Accousically isolated.		1	245		1	360		1	360
Mechanical Room	E		200	3.92	Size to be verified during detail design					1	200		1	200
Electrical Room	E		100	3.92	Size to be verified during detail design					1	100		1	100
Subtotal							11,864			12,600			12,600	
Circulation					20%		2373			2520			2520	
<b>MAINTENANCE TOTALS</b>							<b>14,237</b>			<b>15,120</b>			<b>15,120</b>	
							<b>7</b>			<b>10</b>			<b>13</b>	

Space Name	Space Standard		Ref.	Remarks	Existing 2020			2030			2040					
	dims	sf			Staffing	Qty	Space	Staffing	Qty	Space	Staffing	Qty	Space			
<b>PARTS STOREROOM</b>																
Lobby	E	10 X 10	100	3.94	Seating for 2.		1	95		1	100		1	100		
Parts Clerk	E	12 X 15	180	3.95		1	1	115	1	1	180	1	1	180		
Parts Storeroom			1,800	3.96				975		1	1,800		1	1,800		
Warranty Storage	O	8 X 30	240	3.98	On shelving racks within Parts Storeroom					1			1			
Tool Crib	O			3.98	(2) lockable storage cabinets within Parts Storeroom					1			1			
Shipping and Receiving	O	20 X 20	400	3.99	Within Parts Storeroom					1	400		1	400		
Loading Area	C	30 X 60	1,800	3.99	Space for 2 delivery trucks					1	1,800		1	1,800		
Mezzanine Storage	O		2,000	3.100	With forklift access		1	2,260		1	2,000		1	2,000		
Subtotal								1,185			3,880			3,880		
Circulation					35%			415			1,358			1,358		
<b>PARTS STOREROOM TOTALS</b>								1		1,600	1		5,238	1		5,238
<b>FUEL / WASH / SERVICE</b>																
<b>Fueling</b>																
Fueling Position	C	20 X 55	1,100	3.102	2 diesel fueling positions		2	2,802		2	2,200		2	2,200		
Vault Pull / Fare Collection	C			3.104	At each fueling position											
Utility Workstation	A	6 X 6	36	3.105	Workstation for (1) Supervisor and (6) Utility Technicians.	7	1		9	2	72	11	2	72		
Central Vacuum	E	10 X 15	150	3.106	Sized to use 2 ports simutanously. Vacuum ports at fuel position and in Bus Wash / Detail Clean.					1	150		1	150		
Unisex Restroom	E	8 X 8	64	3.107	If fueling not located near Maintenance Building					1	64		1	64		
<b>Wash</b>																
Automatic Bus Washer / Detail Clean	E	22 X 65	1,430	3.108	Gantry style bus washer			1,497		1	1,430		1	1,430		
Water Reclaim	E	10 X 20	200	3.110				286		1	200		1	200		
Bus Detail Lane	C	20 X 65	1,300	3.108	At Fuel Positions & in Bus Wash											
Cleaning Storage	E	10 X 10	100	3.111						1	100		1	100		
Chassis Wash	C	20 X 65	1,300	3.112	Parallelogram lift. Located outside under canopy.					1	1,300		1	1,300		
Chassis Wash Equipment	E			3.114	Stored inside Water Reclaim room					1			1			
Subtotal								4,585			5,516			5,516		
Circulation					35%			1,605			1,931			1,931		
<b>FUEL / WASH / SERVICE TOTALS</b>								7		6,190	11		7,447	13		7,447

Space Name	Space Standard		Ref.	Remarks	Existing 2020			2030			2040					
	dims	sf			Staffing	Qty	Space	Staffing	Qty	Space	Staffing	Qty	Space			
<b>AGENCY VEHICLE PARKING</b>																
Ready Line			3.115	Provide solar canopy over all Revenue parking. Provide for charging in parked position for all vehicles.												
45 ft transit commuter	14 X 50	700		Added 5ft to vehicle length for circulation around vehicle		13	9,100		17	11,900		22	15,400			
35 ft transit coaches	14 X 50	700		Park in space sized for 45 ft bus		22	15,400		24	16,800		28	19,600			
24-25 ft Shuttles	14 X 30	420		Added 5 ft to vehicle length for circulation around vehicle		16	6,720		20	8,400		20	8,400			
Non Revenue Vehicles	10 X 20	200	3.115			6	1,200		10	2,000		15	3,000			
Down Line	12 X 50	600	3.116	Sized for 45 ft coaches					9	5,400		11	6,600			
Subtotal							32,420			44,500			53,000			
Circulation					100%		32,420			44,500			53,000			
<b>AGENCY VEHICLE PARKING TOTALS</b>								57		64,840	80		89,000	96		106,000
<b>EMPLOYEE / VISITOR PARKING</b>																
Employee Parking			3.117	SF shown allows schematic layout of spaces to accommodate ADA and landscape / island requirements												
Administration	10 X 20	200				5	1,000		12	2,400		17	3,400			
Operations / Drivers	10 X 20	200		Drivers parking space count = bus qty - spare + 5% for overlap and driver standbys + Ops staff		73	14,600		83	16,600		93	18,600			
Maintenance / Parts	10 X 20	200				8	1,600		11	2,200		14	2,800			
Fuel / Wash / Service	10 X 20	200				7	1,400		11	2,200		13	2,600			
Visitor Parking	10 X 20	200	3.117			2	400		4	800		4	800			
Motorcycle Parking	5 X 10	50	3.118			2	100		4	200		6	300			
Bike Parking		50	3.118	Hold 7 bicycles - shared employee and visitors.		1	50		1	50		1	50			
Subtotal							19,150			24,450			28,550			
Circulation					100%		19,150			24,450			28,550			
<b>EMPLOYEE / VISITOR PARKING TOTALS</b>								38,300		48,900			57,100			

Space Name	Space Standard		Ref.	Remarks	Existing 2020			2030			2040			
	dims	sf			Staffing	Qty	Space	Staffing	Qty	Space	Staffing	Qty	Space	
<b>OTHER SITE AREAS</b>														
Outdoor Break Area	C	30 X 30	900	3.119	Canopy covered area with BBQ pit and picnic tables.					1	900		1	900
Storage Area for Outdoor Break Area	E	10 x 10	100		Storage of BBQ pit and other outdoor supplies.					1	100		1	100
Above Ground Diesel Tank	X	45 X 10	450	3.120	15,000 gallons with secondary containment, adjacent to Fuel Island with no underground fuel piping.					1	450		1	450
Building Back-Up Generator	X	50 x 15	750	3.120	Existing to be relocated to new site.					1	750		1	750
Future Pre-Comp. Hydrogen Modular Trailers	X	12 x 50	600	3.121	Dispenses 350 bars.					1			1	
Future Hydrogen Electrolizer Modular Trailer	X	12 x 50	600	3.121	Makes 350 bars per day.									
Future Hydrogen Compressor Yard	X		3,500	3.122						1			1	
BEB Charge Equipment Yard	X		7,200	3.122						1			1	
BEB Charging Back-Up Generator	X	50 x 15	750	3.123	2 Generators based on full BEB ready fleet.					2			2	
Dumfter / Waste				3.124										
Trash	C	6 X 5	30		4 CY box container		1	30		1	30		1	30
Metals	C	6 X 5	30		4 CY box container		1	30		1	30		1	30
Cardboard	C	6 x 5	30		4 CY box container		1	30		1	30		1	30
Organics	C	6 X 5	30		4 CY box container					1	30		1	30
Subtotal							90			2,320			2,320	
Circulation					100%		90			2,320			2,320	
<b>OTHER SITE AREAS TOTALS</b>							180			4,640			4,640	



# FUNCTIONAL RELATIONSHIP DIAGRAMS AND FUNCTIONAL AREA MODULES

## INTRODUCTION













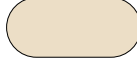

The design criteria presented in this section consists of Functional Relationship Diagrams and Functional Area Modules. The Functional Relationship Diagrams illustrate the relationships between areas listed in the Space Needs Program. The Functional Area Modules consist of a graphical depiction along with specific design criteria for each of the spaces listed in the Space Needs Program.

### Office Modules

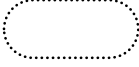
The space standards for offices established in the Space Needs Program are graphically defined on the following pages. All modules and related furnishings and equipment are for representation purposes only. Detailed layouts and specific furnishings will be developed during detailed design.

### Diagrams

The relationships between various functional areas of the Space Needs Program are conveyed in the diagrams on the following pages. These diagrams, both Adjacency and Functional Area Modules, are not meant to be floor plans, only representational relationship diagrams.

<u>Adjacency Diagram Line</u> <u>Type Key</u>	<u>Adjacency Diagram Space</u> <u>Type Color Key</u>	<u>Functional Area Modles</u> <u>Element Key</u>
 Enclosed Spaces	 Office / Administrative Spaces	 Walls
 Open Spaces or Alcoves	 Shops / Workspaces	 Floors
 Exterior / Covered Spaces	 Circulation / Public / MEP Spaces	 Shop / Vehicle Maintenance Equipment
 Area of Associated Spaces	 Storage / Equipment Spaces	 Site Built Fixtures, Furnishings, and Equipment (FFE)
	 Driver / Crew Spaces	 Interior FFE
	 Bay Spaces (Vehicle)	 Mounted Overhead (3D View Only)

Workstation 1A (36 square feet)

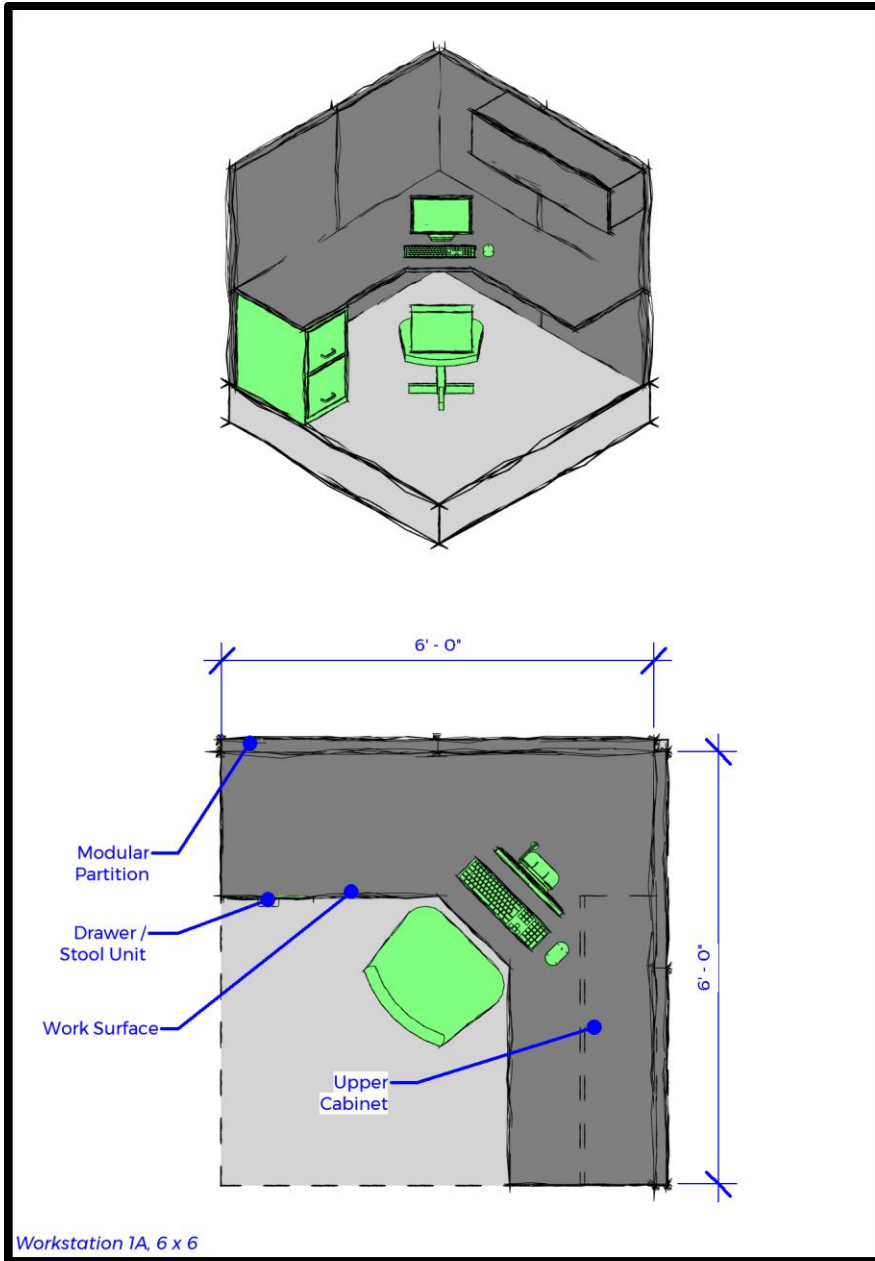

Workstation 1B (72 square feet)

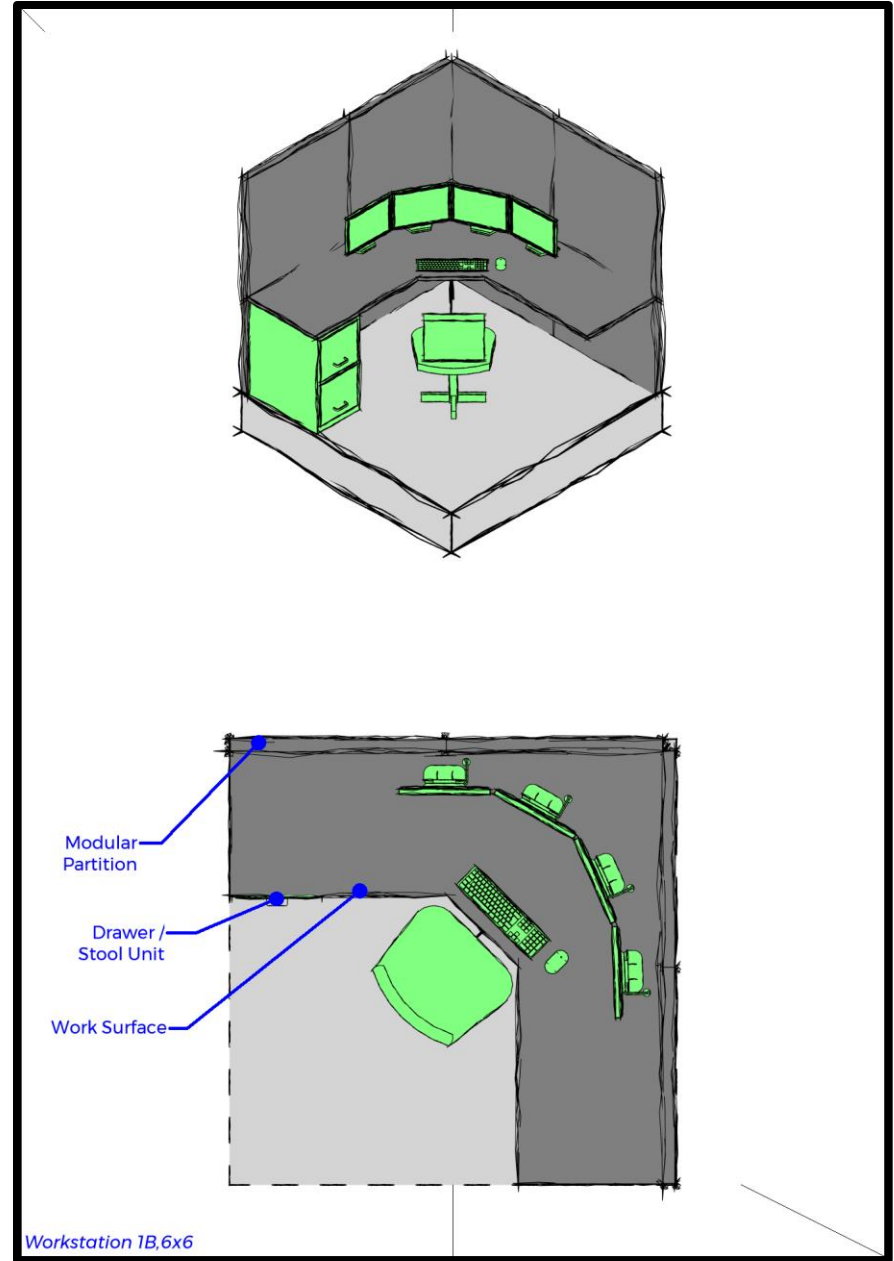

Workstation 2A (72 square feet)

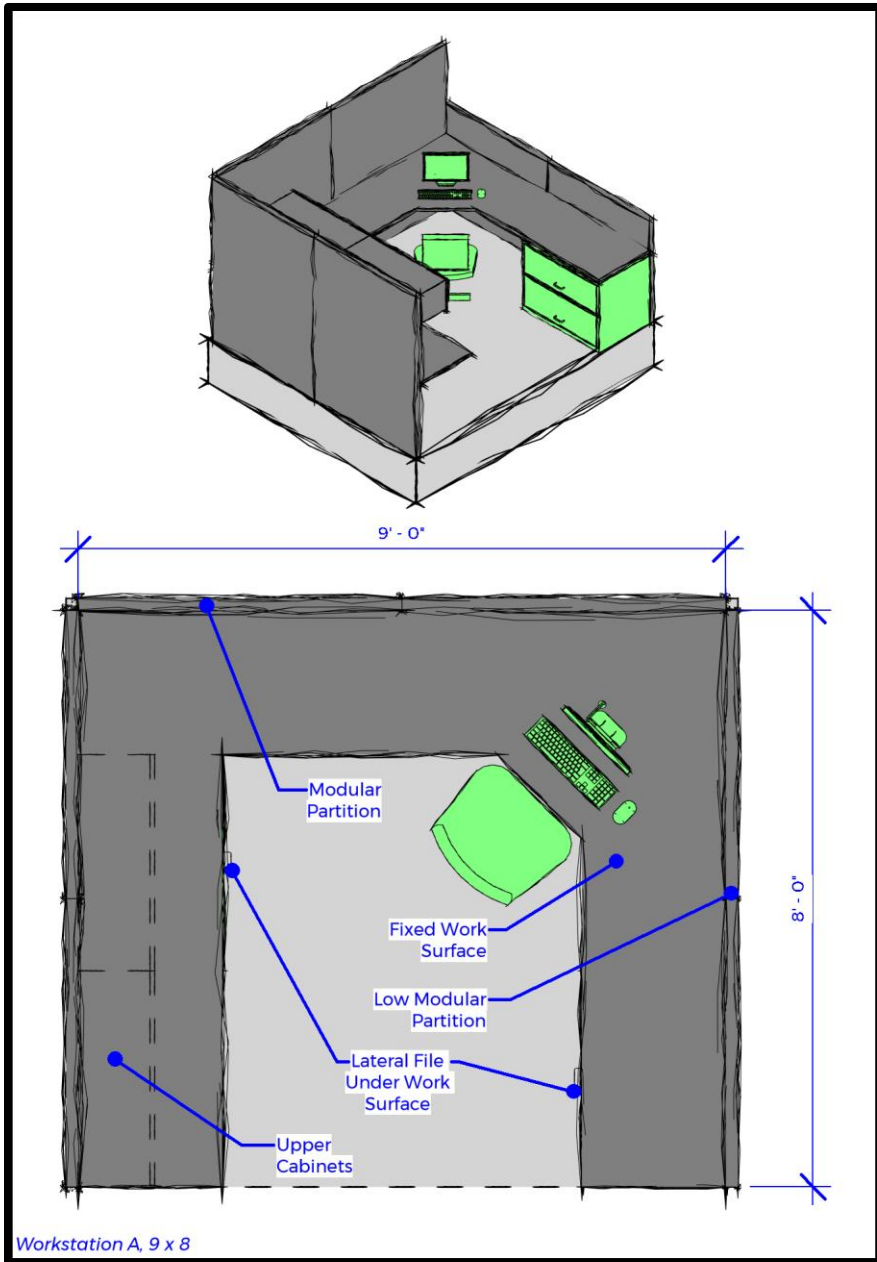

Module 2B (72 square feet)

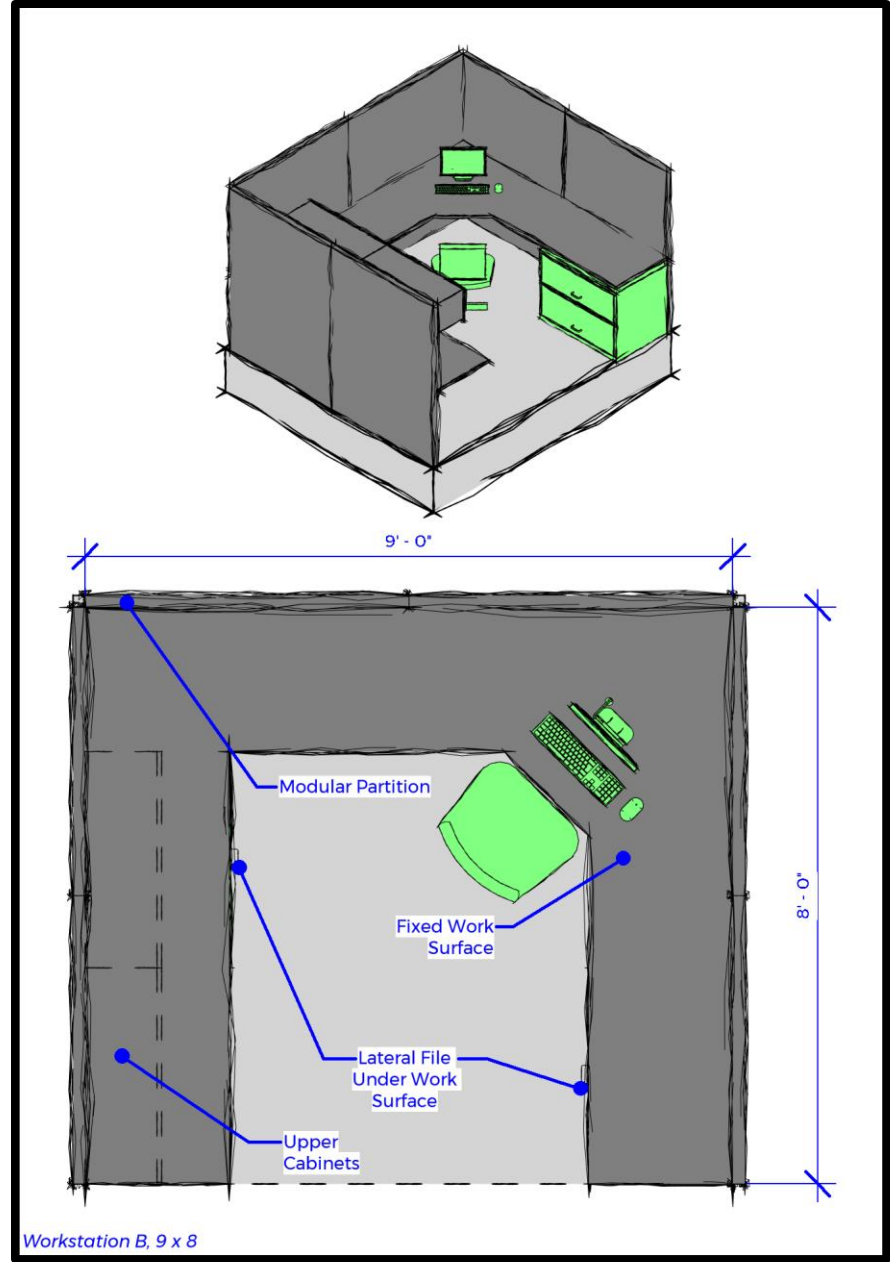

Module 1 (144 square feet)

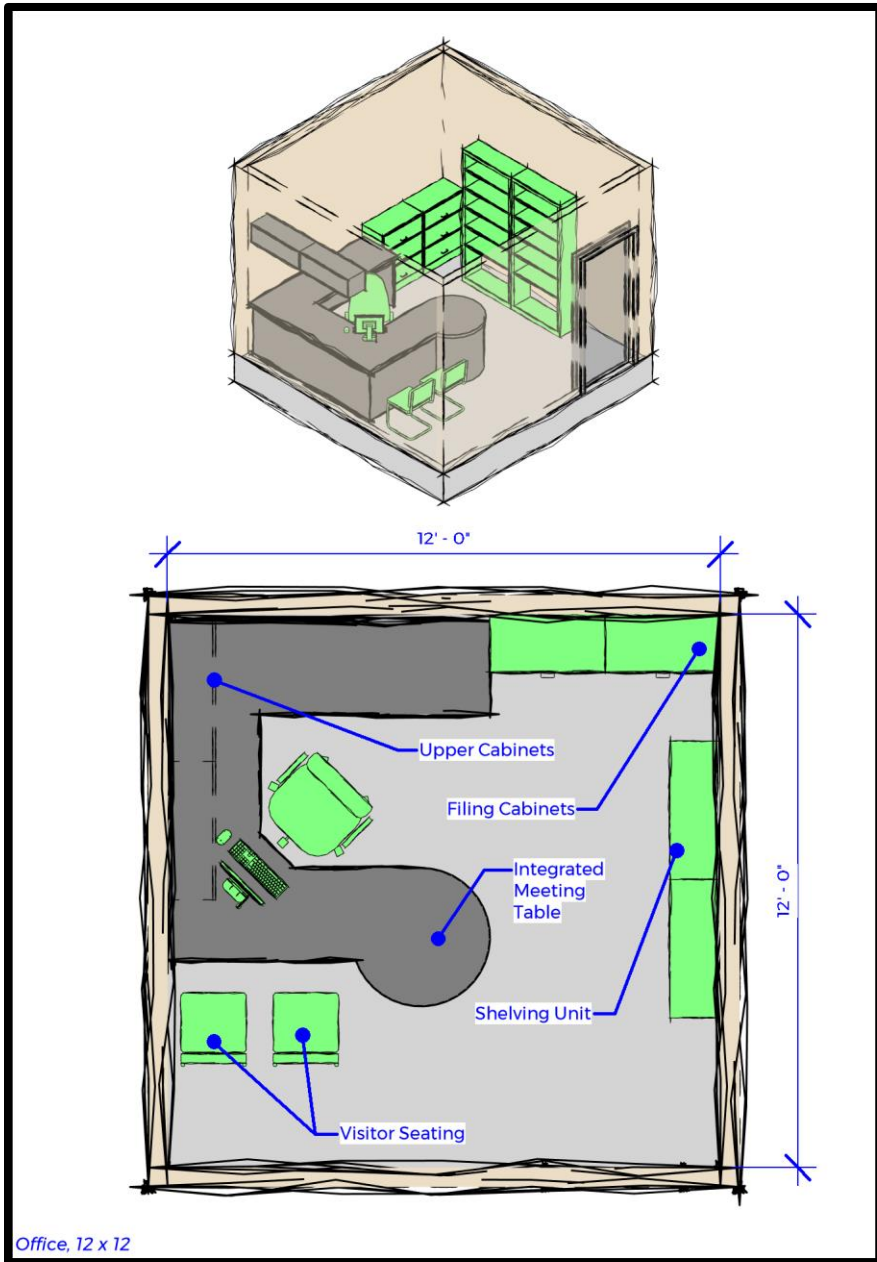

Office, 12 x 12

Module 2 (168 square feet)

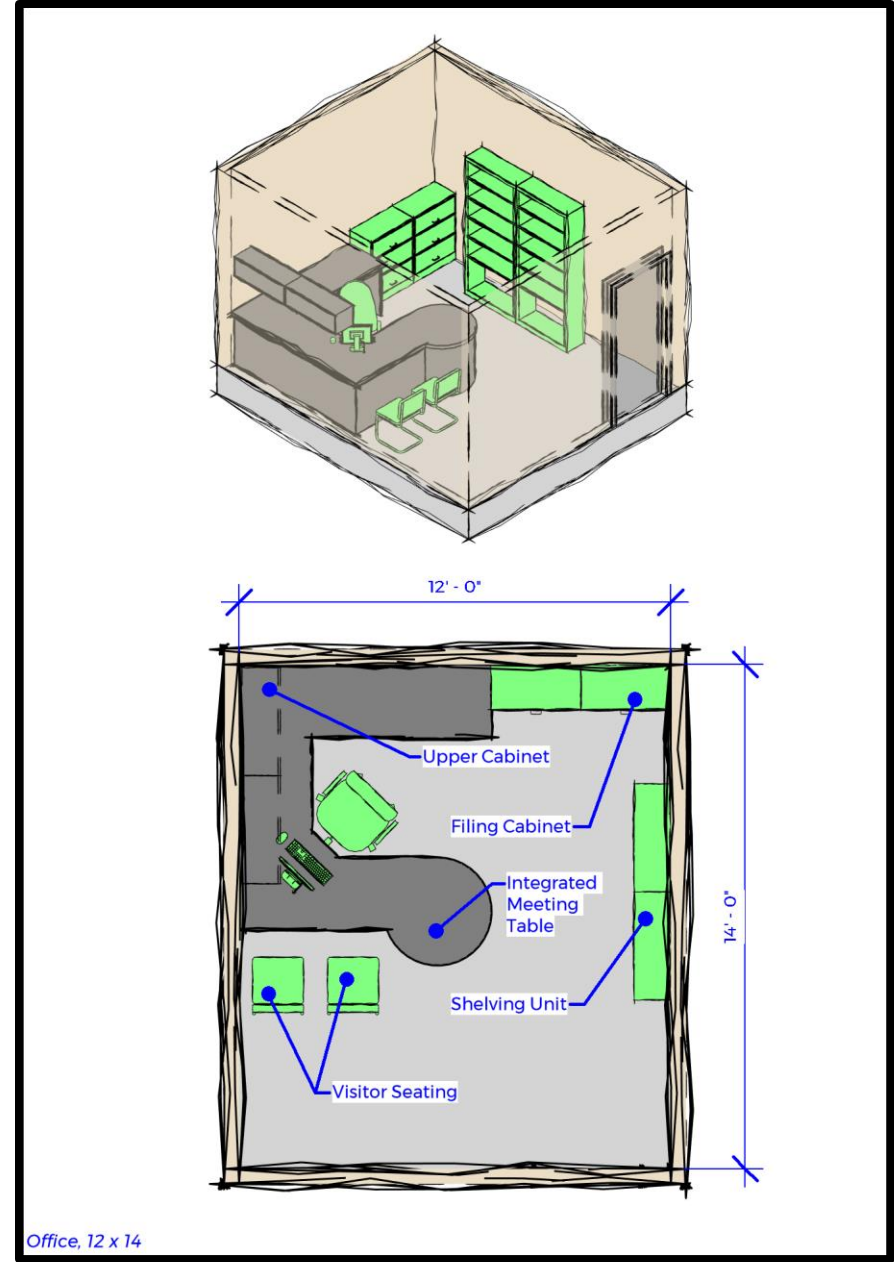

Office, 12 x 14

Module 3 (192 square feet)

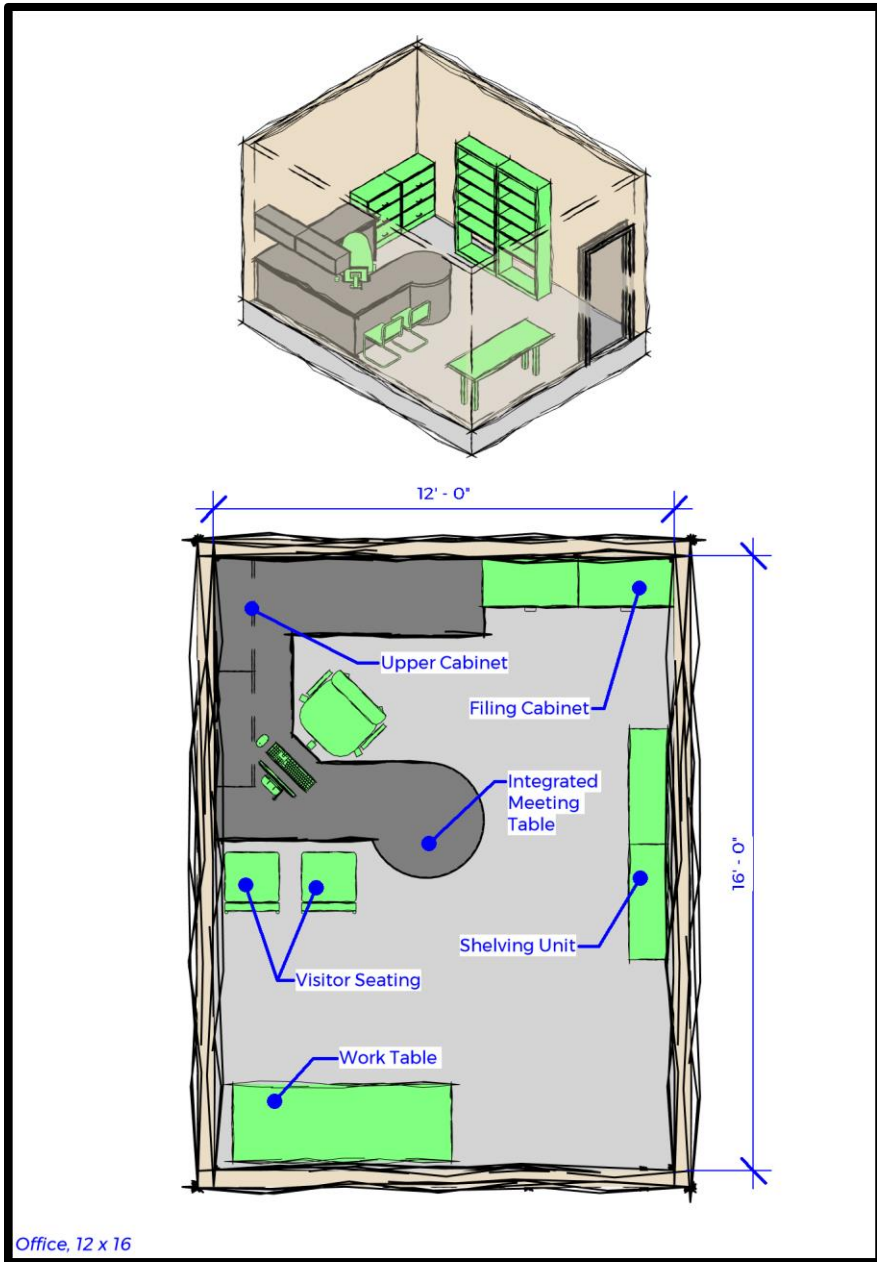

Office, 12 x 16

**THIS PAGE INTENTIONALLY LEFT BLANK**



## ADMINISTRATION

### FUNCTIONAL RELATIONSHIP DIAGRAM

The relationships between the spaces within this section are shown below. The design should accommodate these relationships in order to maximize operational efficiency. This diagram is not meant to be a floor plan. It serves only as a representational relationship diagram.

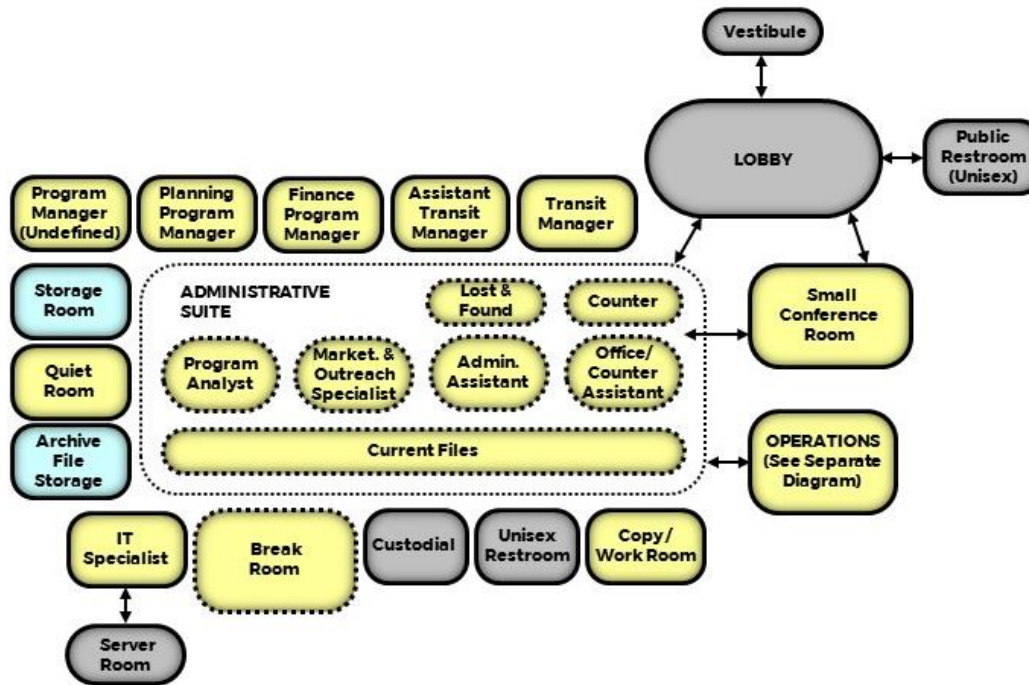

### FUNCTIONAL AREA MODULES

Each functional area within this section has been individually defined as a module. Each module has information regarding the function of the space, relationships to other areas and other information received during interviews with Yuba-Sutter Transit staff.

## ENTRY VESTIBULE

(ADMINISTRATION)

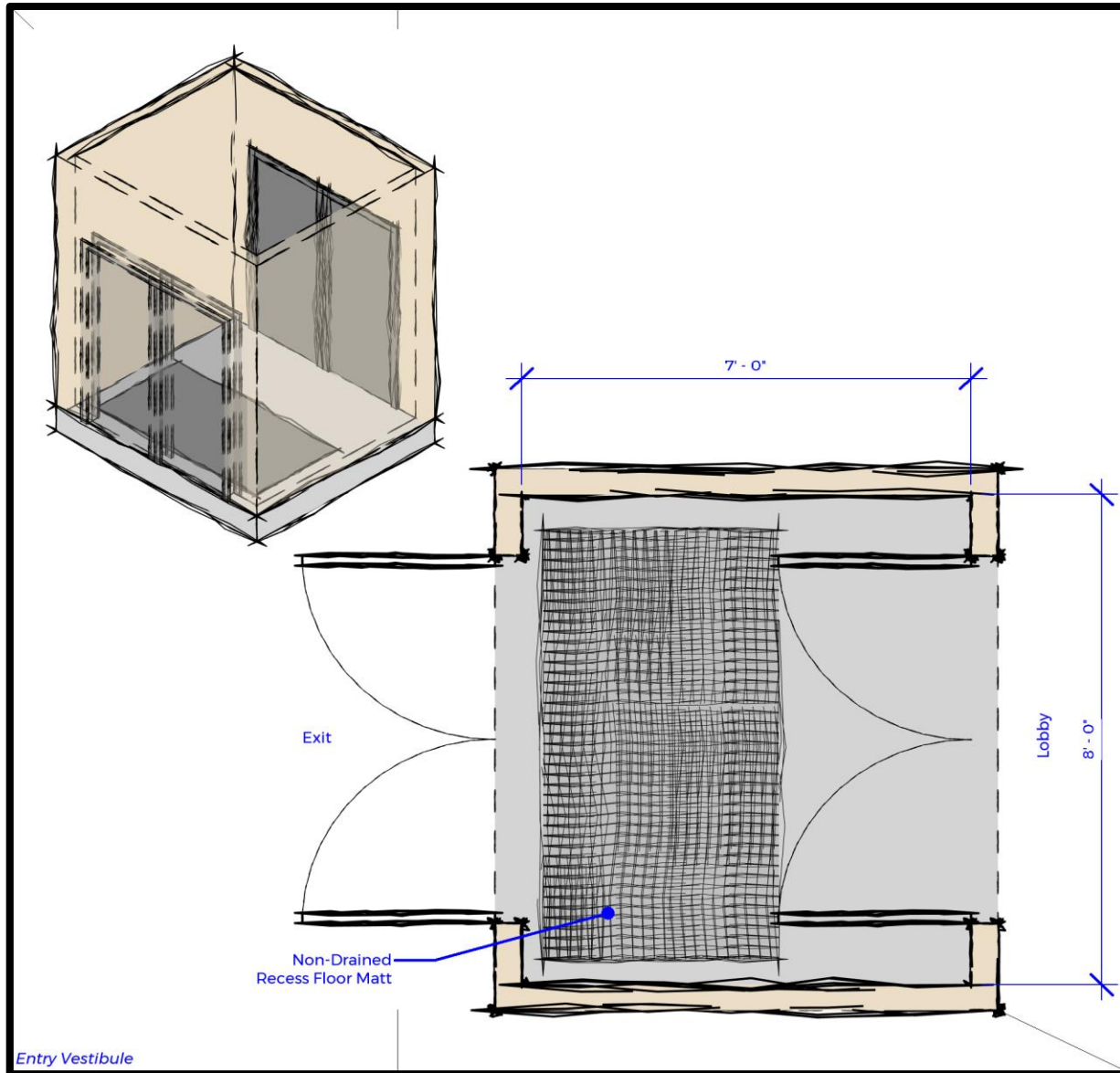

### Function

- Entry area before Lobby.

### Relationship to other Areas

- At entrance of Administration.

### Comments/Characteristics

- Furnishings: None.
- Utility requirements: Grounded electrical convenience outlets, air conditioned and heated.
- Window to outside. Windows to be fixed.
- Floor Finishes: Resilient flooring with non-drained recess floor matt.
- Wall Finishes: Painted gypsum board.
- Ceiling Finishes: Acoustical ceiling.
- Lighting: Office Light Fixture. Refer to Chapter 4 for foot candle and fixture requirements.



## LOBBY

(ADMINISTRATION)

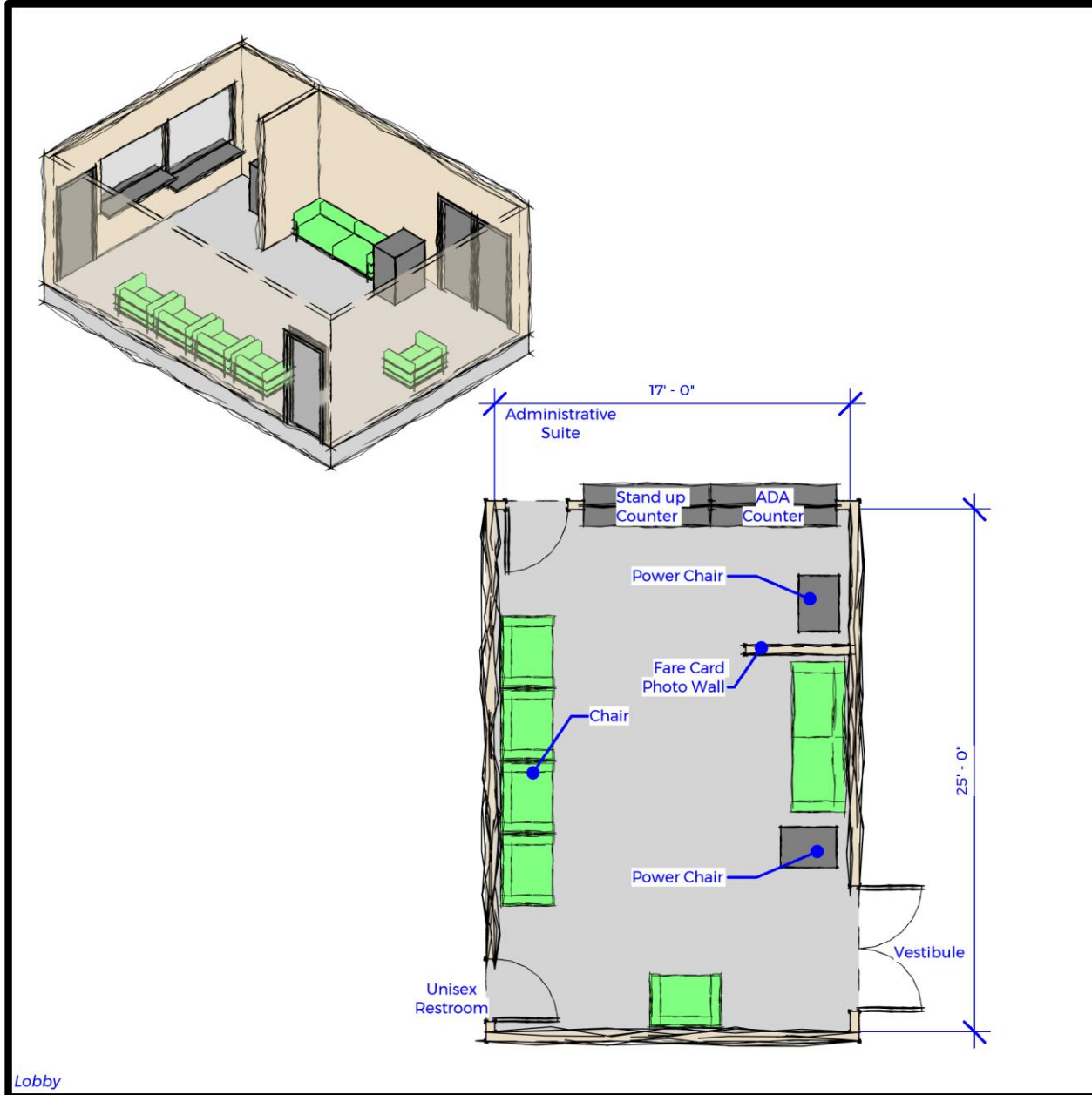

### Function

- Administration lobby area with seating for up to 8 people and floor space to accommodate 2 power chairs.

### Relationship to other Areas

- Adjacent to Administration Counter.
- Adjacent to Vestibule.
- Adjacent to Small Conference Room.
- Adjacent to Unisex Restroom.

### Comments / Characteristics

- Furnishings: Refer to graphic on this page.
- Utility requirements: Grounded electrical convenience outlets, intercom/paging system, air conditioned and heated.
- Window to outside if possible. Windows to be fixed.
- Floor Finishes: Resilient flooring.
- Wall Finishes: Painted gypsum board and/or concrete block.
- Ceiling Finishes: Acoustical ceiling.
- Lighting: Office Light Fixture. Refer to Chapter 4 for foot candle and fixture requirements.
- Open split-level counter with rolling security screen for after hours securement.

## UNISEX RESTROOM

(ADMINISTRATION)

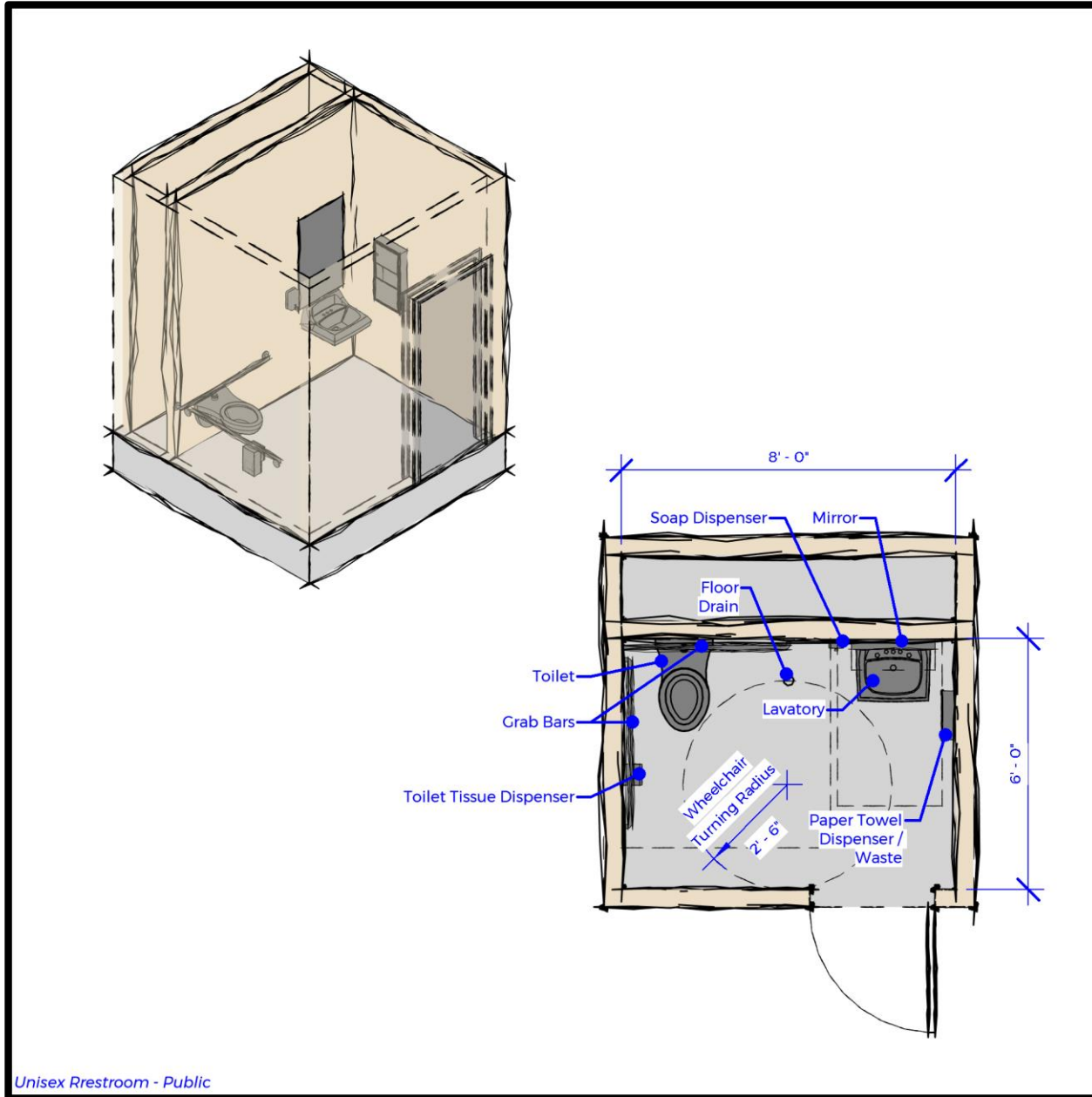

Unisex Restroom - Public

### Function

- Unisex restroom facilities for Administration visitors.

### Relationship to other Areas

- Adjacent to Lobby.

### Comments / Characteristics

- Furnishings: Refer to graphic on this page.
- Utility requirements: Grounded electrical convenience outlets, intercom/paging system, air conditioned, ventilated, and heated.
- Floor Finishes: Porcelain tile.
- Wall Finishes: Porcelain tile on all wet walls and 60 inches minimum above finish floor to sides of toilet and lavatory. Paint or porcelain tile on gypsum board all other wall surfaces.
- Ceiling Finishes: Paint gypsum board.
- Lighting: Wet location sealed fixtures and indirect light over mirror. Refer to Chapter 4 for foot candle and fixture requirements.

### Transit Manager

See Typical Module 2

*(Administration)*

#### FUNCTION

- Enclosed private office for the Transit Manager.

#### RELATIONSHIP TO OTHER AREAS

- Adjacent to Assistant Transit Manager.
- Near Counter.

#### COMMENTS / CHARACTERISTICS

- Furnishings: Refer to module graphic.
- Utility Requirements: Grounded electrical convenience outlets, telephone, intercom/paging system, conduit for network computer system, air conditioned, and heated.
- Window to outside. Windows to be operable.
- Floor Finishes: Carpet.
- Wall Finishes: Painted gypsum board.
- Ceiling Finishes: Acoustical tile ceiling.
- Lighting: Office Light Fixture. Refer to Chapter 4 for foot candle and fixture requirements.
- Acoustically separated from surround spaces.
- 

### Assistant Transit Manager

See Typical See Typical Module 1

*(Administration)*

#### FUNCTION

- Enclosed private office for the Assistant Transit Manager.

#### RELATIONSHIP TO OTHER AREAS

- Adjacent to Transit Manager.

#### COMMENTS / CHARACTERISTICS

- Furnishings: Refer to module graphic.
- Utility Requirements: Grounded electrical convenience outlets, telephone, intercom/paging system, conduit for network computer system, air conditioned, and heated.
- Window to outside. Windows to be operable.
- Floor Finishes: Carpet.
- Wall Finishes: Painted gypsum board.
- Ceiling Finishes: Acoustical tile ceiling.
- Lighting: Office Light Fixture. Refer to Chapter 4 for foot candle and fixture requirements.
- Acoustically separated from surround spaces.

## Planning Program Manager

See Typical Module 1

*(Administration)*

### FUNCTION

- Enclosed private office for the Planning Program Manager.

### RELATIONSHIP TO OTHER AREAS

- Adjacent to...
- Near Program Manager and Program Analysts

### COMMENTS / CHARACTERISTICS

- Furnishings: Refer to module graphic.
- Utility Requirements: Grounded electrical convenience outlets, telephone, intercom/paging system, conduit for network computer system, air conditioned, and heated.
- Window to outside if possible. Windows to be operable.
- Floor Finishes: Carpet.
- Wall Finishes: Painted gypsum board.
- Ceiling Finishes: Acoustical tile ceiling.
- Lighting: Office Light Fixture. Refer to Chapter 4 for foot candle and fixture requirements.
- Acoustically separated from surround spaces.

## Finance Program Manager

See Typical Module 2

*(Administration)*

### FUNCTION

- Enclosed private office for the Finance Program Manager.

### RELATIONSHIP TO OTHER AREAS

- Adjacent to...
- Near Transit Manager

### COMMENTS / CHARACTERISTICS

- Furnishings: Refer to module graphic.
- Utility Requirements: Grounded electrical convenience outlets, telephone, intercom/paging system, conduit for network computer system, air conditioned, and heated.
- Window to outside if possible. Windows to be operable.
- Floor Finishes: Carpet.
- Wall Finishes: Painted gypsum board.
- Ceiling Finishes: Acoustical tile ceiling.
- Lighting: Office Light Fixture. Refer to Chapter 4 for foot candle and fixture requirements.
- Acoustically separated from surround spaces.

## ADMINISTRATIVE SUITE

(ADMINISTRATION)

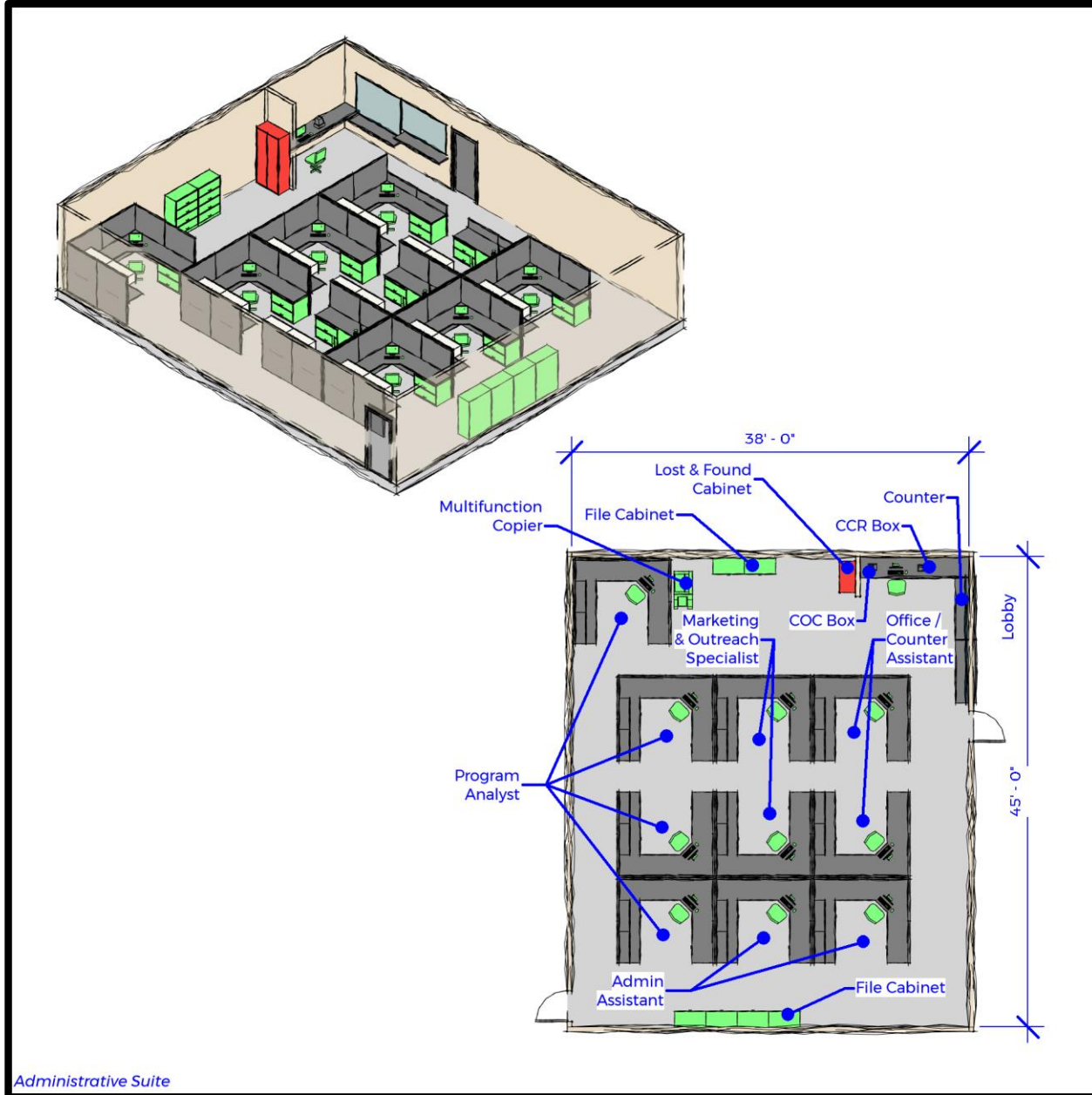

Administrative Suite

### Function

- Enclosed suite to house Public Service Counter, Program Analyst, Administrative Assistants, Office / Counter Assistant, and Marketing and Outreach Specialist workstations and shared administrative files.

### Relationship to other Areas

- Adjacent to Lobby.
- Near Transit, Planning Program and Finance Managers.

### Comments / Characteristics

- Furnishings: Refer to graphic on this page
- Utility Requirements: Grounded electrical convenience outlets, J-boxes in wall behind workstations with power and data to allow connections for powered workstations, utility whips, data connections for printer, air conditioned, and heated.
- Electrical power at counter for cash drawer, credit card reader (CR), connect card ID card printer (COC), and
- Floor Finishes: Carpet
- Wall Finishes: Painted gypsum board.
- Ceiling Finishes: Acoustical tile ceiling.
- Lighting: Office Light Fixture. Refer to Chapter 4 for foot candle and fixture requirements.

## Counter

(Administration)

### FUNCTION

- Counter area for public to take photos for new fare cards, apply for paratransit services, and general interaction with Administrative staff.

### RELATIONSHIP TO OTHER AREAS

- Adjacent to Lobby.
- Near Office / Counter Assistant.

### COMMENTS / CHARACTERISTICS

- Furnishings: Refer to graphic on previous page.
- Utility Requirements: Grounded electrical convenience outlets, telephone, intercom/paging system, conduit for network computer system, dedicated data connection for credit card reader (CR), air conditioned, and heated.
- Electrical power at counter for cash drawer, credit card reader (CR), and connect card ID card printer (COC).
- Floor Finishes: Carpet.
- Wall Finishes: Painted Gypsum board.
- Ceiling Finishes: Acoustical tile ceiling.
- Lighting: Office Light Fixture. Refer to Chapter 4 for foot candle and fixture requirements.

## Program Analyst

(Administration)

See Typical Workstation 2B

### FUNCTION

- Open workspace for the Program Analyst.

### RELATIONSHIP TO OTHER AREAS

- Adjacent to Administrative Assistant.
- Near Planning Program Manager and Program Manager

### COMMENTS / CHARACTERISTICS

- Furnishings: Refer to workstation graphic and graphic on Page 3.11.
- Utility Requirements: Grounded electrical convenience outlets, telephone, intercom/paging system, conduit for network computer system, air conditioned, and heated.
- Floor Finishes: Carpet.
- Wall Finishes: Painted Gypsum board.
- Ceiling Finishes: Acoustical ceiling.
- Lighting: Office Light Fixture. Refer to Chapter 4 for foot candle and fixture requirements.
- Define space with 66" high modular office partitions.

### Administrative Assistant

See Typical Workstation 2B

*(Administration)*

#### FUNCTION

- Open workspace for the Administrative Assistant.

#### RELATIONSHIP TO OTHER AREAS

- Adjacent to Program Analyst.
- Close by Administrative Managers

#### COMMENTS / CHARACTERISTICS

- Furnishings: Refer to workstation graphic and graphic on Page 3.11.
- Utility Requirements: Grounded electrical convenience outlets, telephone, intercom/paging system, conduit for network computer system, air conditioned, and heated.
- Floor Finishes: Carpet.
- Wall Finishes: Painted Gypsum board.
- Ceiling Finishes: Acoustical ceiling.
- Lighting: Office Light Fixture. Refer to Chapter 4 for foot candle and fixture requirements.
- Define space with 66" high modular office partitions.

### Office / Counter Assistant

See Typical Workstation 2A

*(Administration)*

#### FUNCTION

- Open workspace for the Office / Counter Assistant.

#### RELATIONSHIP TO OTHER AREAS

- Adjacent to the Lobby and Counter
- Near the Transit Manager.

#### COMMENTS / CHARACTERISTICS

- Furnishings: Refer to workstation graphic and graphic on Page 3.11.
- Utility Requirements: Grounded electrical convenience outlets, telephone, intercom/paging system, conduit for network computer system, air conditioned, and heated.
- Floor Finishes: Carpet.
- Wall Finishes: Painted Gypsum board.
- Ceiling Finishes: Acoustical tile ceiling.
- Lighting: Office Light Fixture. Refer to Chapter 4 for foot candle and fixture requirements.
- Define space with 66" high side and back modular office partitions and 42" high (low side) front modular office partition facing the counter to allow visual monitoring of the counter.

## Marketing and Outreach Specialist

See Typical Workstation 2B

*(Administration)*

### FUNCTION

- Open workspace for the Marketing and Outreach Specialist.

### RELATIONSHIP TO OTHER AREAS

- Convenient access to managers and Copy / Work Room

### COMMENTS / CHARACTERISTICS

- Furnishings: Refer to workstation graphic and graphic on Page 3.11.
- Utility Requirements: Grounded electrical convenience outlets, telephone, intercom/paging system, conduit for network computer system, air conditioned, and heated.
- Floor Finishes: Carpet.
- Wall Finishes: Painted Gypsum board.
- Ceiling Finishes: Acoustical tile ceiling.
- Lighting: Office Light Fixture. Refer to Chapter 4 for foot candle and fixture requirements.
- Define space with 66" high modular office partitions.

## Current Files

*(Administration)*

### FUNCTION

- Open area within the Administrative Suite for file cabinets.

### RELATIONSHIP TO OTHER AREAS

- Near Administrative office and workstations.

### COMMENTS / CHARACTERISTICS

- Furnishings: Refer to graphic on page. 3.11. Six lockable four drawer lateral file cabinets.
- Utility Requirements: Air conditioned and heated.
- Floor Finishes: Carpet.
- Wall Finishes: Painted gypsum board.
- Ceiling Finishes: Acoustical tile ceiling.
- Lighting: Office Light Fixture – common area. Refer to Chapter 4 for foot candle and fixture requirements.



## Lost and Found Cabinet

(Administration)

### FUNCTION

- Secure and lockable cabinet for lost and found items to be distributed at Counter to public in the Lobby.

### RELATIONSHIP TO OTHER AREAS

- Adjacent to Counter.
- Near Lobby.

### COMMENTS / CHARACTERISTICS

- Furnishings: Refer to graphic on page. 3.11. Lockable two door cabinet.
- Utility Requirements: None.
- Floor Finishes: None.
- Wall Finishes: None.
- Ceiling Finishes: None.
- Lighting: None.

## Program Manager (Undefined)

(Administration)

See Typical Module 1

### FUNCTION

- Enclosed private office for the Program Manager.

### RELATIONSHIP TO OTHER AREAS

- Adjacent to Planning Program Manager
- Near Transit Manager

### COMMENTS / CHARACTERISTICS

- Furnishings: Refer to module graphic.
- Utility Requirements: Grounded electrical convenience outlets, telephone, intercom/paging system, conduit for network computer system, air conditioned, and heated.
- Window to outside if possible. Windows to be operable.
- Floor Finishes: Carpet
- Wall Finishes: Painted gypsum board.
- Ceiling Finishes: Acoustical tile ceiling.
- Lighting: Office Light Fixture. Refer to Chapter 4 for foot candle and fixture requirements.

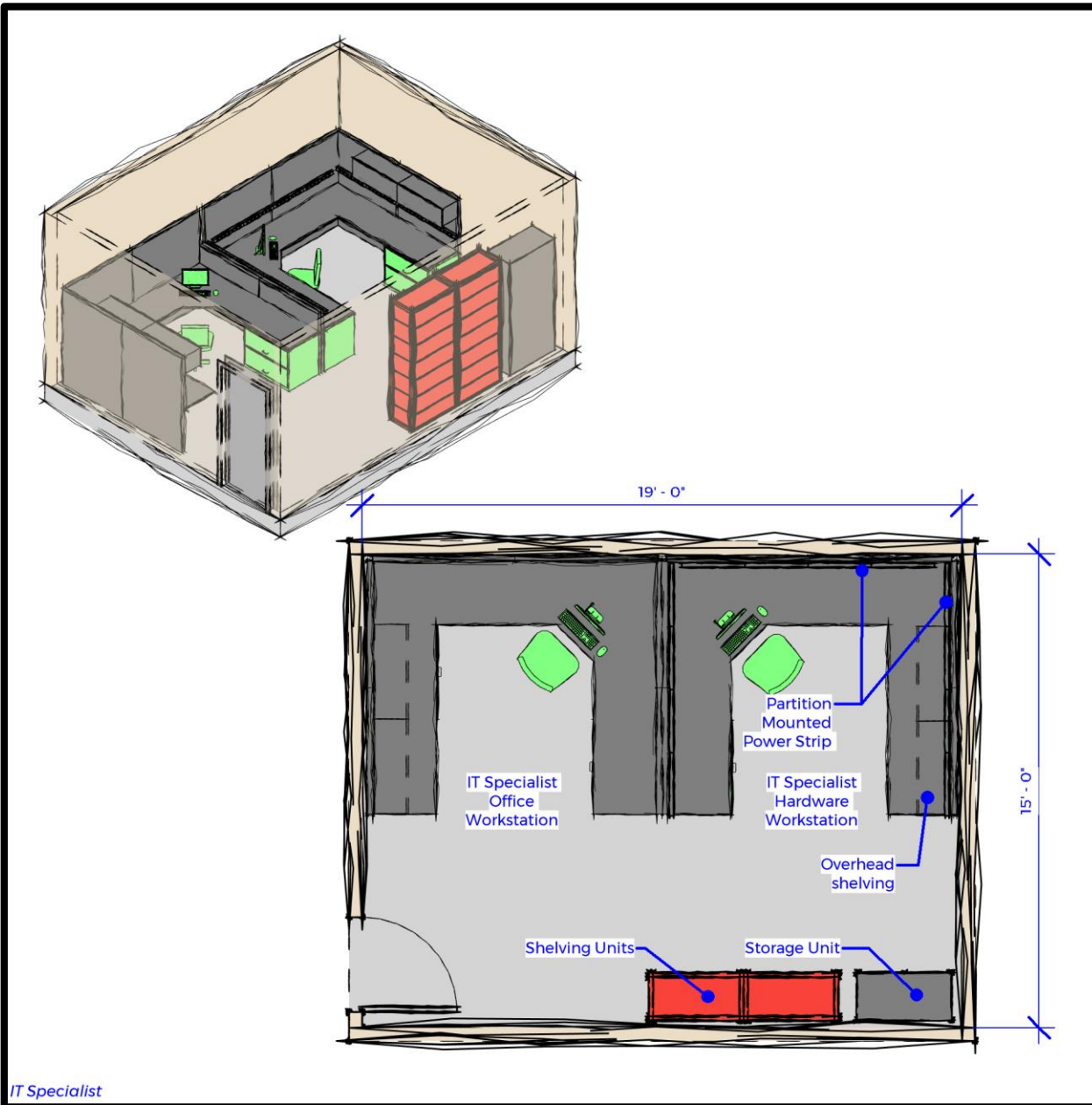

### See Typical Workstation 2A

#### Function

- Open workstation area for the IT Specialist.

#### Relationship to other Areas

- Located within the IT Specialist suite.
- Adjacent to Telephone / Server / AV Equipment Room.

#### Comments / Characteristics

- Furnishings: Refer to graphic on this page.
- Utility Requirements: Grounded electrical convenience outlets, telephone, intercom/paging system, conduit for network computer system, air conditioned, and heated.
- Additional continuous plug strip mounted at or above worksurface height at hardware workstation on all three workstation sides
- Floor Finishes: Static dissipative flooring.
- Painted gypsum board.
- Ceiling Finishes: Acoustical tile ceiling.
- Lighting: Office Light Fixture. Refer to Chapter 4 for foot candle and fixture requirements.
- Define space with 66" high modular office partitions.

## CONFERENCE ROOM – SMALL

(ADMINISTRATION)

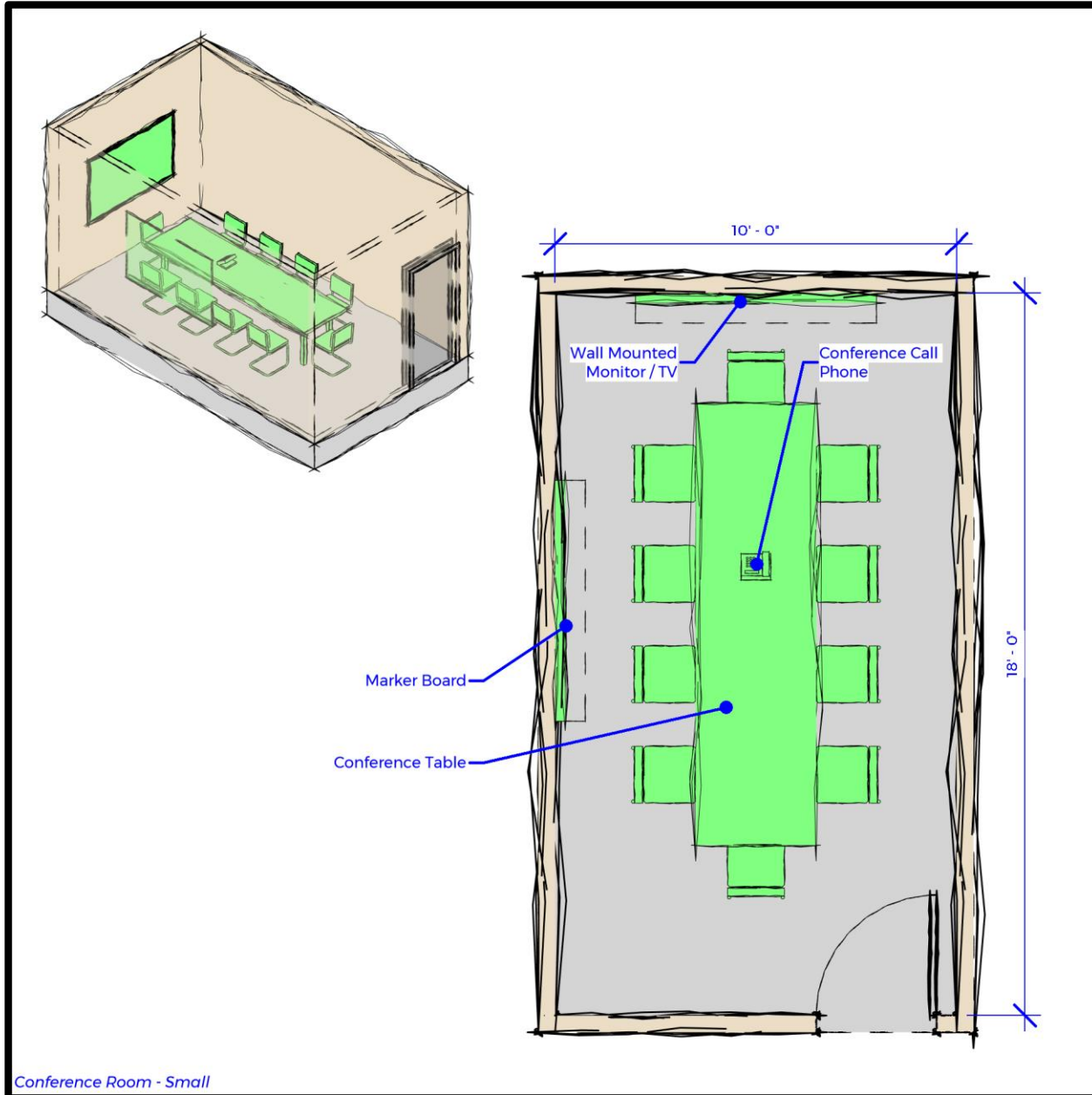

### Function

- Area for meetings for up to 10 people.

### Relationship to other Areas

- Adjacent to Lobby.
- Near Administrative Suite.

### Comments / Characteristics

- Furnishings: Refer to graphic on this page.
- Utility Requirements: Grounded electrical convenience outlets, telephone, intercom/paging system, conduit for network computer system tied from ceiling projection to wall below television to floor box below table to allow laptop on table to connect, air conditioned, and heated.
- Window to outside if possible. Windows to be operable with black out shade.
- Floor Finishes: Resilient flooring.
- Wall Finishes: Painted gypsum board.
- Ceiling Finishes: Acoustical tile ceiling.
- Lighting: Office Light Fixture Dimmable. Refer to Chapter 4 for foot candle and fixture requirements. and dimmable downlights to either/both television or projection screen. Lighting design shall have ability to dim the front area near projection screen.
- Acoustically separated from surrounding spaces.

COPY / WORK ROOM

(ADMINISTRATION)

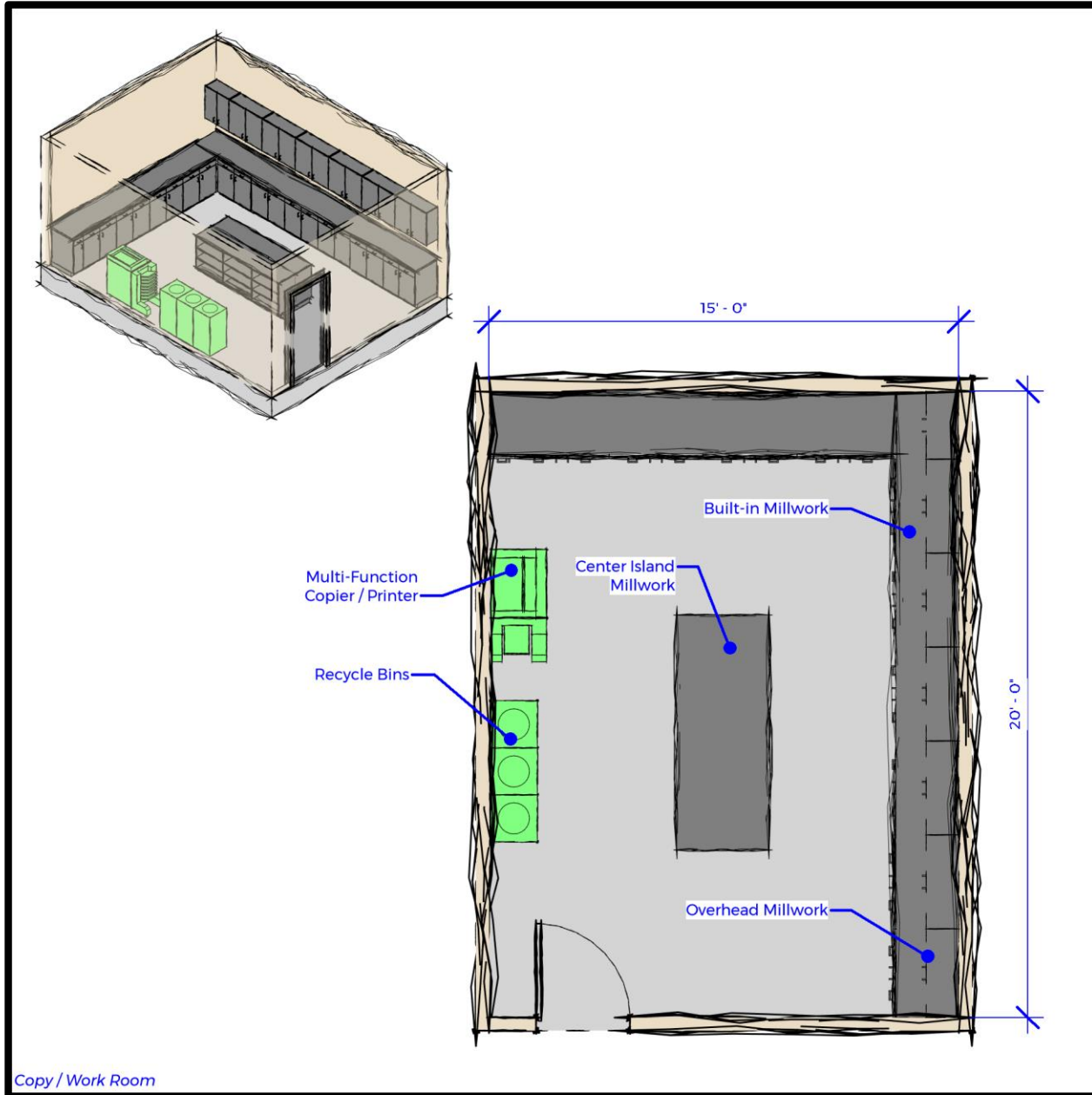

**Function**

- Designated area for multi-function copier/scanner/printer, cutting board, supply storage, and work surfaces.

**Relationship to other Areas**

- Centrally located within office.

**Comments / Characteristics**

- Furnishings: Refer to graphic on this page.
- Utility Requirements: Grounded electrical convenience outlets, telephone, intercom/paging system, conduit for network computer system, air conditioned, and heated.
- Floor Finishes: Resilient flooring.
- Wall Finishes: Painted gypsum board.
- Ceiling Finishes: Acoustical tile ceiling.
- Lighting: Office Light Fixture. Refer to Chapter 4 for foot candle and fixture requirements.

## STORAGE ROOM

(ADMINISTRATION)

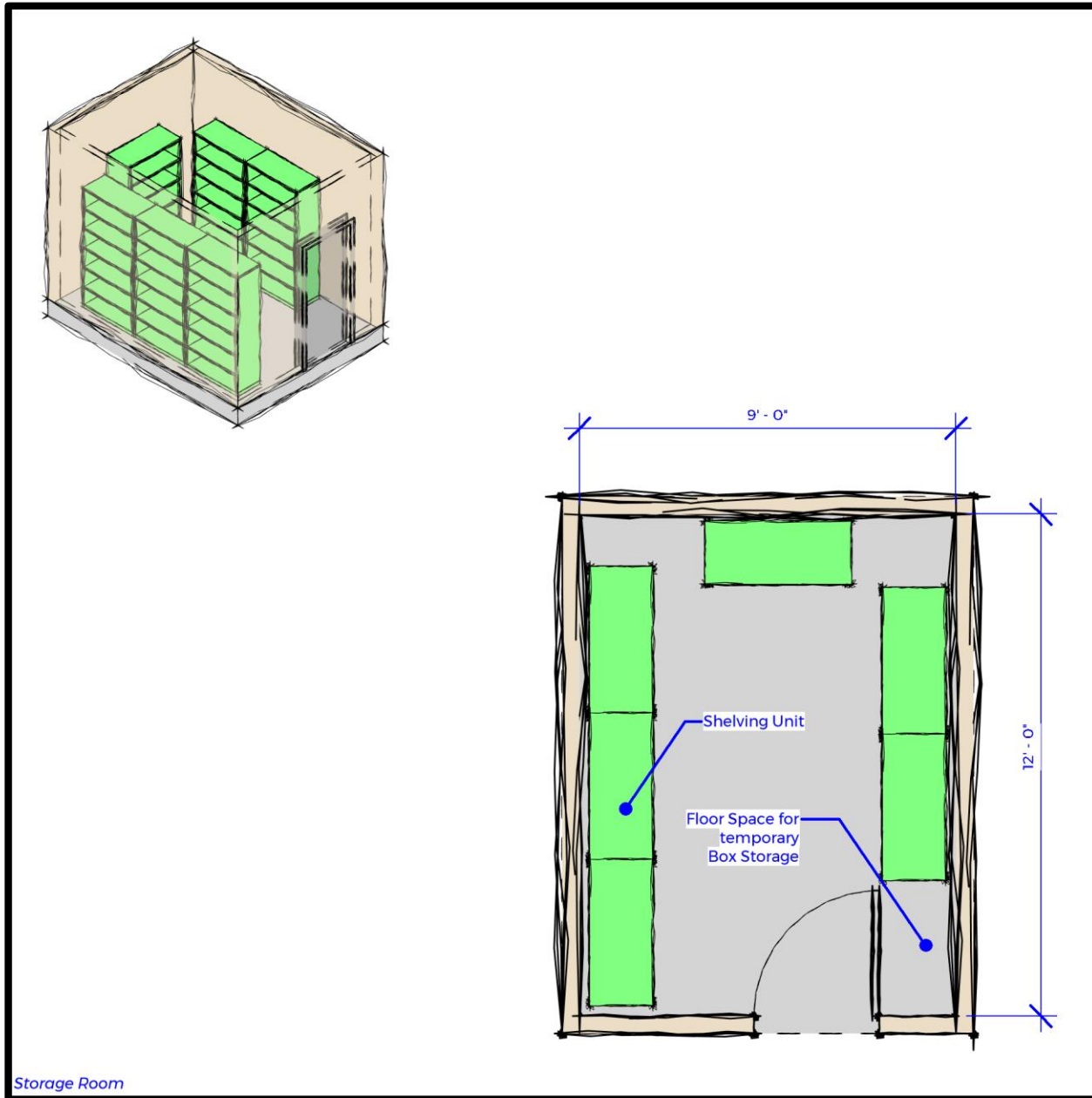

### Function

- Enclosed area for files and other sensitive materials stored on shelves.

### Relationship to other Areas

- Adjacent to Administrative Suite.

### Comments / Characteristics

- Furnishings: Refer to graphic on this page. Six shelving units to accommodate up to 21 storage boxes per shelving unit for up to 126 file storage boxes total.
- Utility Requirements: Grounded electrical convenience outlet near door, air conditioned, and heated.
- Floor Finishes: Resilient flooring.
- Wall Finishes: Painted gypsum board.
- Ceiling Finishes: Acoustical tile ceiling.
- Lighting: Service Light Fixture – Storage rooms. Refer to Chapter 4 for foot candle and fixture requirements.



## ARCHIVE FILE STORAGE

(ADMINISTRATION)

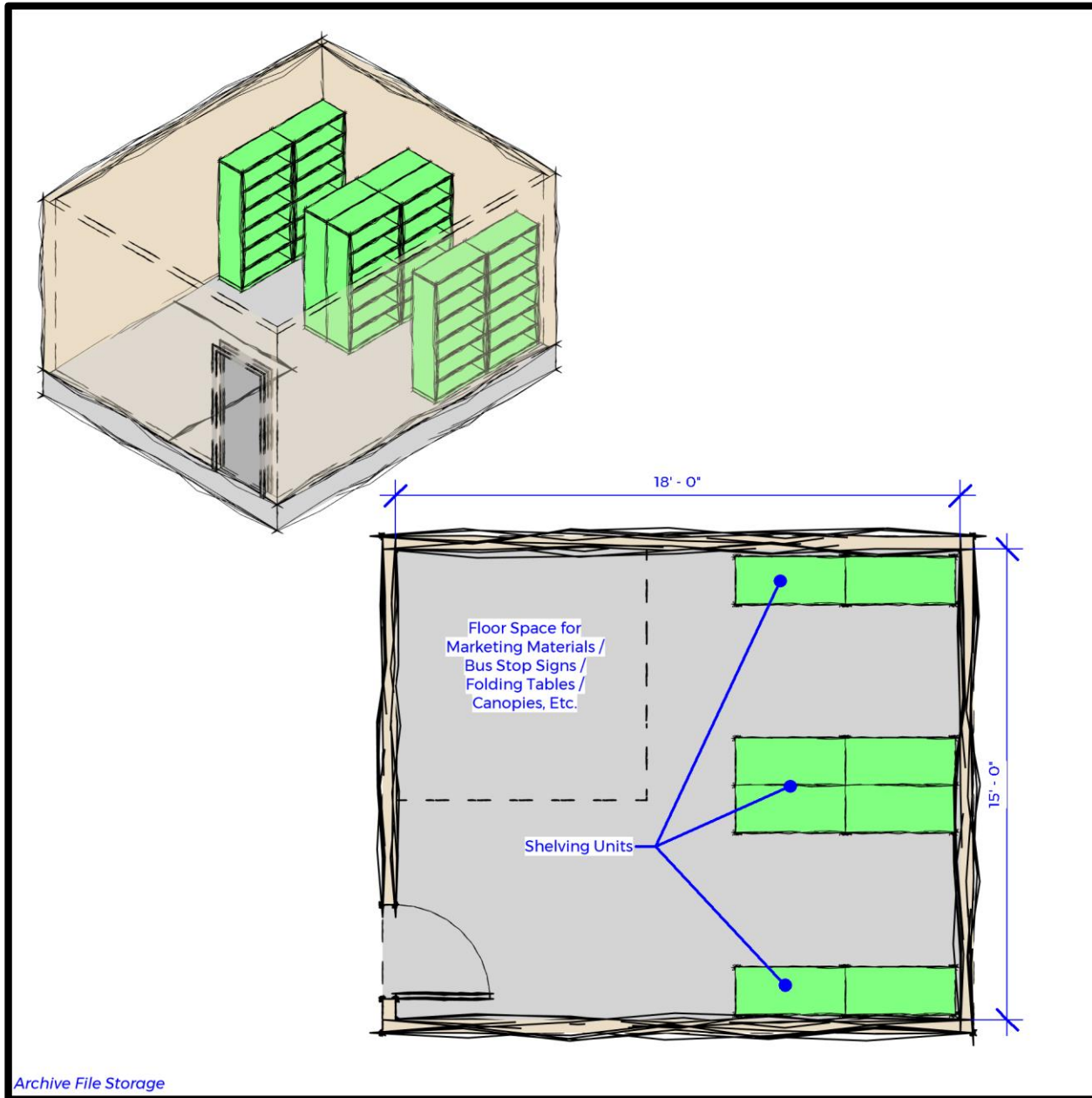

Archive File Storage

### Function

- Enclosed area for storage of record files and storage of marketing materials, bus stop signs, folding tables, pop-up canopies and other special occasion materials.

### Relationship to other Areas

- Adjacent to Administrative Suite.

### Comments / Characteristics

- Furnishings: Refer to graphic on this page. Eight shelving units to accommodate up to 21 storage boxes per shelving unit for up to 168 file storage boxes total.
- Utility Requirements: Grounded electrical convenience outlet near door, air conditioned, and heated.
- Floor Finishes: Resilient flooring.
- Wall Finishes: Painted gypsum board.
- Ceiling Finishes: Acoustical tile ceiling.
- Lighting: Service Light Fixture – Common area. Refer to Chapter 4 for foot candle and fixture requirements.

## BREAK ROOM

(ADMINISTRATION)

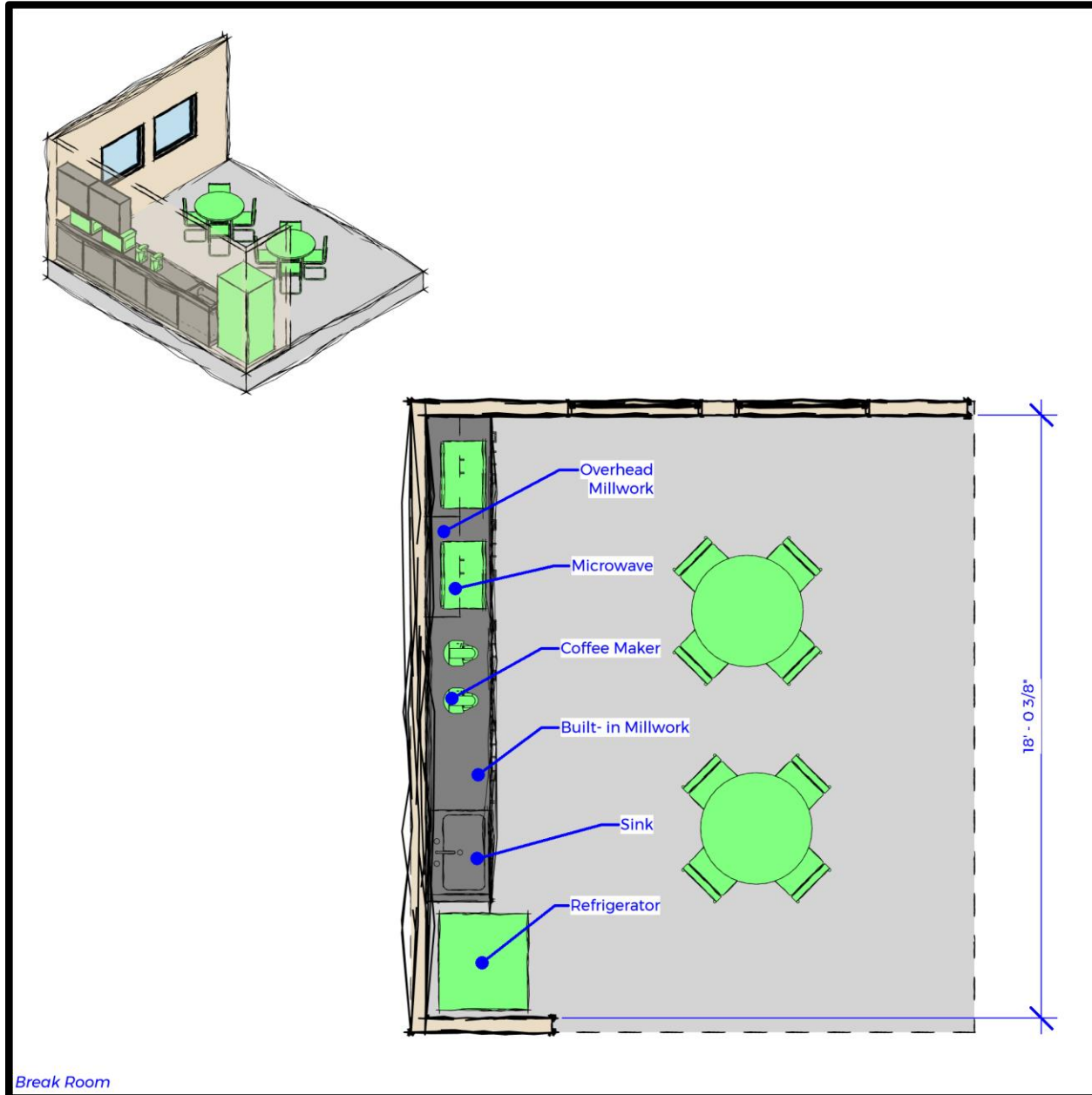

### Function

- Open area for Administrative personnel breaks.

### Relationship to other Areas

- Adjacent to Administrative Suite.

### Comments / Characteristics

- Furnishings: Refer to graphic on this page.
- Utility Requirements: Grounded electrical convenience outlets, telephone, intercom/paging system, air conditioned, and heated. Dedicated water line to ice maker in refrigerator and to coffee makers. Dedicated isolated outlet to each microwave. Provide above counter back splash electrical outlets
- Window to outside.
- Floor Finishes: Resilient flooring.
- Wall Finishes: Painted gypsum board.
- Ceiling Finishes: Acoustical tile ceiling.
- Lighting: Office Light Fixture - Common area. Refer to Chapter 4 for foot candle and fixture requirements.

## QUIET ROOM

(ADMINISTRATION)

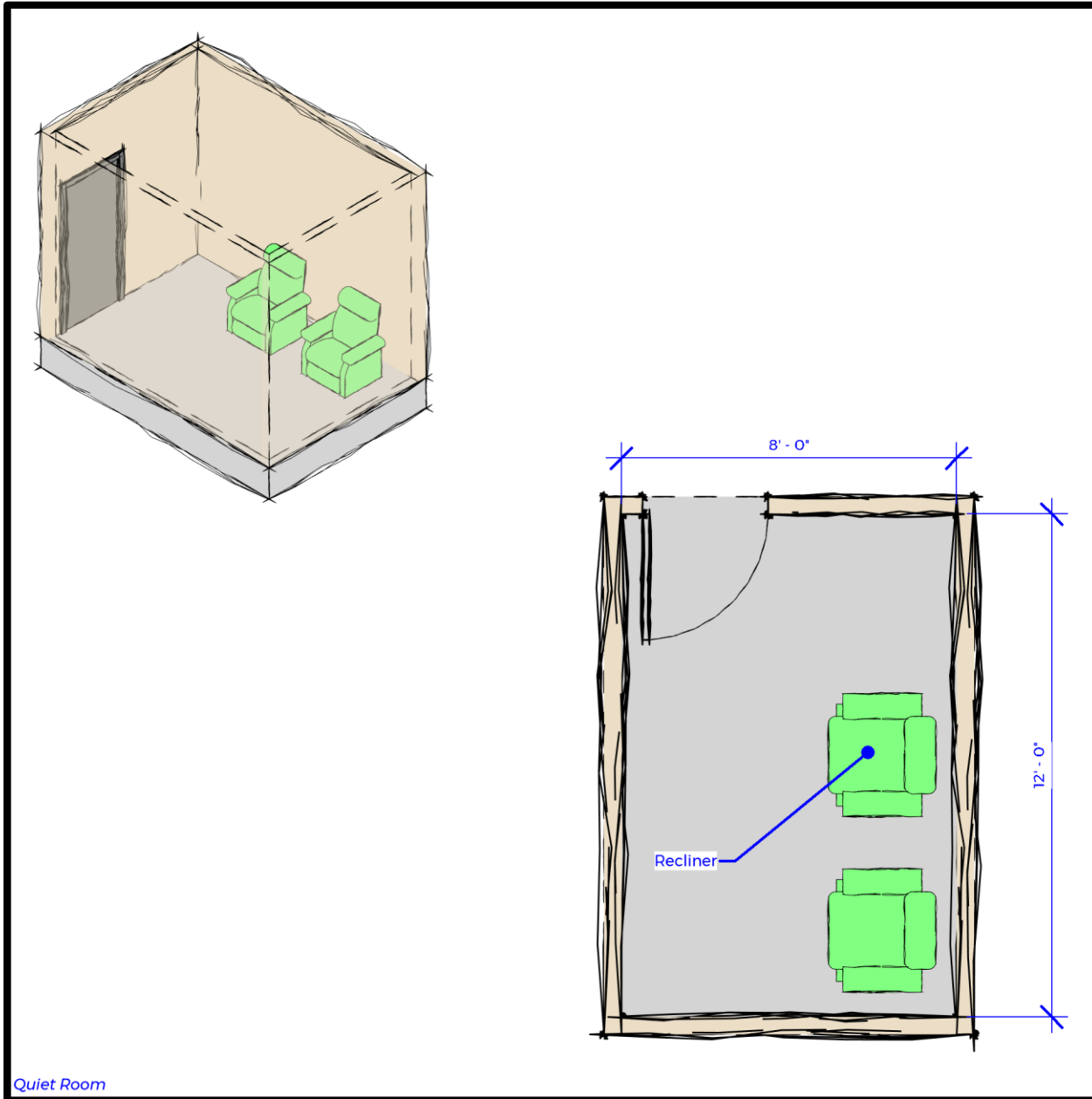

Quiet Room

### Function

- Enclosed area for Administrative use, between, and after shifts.

### Relationship to other Areas

- Adjacent to Administrative Suite.

### Comments / Characteristics

- Furnishings: Refer to graphic on this page.
- Utility Requirements: Grounded electrical convenience outlets, telephone, air conditioned, and heated.
- Floor Finishes: Carpet Tile.
- Wall Finishes: Painted gypsum board.
- Ceiling Finishes: Acoustical tile ceiling.
- Lighting: Office Light Fixture and dimmable down lights. Lighting design shall have the ability to dim. Refer to Chapter 4 for foot candle and fixture requirements. Task lighting provided at each recliner for reading without disturbing people in adjacent recliners. Provide floor lighting to keep light levels down.
- Acoustically isolated from surrounding spaces.
- Door to have narrow lite for visibility inside room from exterior.



## UNISEX RESTROOM

(ADMINISTRATION)

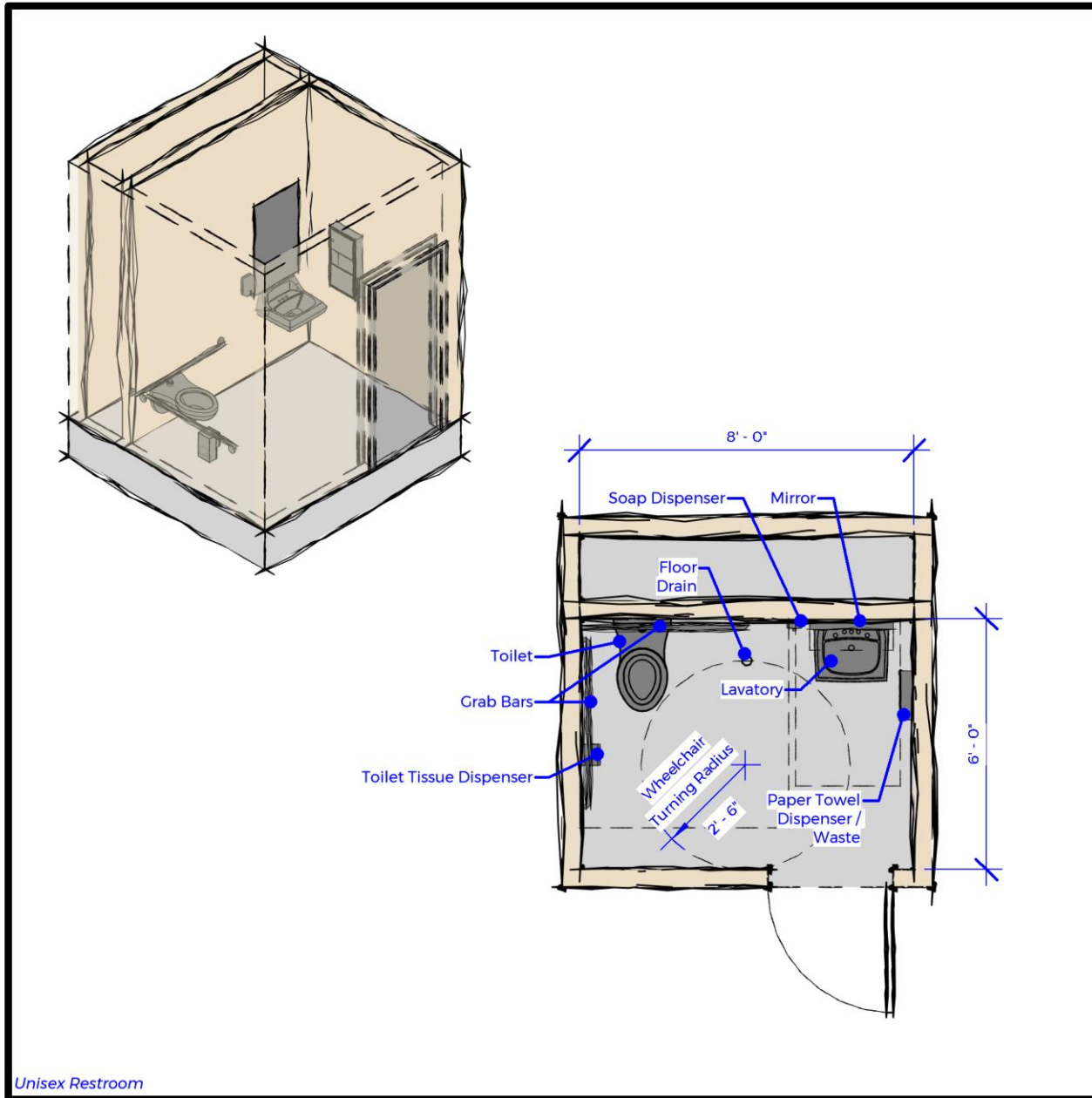

Unisex Restroom

### Function

- Unisex restroom facilities for Administration staff.

### Relationship to other Areas

- Adjacent to Administrative Suite.

### Comments / Characteristics

- Furnishings: Refer to graphic on this page.
- Utility requirements: Grounded electrical convenience outlets, intercom/paging system, air conditioned, ventilated, and heated.
- Floor Finishes: Porcelain tile.
- Wall Finishes: Porcelain tile on all wet walls and 60 inches minimum above finish floor to sides of toilet and lavatory. Paint or porcelain tile on gypsum board all other wall surfaces.
- Ceiling Finishes: Paint gypsum board.
- Lighting: Wet location sealed fixtures and indirect light over mirror. Refer to Chapter 4 for foot candle and fixture requirements.

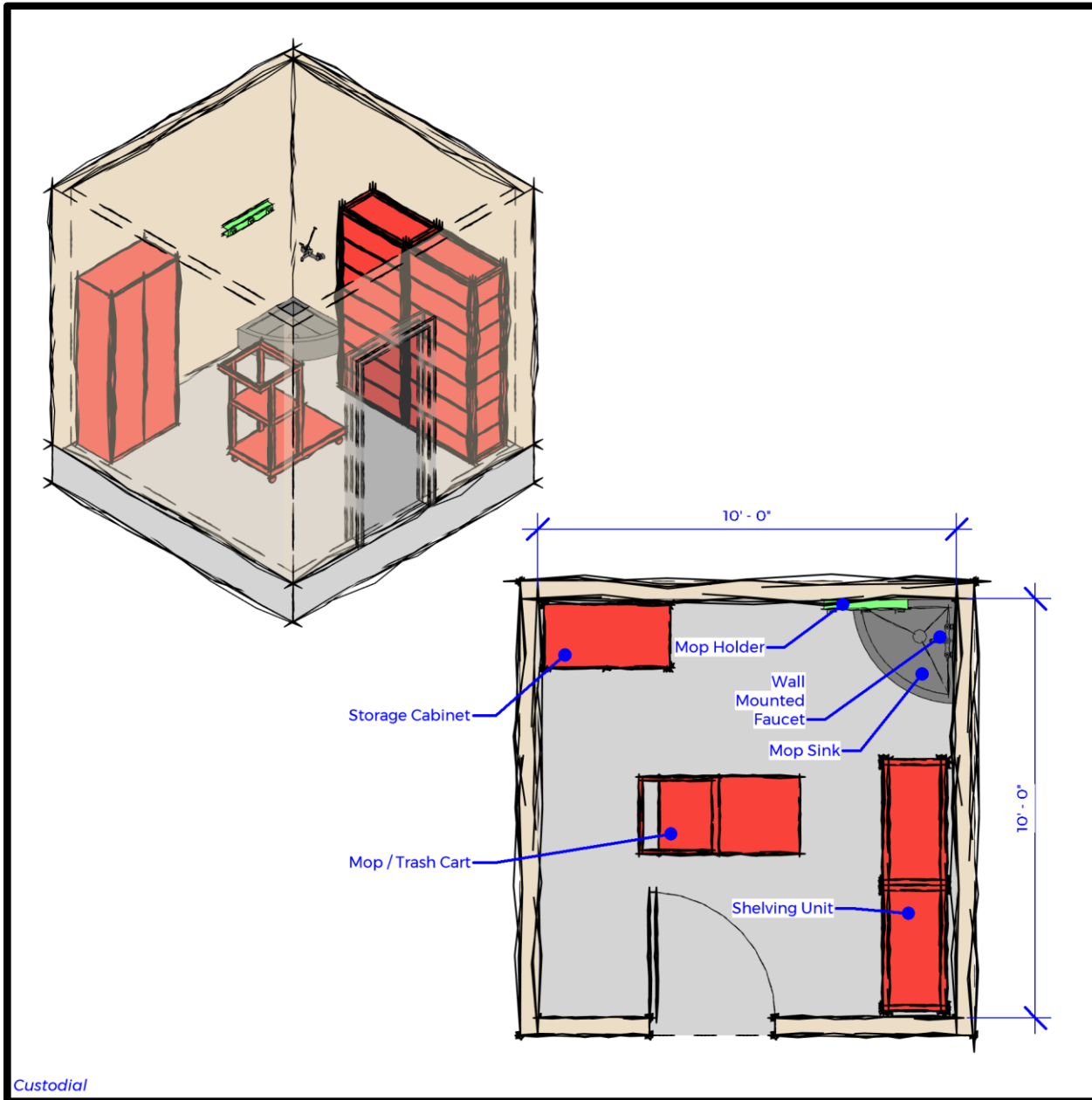

**Function**

- Enclosed area for storage of janitorial and cleaning supplies.

**Relationship to other Areas**

- Located conveniently within Administrative area.

**Comments / Characteristics**

- Furnishings: Refer to graphic on this page.
- Floor mounted mop sink with wall mounted faucet with bucket hook.
- Utility Requirements: Grounded electrical convenience outlets, ventilated, and heated.
- Floor Finishes: Porcelain tile or sealed concrete.
- Wall Finishes: Porcelain tile on gypsum board and/or concrete block.
- Ceiling Finishes: Acoustical ceiling where appropriate.
- Lighting: Service Light Fixture – Utility spaces. Refer to Chapter 4 for foot candle and fixture requirements.

Custodial

TELEPHONE / SERVER / AV EQUIP ROOM

(ADMINISTRATION)

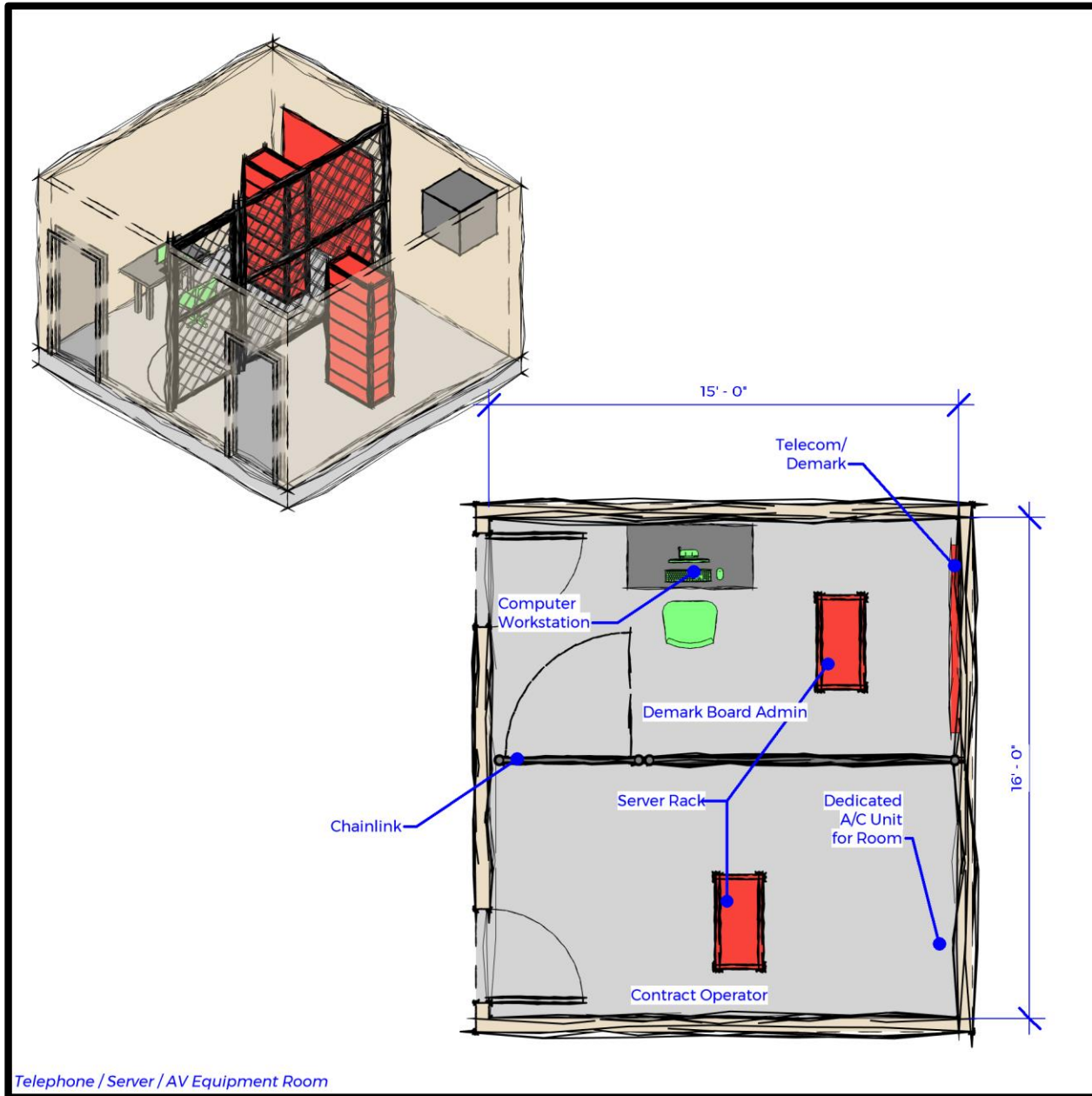

Telephone / Server / AV Equipment Room

**Function**

- Enclosed separately secured area for telephone, computer server, and AV equipment.

**Relationship to other Areas**

- Adjacent to IT Specialist Suite.

**Comments / Characteristics**

- Furnishings: Refer to graphic on this page. Include a UPS in the room.
- Utility Requirements: Grounded electrical convenience outlets, conduit for network computer system, air conditioned, and heated. Provide dedicated air conditioning unit for cooling temperature of IT equipment.
- Floor Finishes: Static dissipative flooring.
- Wall Finishes: Painted gypsum board.
- Ceiling Finishes: Painted exposed structure
- Lighting: Service Light Fixture - Shop. Refer to Chapter 4 for foot candle and fixture requirements.

**THIS PAGE INTENTIONALLY LEFT BLANK**

## OPERATIONS

### FUNCTIONAL RELATIONSHIP DIAGRAM

The relationships between the spaces within this section are shown below. The design should accommodate these relationships in order to maximize operational efficiency. This diagram is not meant to be a floor plan. It serves only as a representational relationship diagram.

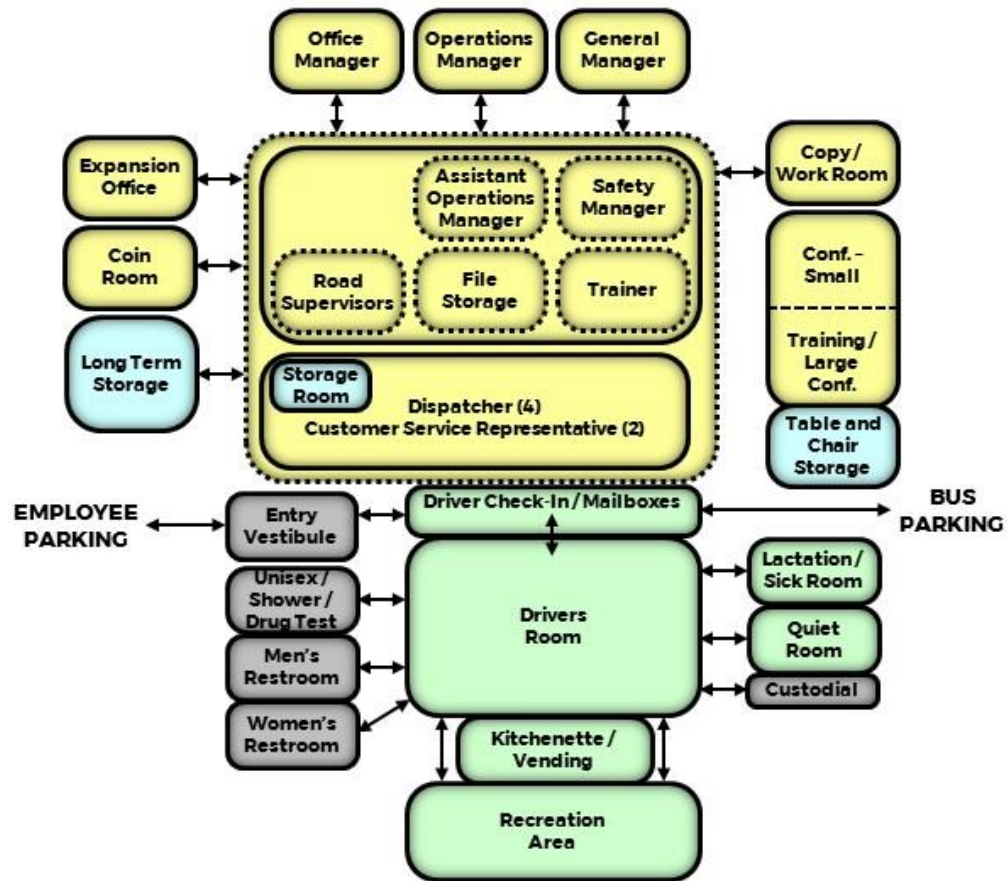

### FUNCTIONAL AREA MODULES

Each functional area within this section has been individually defined as a module. Each module has information regarding the function of the space, relationships to other areas and other information received during interviews with Yuba-Sutter Transit staff.

## General Manager

See Typical Module 3

### FUNCTION

- Enclosed private office for the General Manager.

### RELATIONSHIP TO OTHER AREAS

- Adjacent to Operations Manager.
- Adjacent to Operations Suite.
- Near Dispatch Suite.

### COMMENTS / CHARACTERISTICS

- Furnishings: Refer to module graphic.
- Utility Requirements: Grounded electrical convenience outlets, telephone, intercom/paging system, conduit for network computer system, air conditioned, and heated.
- Window to outside. Windows to be operable.
- Floor Finishes: Carpet
- Wall Finishes: Painted gypsum board.
- Ceiling Finishes: Acoustical tile ceiling.
- Lighting: Office Light Fixture. Refer to Chapter 4 for foot candle and fixture requirements.
- Acoustically separated from surround spaces.

## (Operations)

## Operations Manager

See Typical Module 1

### FUNCTION

- Enclosed private office for the Operations Manager.

### RELATIONSHIP TO OTHER AREAS

- Adjacent to General Manager.
- Adjacent to Operations Suite.
- Near Dispatch Suite.

### COMMENTS / CHARACTERISTICS

- Furnishings: Refer to module graphic.
- Utility Requirements: Grounded electrical convenience outlets, telephone, intercom/paging system, conduit for network computer system, air conditioned, and heated.
- Window to outside. Windows to be operable.
- Floor Finishes: Carpet
- Wall Finishes: Painted gypsum board.
- Ceiling Finishes: Acoustical tile ceiling.
- Lighting: Office Light Fixture. Refer to Chapter 4 for foot candle and fixture requirements.
- Acoustically separated from surround spaces.

## (Operations)

## Office Manager

See Typical Module 1

*(Operations)*

### FUNCTION

- Enclosed private office for the Office Manager.

### RELATIONSHIP TO OTHER AREAS

- Adjacent to Operations Manager.
- Adjacent to Operations Suite.
- Near Dispatch Suite.

### COMMENTS / CHARACTERISTICS

- Furnishings: Refer to module graphic.
- Utility Requirements: Grounded electrical convenience outlets, telephone, intercom/paging system, conduit for network computer system, air conditioned, and heated.
- Window to outside. Windows to be operable.
- Floor Finishes: Carpet
- Wall Finishes: Painted gypsum board.
- Ceiling Finishes: Acoustical tile ceiling.
- Lighting: Office Light Fixture. Refer to Chapter 4 for foot candle and fixture requirements.
- Acoustically separated from surround spaces.



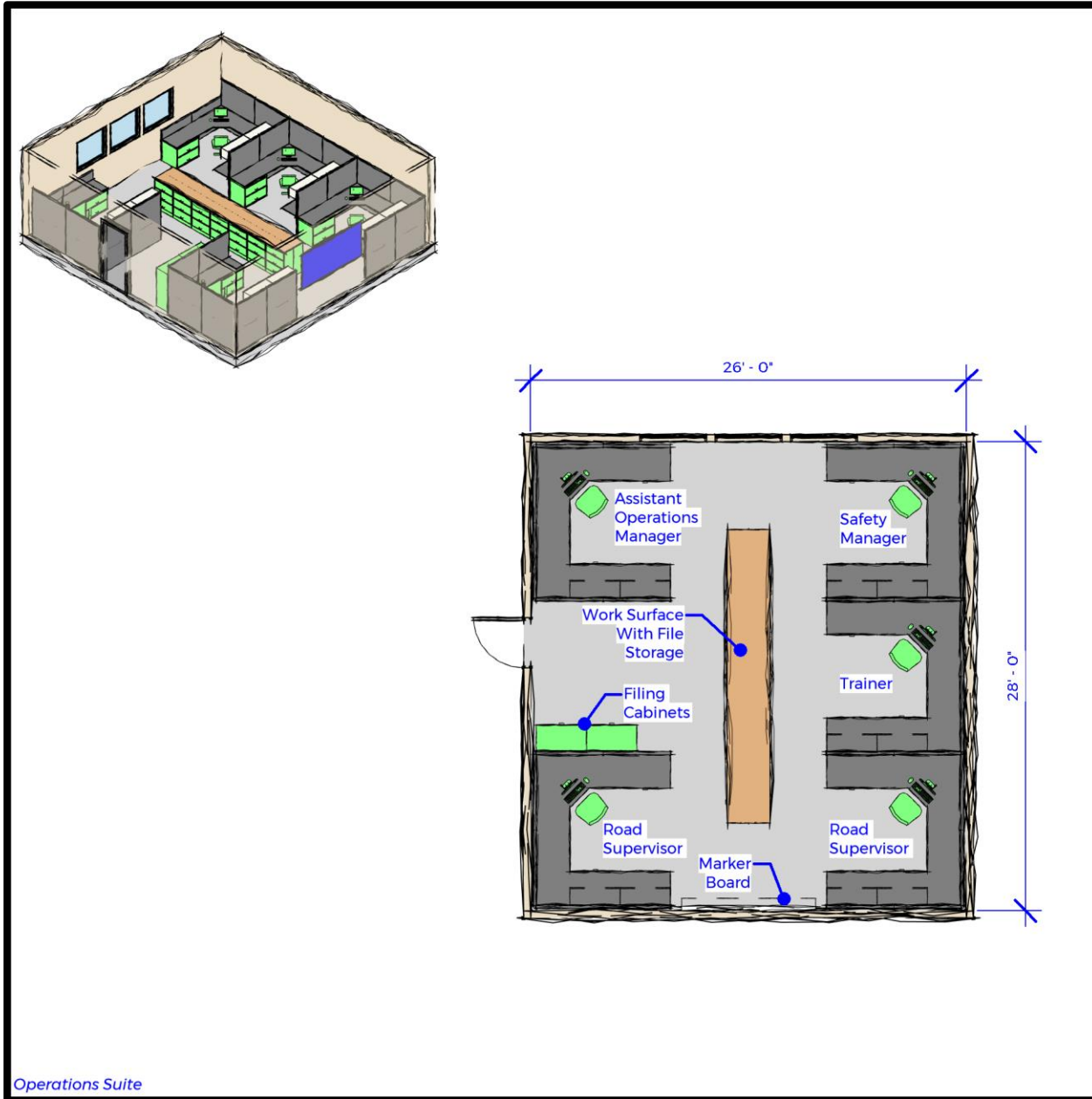

See Typical Workstation 2B

Function

- Enclosed office suite for the Assistant Operations Manager, Safety Manager, Trainer, and Road Supervisors' workstations and shared Operations file storage.

Relationship to other Areas

- Adjacent to Drivers Room.
- Near Dispatch Suite.

Comments / Characteristics

- Furnishings: Refer to workstation graphic and graphic on this page.
- Utility Requirements: Grounded electrical convenience outlets, telephone, intercom/paging system, conduit for network computer system, air conditioned, and heated.
- Floor Finishes: Carpet.
- Wall Finishes: Painted Gypsum board.
- Ceiling Finishes: Acoustical tile ceiling.
- Lighting: Office Light Fixture. Refer to Chapter 4 for foot candle and fixture requirements.



### Assistant Operations Manager

See Typical Workstation 2B

#### FUNCTION

- Open workspace for the Assistant Operations Manager.

#### RELATIONSHIP TO OTHER AREAS

- Adjacent to Drivers Room.
- Near Dispatch Suite.

#### COMMENTS / CHARACTERISTICS

- Furnishings: Refer to workstation graphic and graphic on Page 3.30.
- Utility Requirements: Grounded electrical convenience outlets, telephone, intercom/paging system, conduit for network computer system, air conditioned, and heated.
- Floor Finishes: Carpet.
- Wall Finishes: Painted Gypsum board.
- Ceiling Finishes: Acoustical tile ceiling.
- Lighting: Office Light Fixture. Refer to Chapter 4 for foot candle and fixture requirements.
- Define space with 66" high modular office partitions.

*(Operations)*

### Safety Manager

See Typical Workstation 2B

#### FUNCTION

- Open workspace for the Safety Manager.

#### RELATIONSHIP TO OTHER AREAS

- Adjacent to Drivers Room.
- Near Dispatch Suite.

#### COMMENTS / CHARACTERISTICS

- Furnishings: Refer to workstation graphic and graphic on Page 3.30.
- Utility Requirements: Grounded electrical convenience outlets, telephone, intercom/paging system, conduit for network computer system, air conditioned, and heated.
- Floor Finishes: Carpet.
- Wall Finishes: Painted Gypsum board.
- Ceiling Finishes: Acoustical tile ceiling.
- Lighting: Office Light Fixture. Refer to Chapter 4 for foot candle and fixture requirements.
- Define space with 66" high modular office partitions.

*(Operations)*

## Trainer

See Typical Workstation 2B

### FUNCTION

- Open workspace for the Trainer.

### RELATIONSHIP TO OTHER AREAS

- Adjacent to Drivers Room.
- Near Dispatch Suite.
- Near Training / Large Conference Room.

### COMMENTS / CHARACTERISTICS

- Furnishings: Refer to workstation graphic and graphic on Page 3.30.
- Utility Requirements: Grounded electrical convenience outlets, telephone, intercom/paging system, conduit for network computer system, air conditioned, and heated.
- Floor Finishes: Carpet.
- Wall Finishes: Painted Gypsum board.
- Ceiling Finishes: Acoustical tile ceiling.
- Lighting: Office Light Fixture. Refer to Chapter 4 for foot candle and fixture requirements.
- Define space with 66" high modular office partitions.

## (Operations)

## Road Supervisor

See Typical Workstation 2B

### FUNCTION

- Open workspace for the Road Supervisors.

### RELATIONSHIP TO OTHER AREAS

- Adjacent to Drivers Room.
- Near Dispatch Suite.

### COMMENTS / CHARACTERISTICS

- Furnishings: Refer to workstation graphic and graphic on Page 3.30.
- Utility Requirements: Grounded electrical convenience outlets, telephone, intercom/paging system, conduit for network computer system, air conditioned, and heated.
- Floor Finishes: Carpet.
- Wall Finishes: Painted Gypsum board.
- Ceiling Finishes: Acoustical tile ceiling.
- Lighting: Office Light Fixture. Refer to Chapter 4 for foot candle and fixture requirements.
- Define space with 66" high modular office partitions.

## (Operations)

## **File Storage**

*(Operations)*

### **FUNCTION**

- Open area for files and other sensitive materials stored in filing cabinets.

### **RELATIONSHIP TO OTHER AREAS**

- Adjacent to Operations Suite.

### **COMMENTS / CHARACTERISTICS**

- Furnishings: Two 4-drawer filing cabinets.
- Utility Requirements: Air conditioned and heated.
- Floor Finishes: Carpet or resilient flooring.
- Wall Finishes: Painted gypsum board.
- Ceiling Finishes: Acoustical tile ceiling.
- Lighting: Office Light Fixture. Refer to Chapter 4 for foot candle and fixture requirements.

## **Expansion Office**

*(Operations)*

See Typical Module 1

### **FUNCTION**

- Enclosed private office for future expansion.

### **RELATIONSHIP TO OTHER AREAS**

- Near Operations Suite.

### **COMMENTS / CHARACTERISTICS**

- Furnishings: Refer to module graphic.
- Utility Requirements: Grounded electrical convenience outlets, telephone, intercom/paging system, conduit for network computer system, air conditioned, and heated.
- Window to outside if possible. Windows to be operable.
- Floor Finishes: Carpet
- Wall Finishes: Painted gypsum board.
- Ceiling Finishes: Acoustical tile ceiling.
- Lighting: Office Light Fixture. Refer to Chapter 4 for foot candle and fixture requirements.
- Acoustically separated from surround spaces.

## STORAGE ROOM

(OPERATIONS)

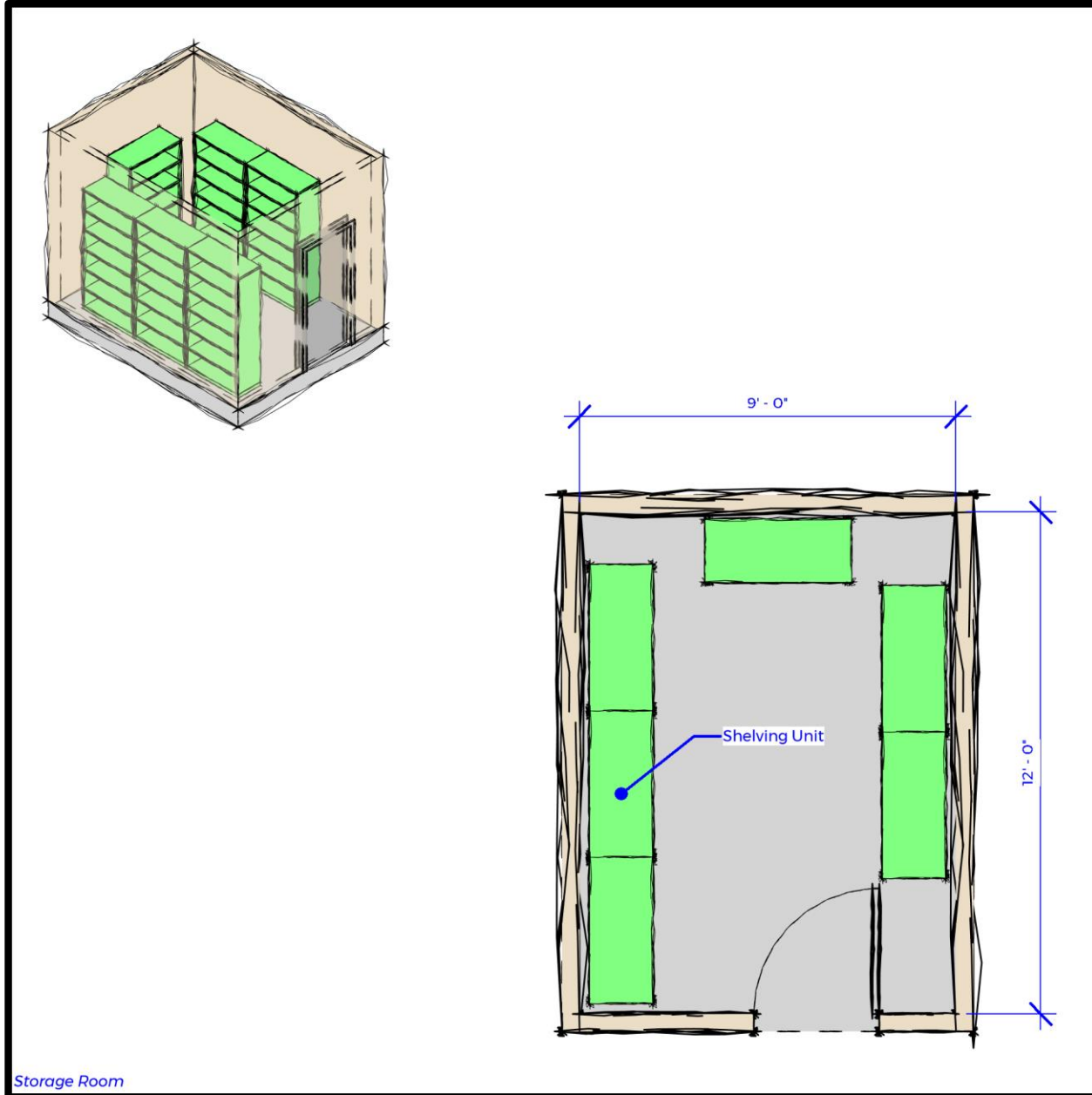

Storage Room

### Function

- Enclosed area for storage of files for access by Operations personnel.

### Relationship to other Areas

- Adjacent to Operations areas.

### Comments / Characteristics

- Furnishings: Refer to graphic on this page. Six shelving units to accommodate up to 21 storage boxes per shelving unit for up to 126 file storage boxes total.
- Utility Requirements: Grounded electrical convenience outlet near door, air conditioned, and heated.
- Floor Finishes: Resilient flooring.
- Wall Finishes: Painted gypsum board.
- Ceiling Finishes: Acoustical ceiling.
- Lighting: Service Light Fixture – Storage rooms: Refer to Chapter 4 for foot candle and fixture requirements.

## LONG TERM STORAGE – LARGE

(OPERATIONS)

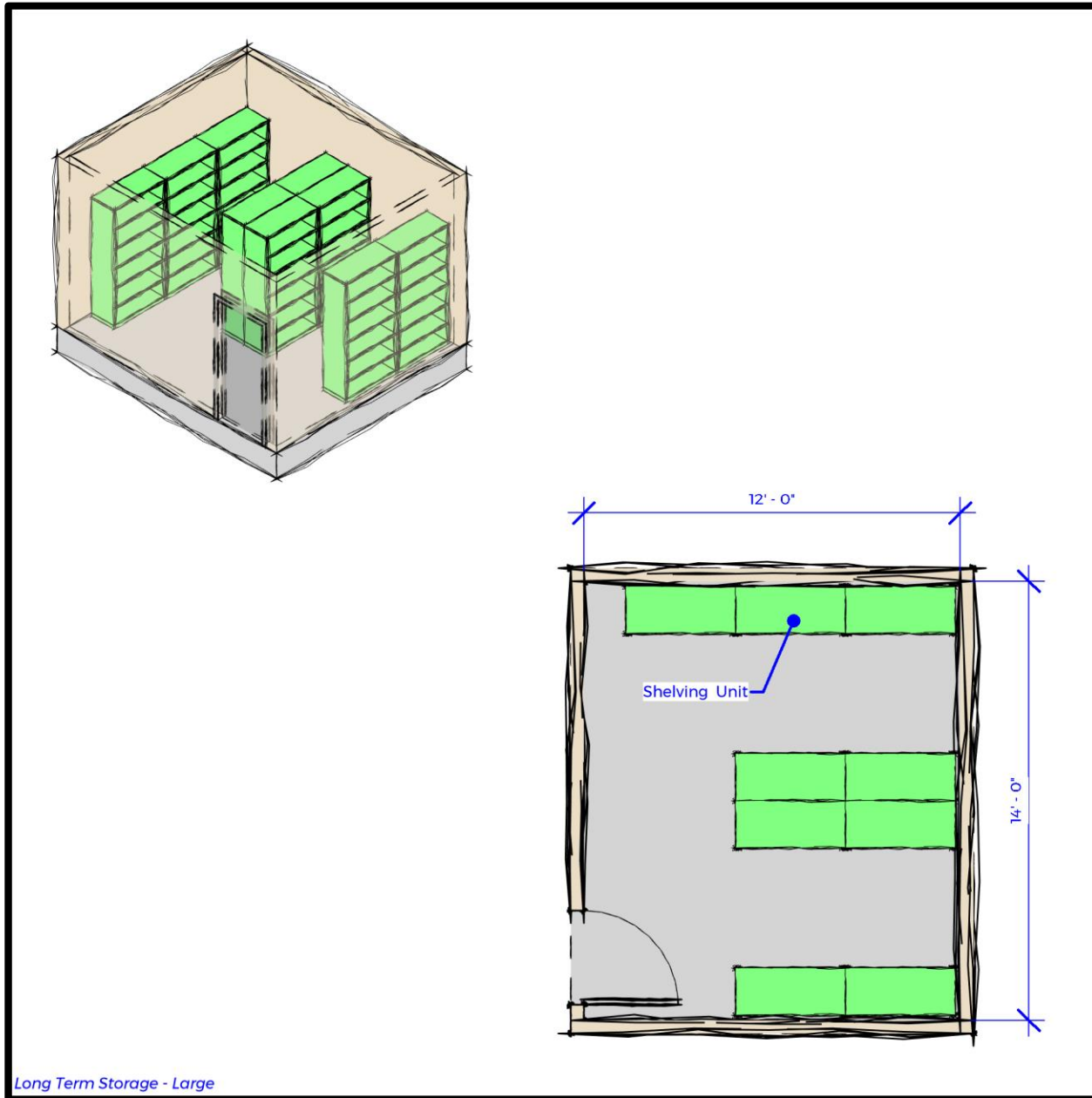

Long Term Storage - Large

### Function

- Enclosed area for storage of archive files for intermittent access.

### Relationship to other Areas

- Adjacent to Operations areas.

### Comments / Characteristics

- Furnishings: Refer to graphic on this page. Nine shelving units to accommodate up to 21 storage boxes per shelving unit for up to 189 file storage boxes total.
- Utility Requirements: Grounded electrical convenience outlet near door, air conditioned, and heated.
- Floor Finishes: Resilient flooring.
- Wall Finishes: Painted gypsum board.
- Ceiling Finishes: Acoustical ceiling.
- Lighting: Service Light Fixture – Storage rooms: Refer to Chapter 4 for foot candle and fixture requirements.

## COIN ROOM

(OPERATIONS)

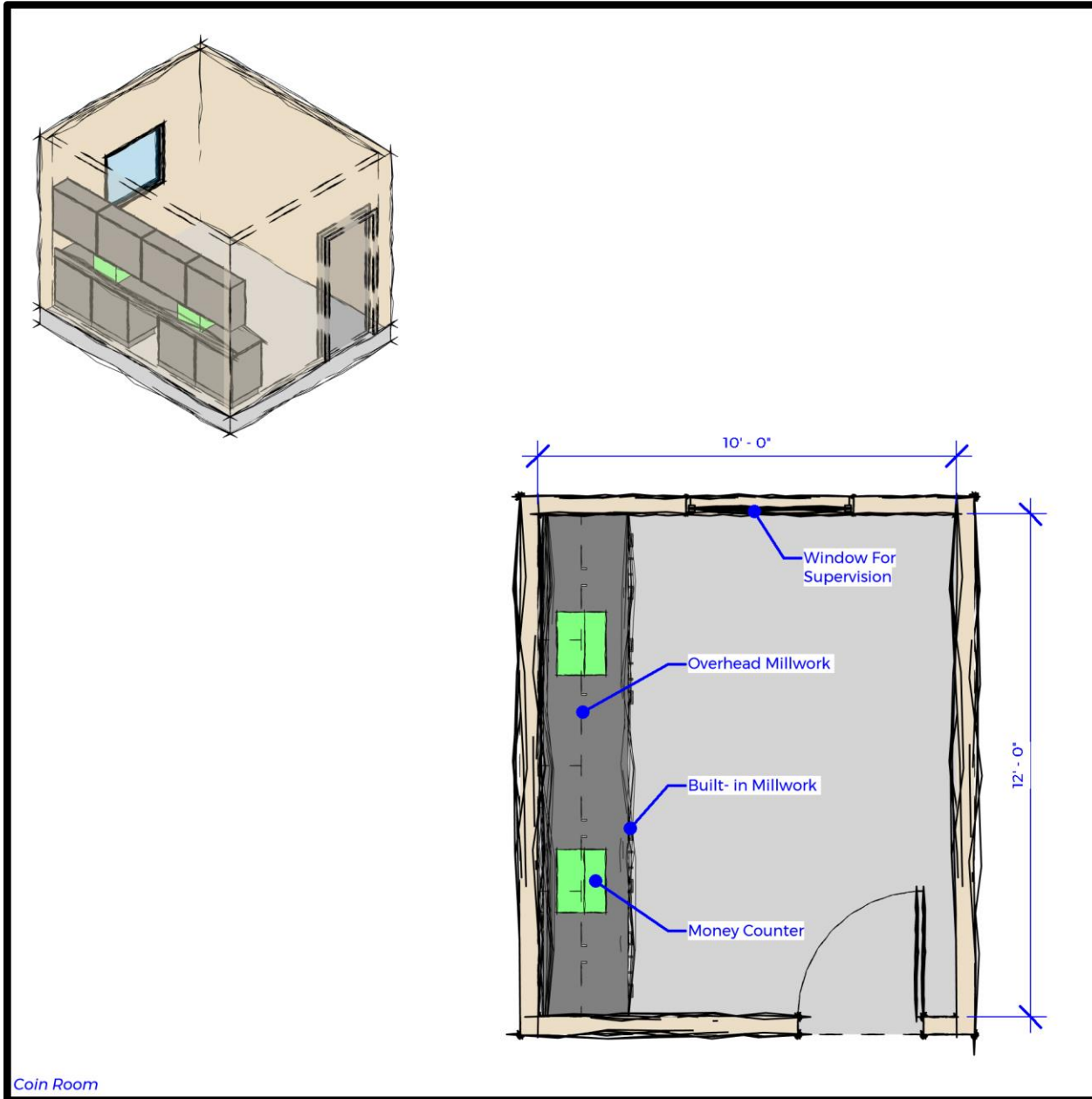

Coin Room

### Function

- Enclosed secure area for counting money retrieved from bus vaults and for pulled vault storage.

### Relationship to other Areas

- Adjacent to Operations Suite.

### Comments / Characteristics

- Furnishings: Refer to graphic on this page.
- Utility Requirements: Grounded electrical convenience outlets, telephone, intercom/paging system, air conditioned, and heated. Provide dedicated air conditioning unit.
- Floor Finishes: Resilient flooring.
- Wall Finishes: Abrasion resistant painted gypsum board and/or concrete block.
- Ceiling Finishes: Acoustical ceiling.
- Lighting: Office Light Fixture. Refer to Chapter 4 for foot candle and fixture requirements.
- Acoustically separated from surround spaces.
- Window for supervision access of counting process without accessing room.

## ENTRY VESTIBULE

(OPERATIONS)

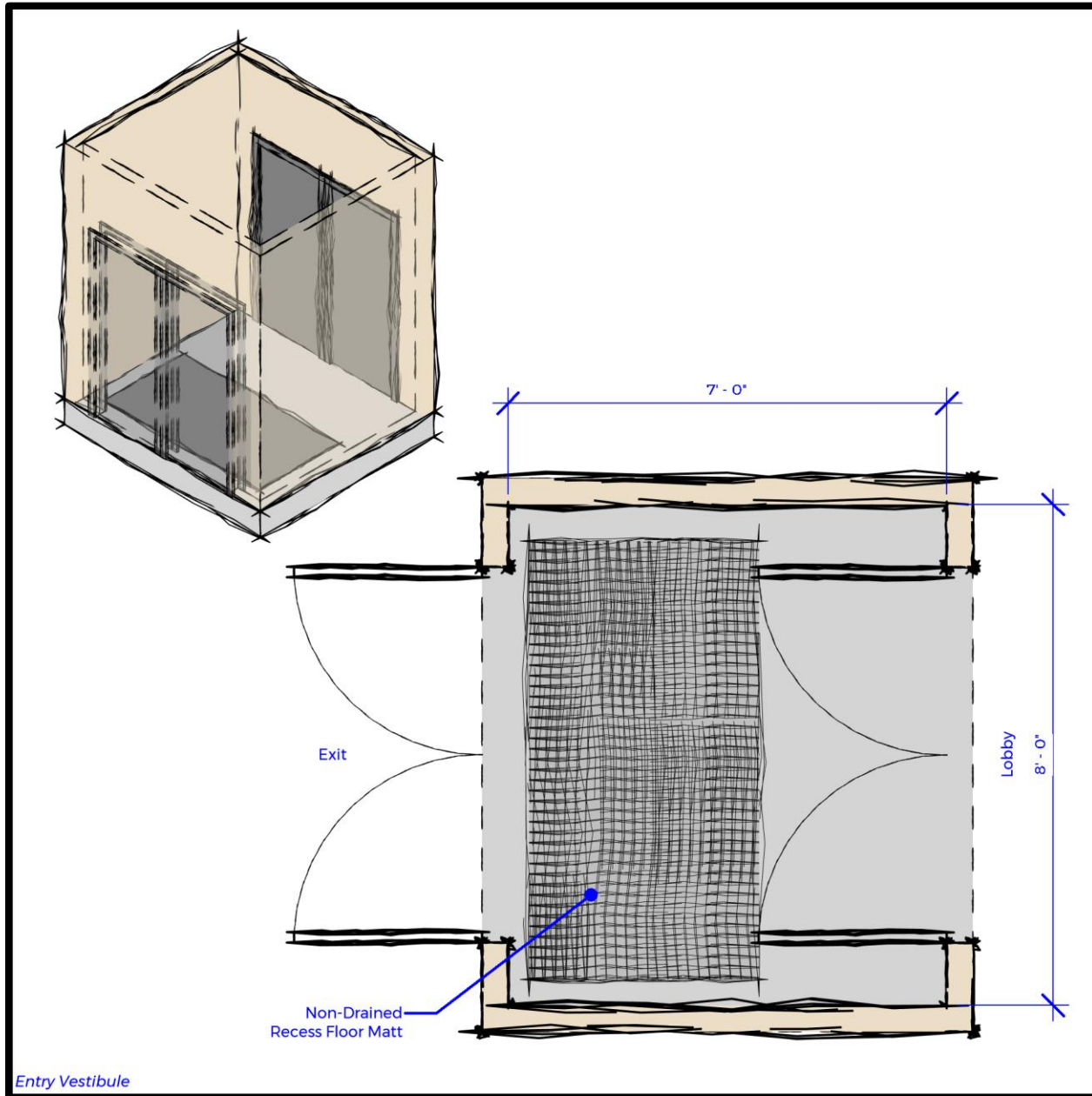

### Function

- Entry area before Lobby.

### Relationship to other Areas

- At entrance of Dispatch.

### Comments / Characteristics

- Furnishings: None.
- Utility requirements: Grounded electrical convenience outlets, air conditioned and heated.
- Window to outside.
- Floor Finishes: Resilient flooring with non-drained recessed floor matt.
- Wall Finishes: Painted gypsum board.
- Ceiling Finishes: Acoustical tile ceiling.
- Lighting: Office Light Fixture. Refer to Chapter 4 for foot candle and fixture requirements.

LOBBY – DISPATCH

(OPERATIONS)

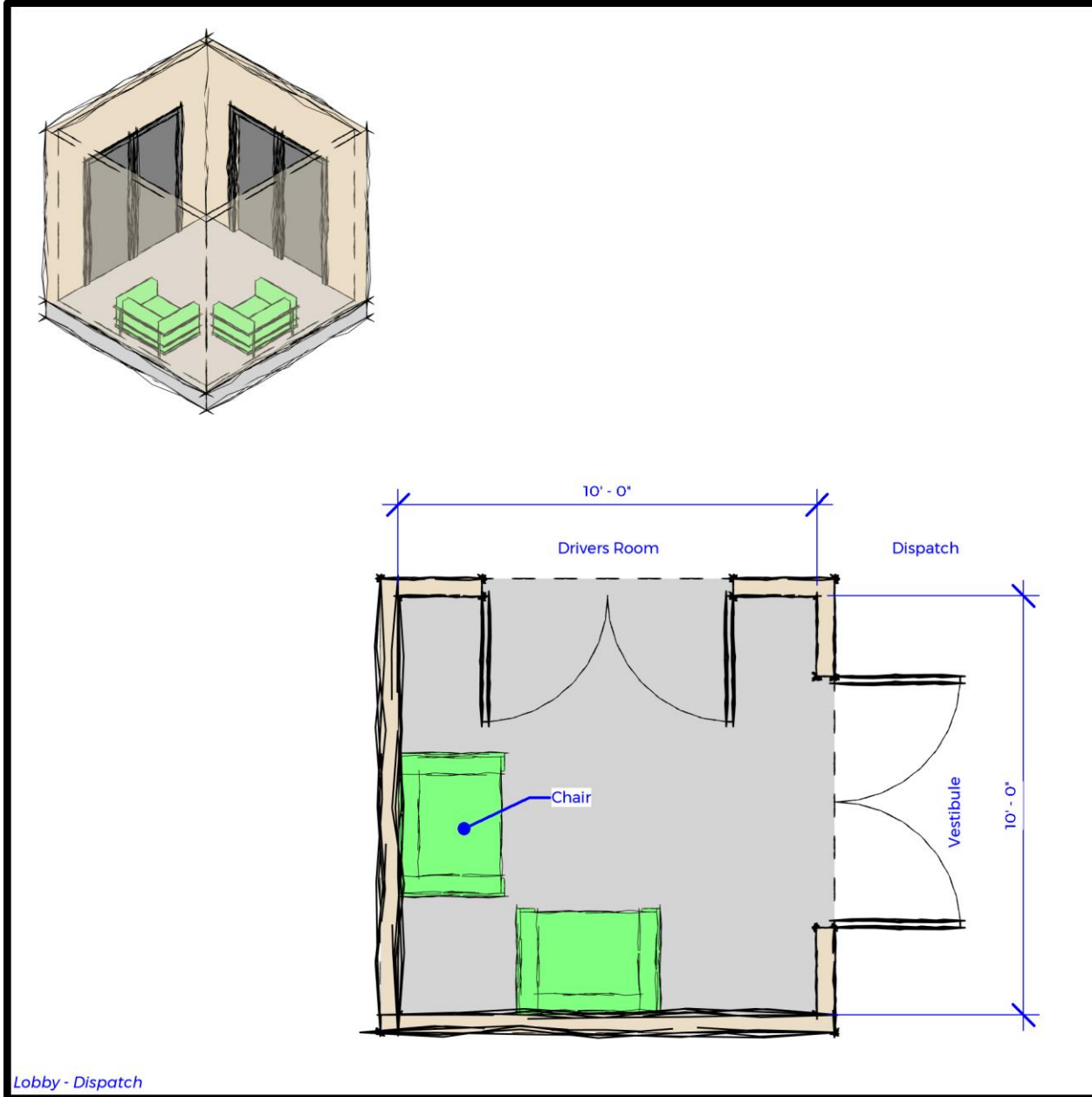

**Function**

- Dispatch lobby area with seating for up to 2 people.

**Relationship to other Areas**

- Adjacent to Dispatch Window.
- Adjacent to Vestibule.

**Comments / Characteristics**

- Furnishings: Refer to graphic on this page.
- Utility requirements: Grounded electrical convenience outlets, intercom/paging system, air conditioned and heated.
- Window to outside if possible. Window to be fixed.
- Floor Finishes: Resilient flooring.
- Wall Finishes: Painted gypsum board and/or concrete block.
- Ceiling Finishes: Acoustical tile ceiling.
- Lighting: Office Light Fixture. Refer to Chapter 4 for foot candle and fixture requirements.



## DISPATCH SUITE

(OPERATIONS)

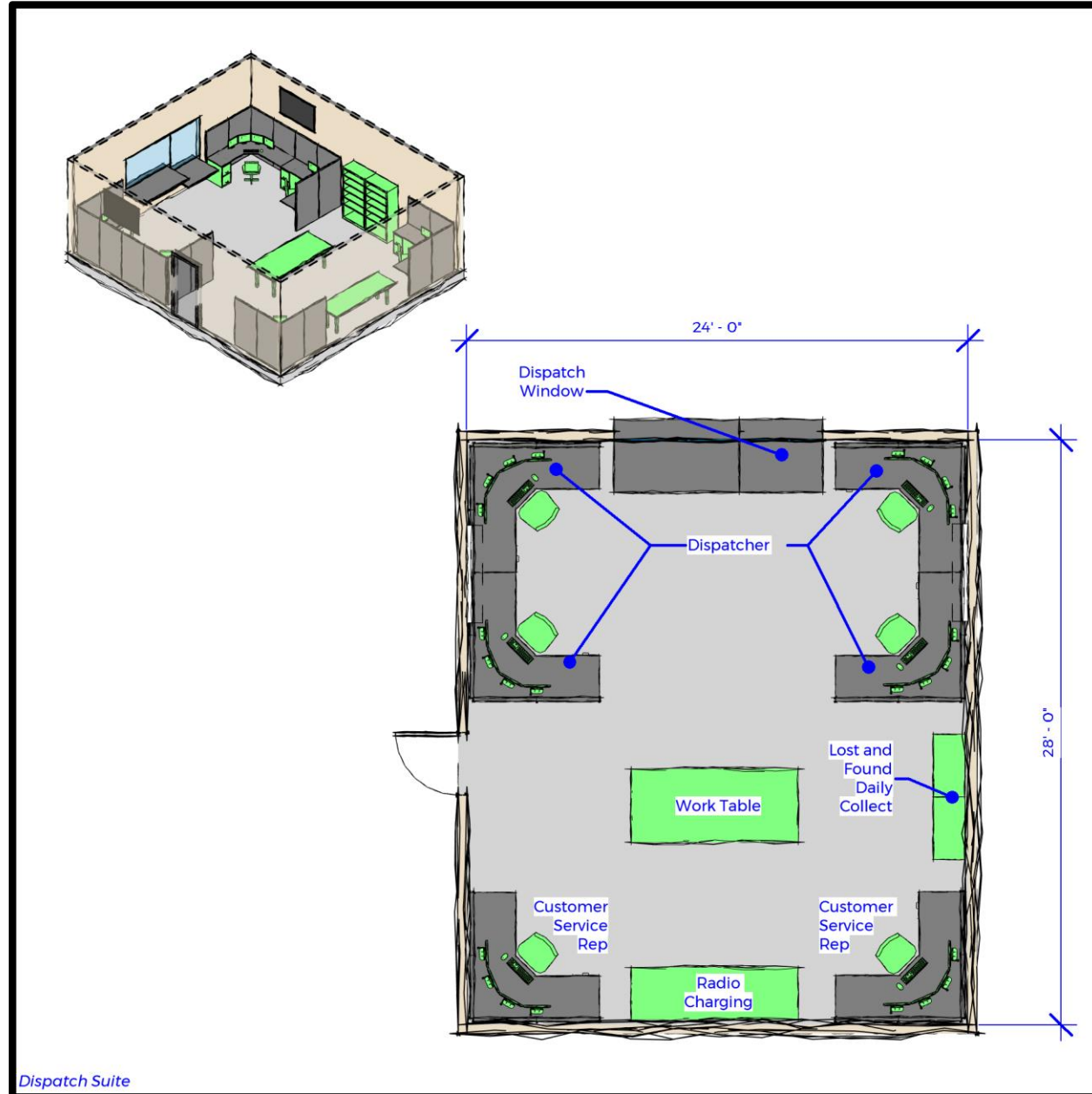

### Function

- Enclosed room to house dispatching functions, dispatching workstations, and support areas.

### Relationship to other Areas

- Adjacent to Drivers Room and Dispatch Lobby.
- Near Operations Suite.

### Comments / Characteristics

- Furnishings: Refer to graphic on this page.
- Utility Requirements: Grounded electrical convenience outlets, telephone, intercom/paging system, conduit for network computer system, air conditioned, and heated.
- Window to outside with view of bus parking, bus site entry / exit if possible. Window to be fixed. View of Dispatch Lobby to allow secure access via remote lock control into Drivers Room.
- Floor Finishes: Resilient flooring or carpet.
- Wall Finishes: Painted gypsum board.
- Ceiling Finishes: Acoustical tile ceiling.
- Lighting: Office Light Fixture. Refer to Chapter 4 for foot candle and fixture requirements.

### Dispatch Window (Dispatcher)

See Typical Workstation 1B

#### FUNCTION

- Counter space for driver interaction with Dispatcher.

#### RELATIONSHIP TO OTHER AREAS

- Adjacent to Driver Check-In.
- Adjacent to Drivers Room.
- Near Operations Suite.

#### COMMENTS / CHARACTERISTICS

- Refer to graphic on previous page.
- Utility Requirements: Grounded electrical convenience outlets, telephone, intercom/paging system, conduit for network computer system, air conditioned, and heated.
- Floor Finishes: Resilient flooring or carpet.
- Wall Finishes: Painted gypsum board.
- Ceiling Finishes: Acoustical tile ceiling.
- Lighting: Office Light Fixture. Refer to Chapter 4 for foot candle and fixture requirements.

### (Operations)

### Customer Service Representative

See Typical Workstation 1B

#### FUNCTION

- Open workspace for the Customer Service Representative.

#### RELATIONSHIP TO OTHER AREAS

- Adjacent to Operations Suite.
- Near Drivers Room.

#### COMMENTS / CHARACTERISTICS

- Furnishings: Refer to workstation graphic.
- Utility Requirements: Grounded electrical convenience outlets, telephone, intercom/paging system, conduit for network computer system, air conditioned, and heated.
- Floor Finishes: Carpet.
- Wall Finishes: Painted Gypsum board.
- Ceiling Finishes: Acoustical ceiling.
- Lighting: Office Light Fixture. Refer to Chapter 4 for foot candle and fixture requirements.
- Define space with 66" high modular office partitions.

### (Operations)

## Lost and Found Daily Collect

*(Operations)*

### FUNCTION

- Shelving unit to hold lost and found items collected daily from returning bus routes.

### RELATIONSHIP TO OTHER AREAS

- Adjacent to Dispatch.

### COMMENTS / CHARACTERISTICS

- Furnishings: Shelving unit with plastic bins for storage of items.
- Utility Requirements: None.
- Floor Finishes: None.
- Wall Finishes: None.
- Ceiling Finishes: None.
- Lighting: None.

## Storage

*(Operations)*

### FUNCTION

- Enclosed area for storage of files for access by Dispatch personnel.

### RELATIONSHIP TO OTHER AREAS

- Adjacent to Dispatch Suite.

### COMMENTS / CHARACTERISTICS

- Furnishings: Built-in shelving into closet.
- Utility Requirements: None.
- Floor Finishes: Resilient flooring.
- Wall Finishes: Painted gypsum board.
- Ceiling Finishes: Acoustical ceiling.
- Lighting: Service Light Fixture – Storage rooms: Refer to Chapter 4 for foot candle and fixture requirements.

COPY / WORK ROOM

(OPERATIONS)

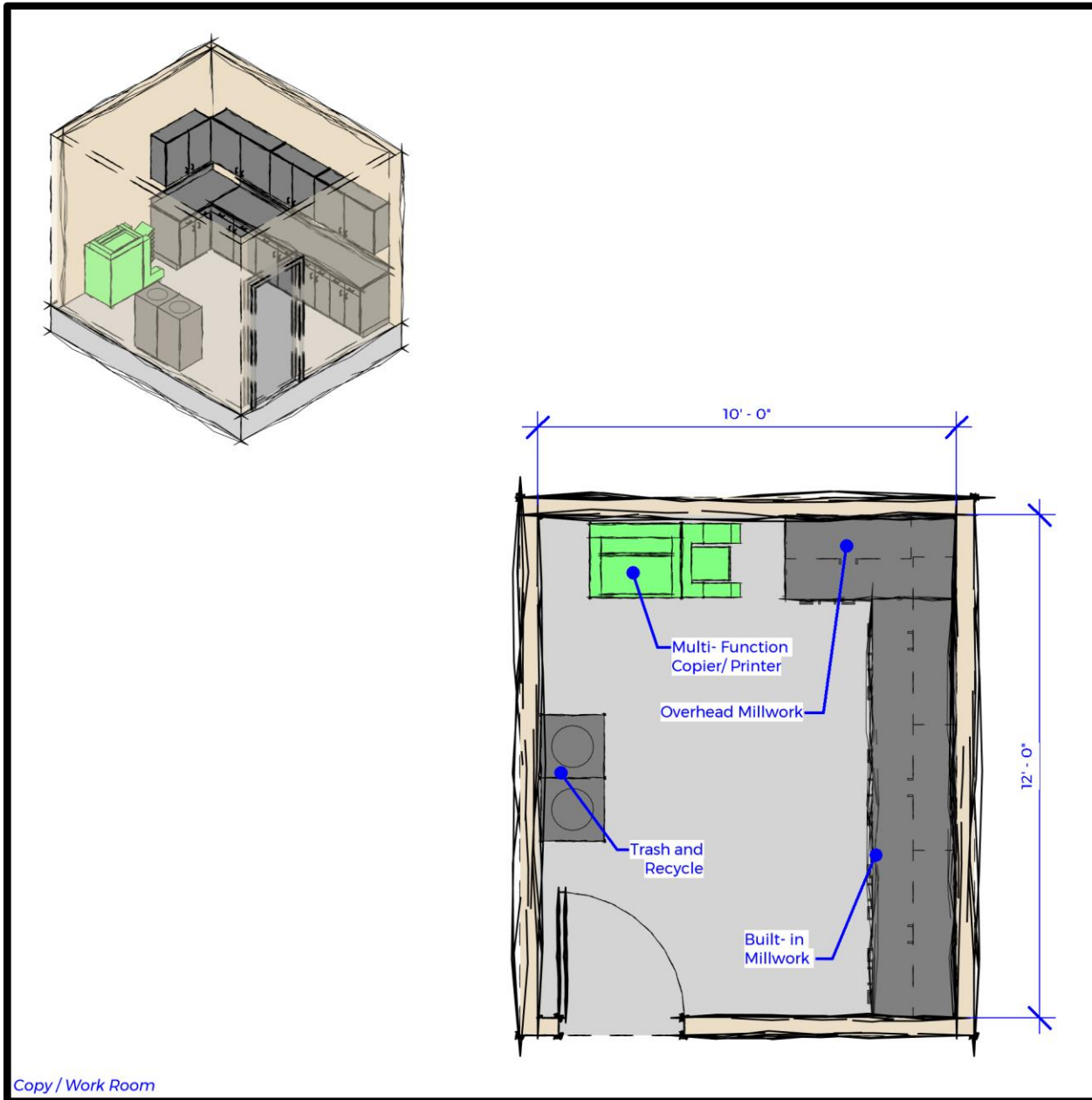

**Function**

- Designated area for multi-function copier/scanner/printer, cutting board, supply storage, and work surfaces.

**Relationship to other Areas**

- Convenience access to Dispatch personnel.

**Comments / Characteristics**

- Furnishings: Refer to graphic on this page.
- Utility Requirements: Grounded electrical convenience outlets, telephone, intercom/paging system, conduit for network computer system, air conditioned, and heated. Provide electrical outlets above counter back splash for counter mounted equipment.
- Floor Finishes: Resilient flooring.
- Wall Finishes: Painted gypsum board.
- Ceiling Finishes: Acoustical tile ceiling.
- Lighting: Office Light Fixture. Refer to Chapter 4 for foot candle and fixture requirements.

## CONFERENCE – SMALL

(OPERATIONS)

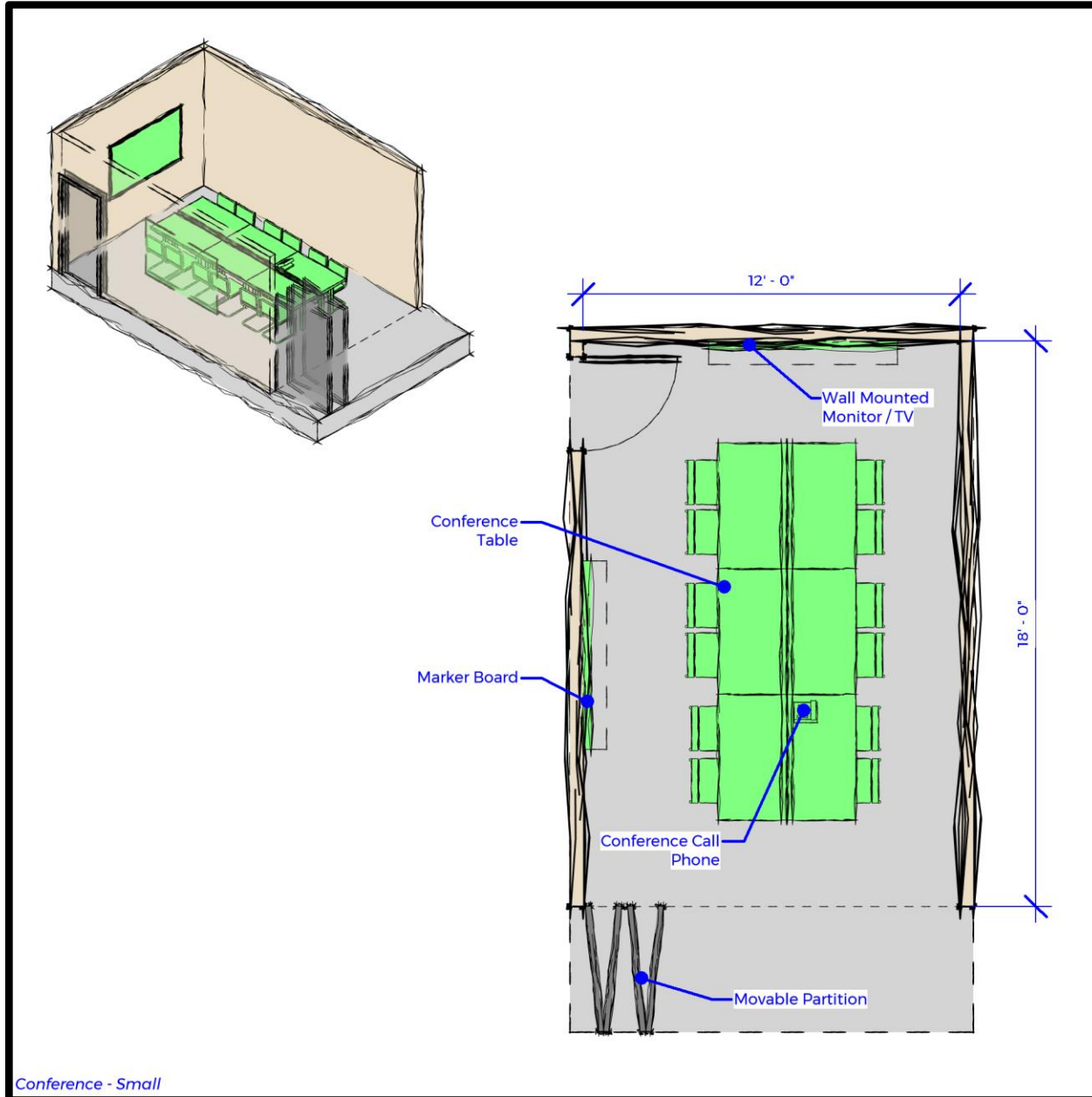

Conference - Small

### Function

- Area for meetings for up to 10 people.

### Relationship to other Areas

- Adjacent to Training / Large Conference Room.
- Convenient access to Operations Suite and Dispatch Suite.

### Comments / Characteristics

- Furnishings: Refer to graphic on this page.
- Utility Requirements: Grounded electrical convenience outlets, telephone, intercom/paging system, conduit for network computer system tied from ceiling projection to wall below television to floor box below table to allow laptop on table to connect, air conditioned, and heated.
- Window to outside if possible. Windows to be operable with black out shade.
- Floor Finishes: Resilient flooring.
- Wall Finishes: Painted gypsum board.
- Ceiling Finishes: Acoustical tile ceiling.
- Lighting: Office Light Fixture Dimmable. Refer to Chapter 4 for foot candle and fixture requirements. and dimmable down-lights to either/both television or projection screen. Lighting design shall have ability to dim the front area near projection screen.
- Acoustically separated from surrounding spaces.

## TRAINING / LARGE CONFERENCE ROOM

(OPERATIONS)

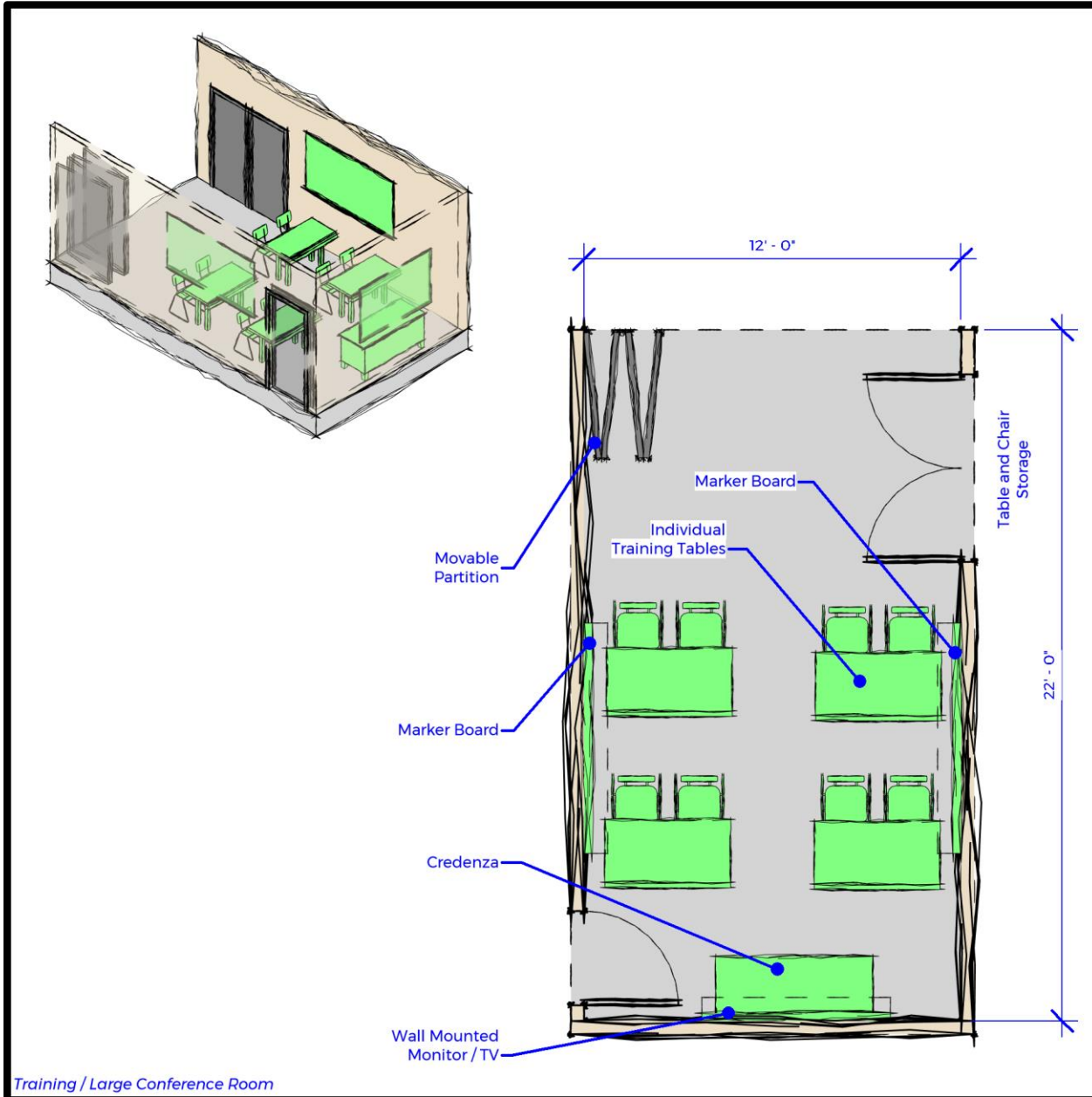

### Function

- Enclosed area for training sessions, comfortably accommodating up to 8 at tables.

### Relationship to other Areas

- Adjacent to small Conference.
- Convenient access to Operations Suite and Dispatch Suite.

### Comments / Characteristics

- Furnishings: Refer to graphic on this page.
- Utility requirements: Grounded electrical convenience outlets, telephone, intercom/paging system, television cable, conduit for network computer system, including conduit tied from ceiling mounted projector to wall behind trainer/presenter desk, air conditioned, and heated.
- Floor Finishes: Resilient flooring.
- Wall Finishes: Painted gypsum board.
- Ceiling Finishes: Acoustical tile ceiling.
- Lighting: Office Light Fixture Dimmable. Refer to Chapter 4 for foot candle and fixture requirements and dimmable downlights. Lighting design shall have the capability of separately controlling the area near the projector screen.
- Acoustically separated from surrounding spaces.



## TABLE AND CHAIR STORAGE

(OPERATIONS)

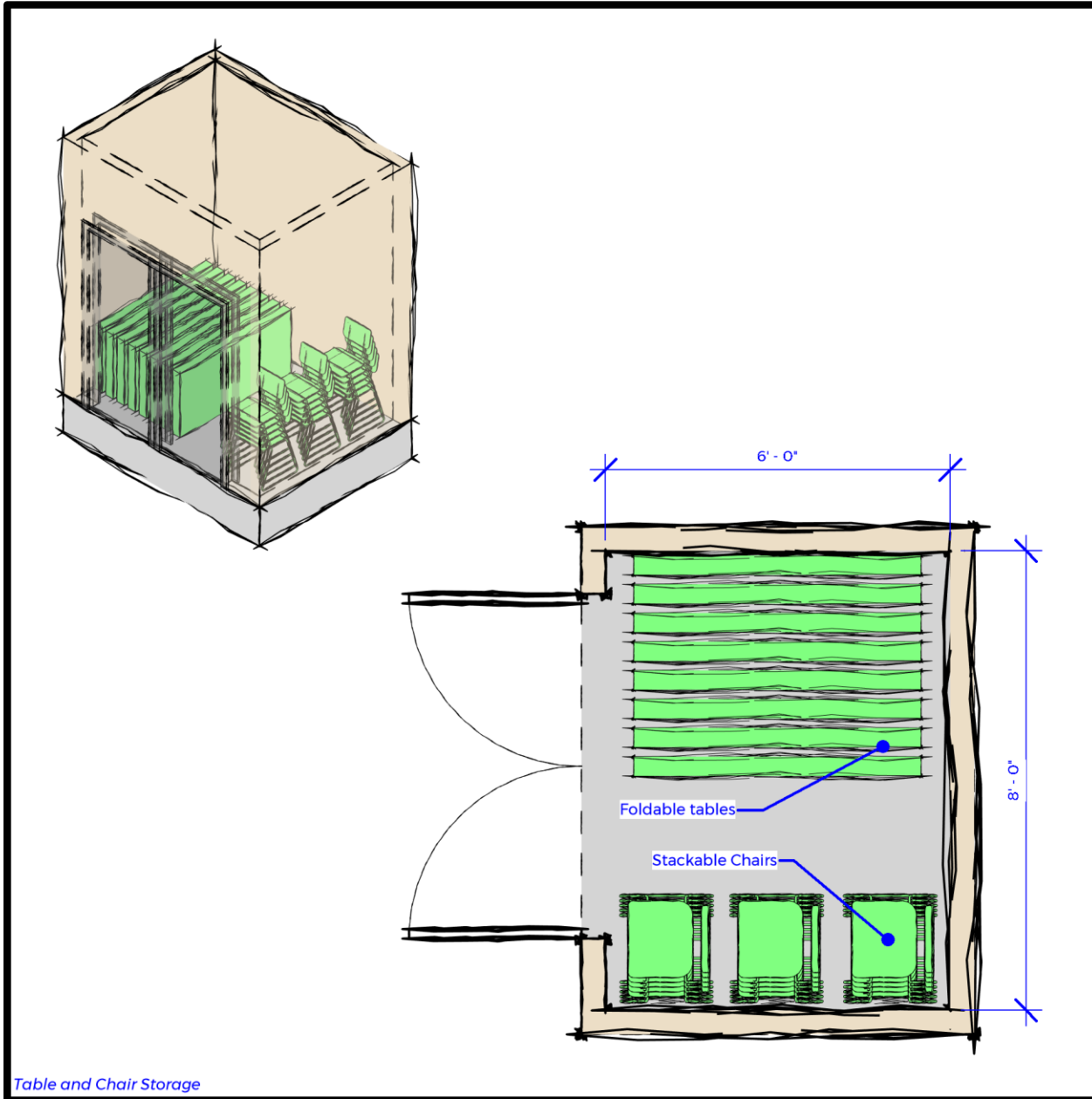

### Function

- Enclosed area for storage of tables and chairs from Training / Large Conference Room.

### Relationship to other Areas

- Adjacent to Training / Large Conference Room.

### Comments / Characteristics

- Furnishings: Refer to graphic on this page.
- Utility Requirements: Grounded electrical convenience outlets, air conditioned, and heated.
- Floor Finishes: Resilient flooring.
- Wall Finishes: Painted gypsum board.
- Ceiling Finishes: Acoustical ceiling.
- Lighting: Service Light Fixture – Storage rooms. Refer to Chapter 4 for foot candle and fixture requirements.

## DRIVER CHECK-IN

(OPERATIONS)

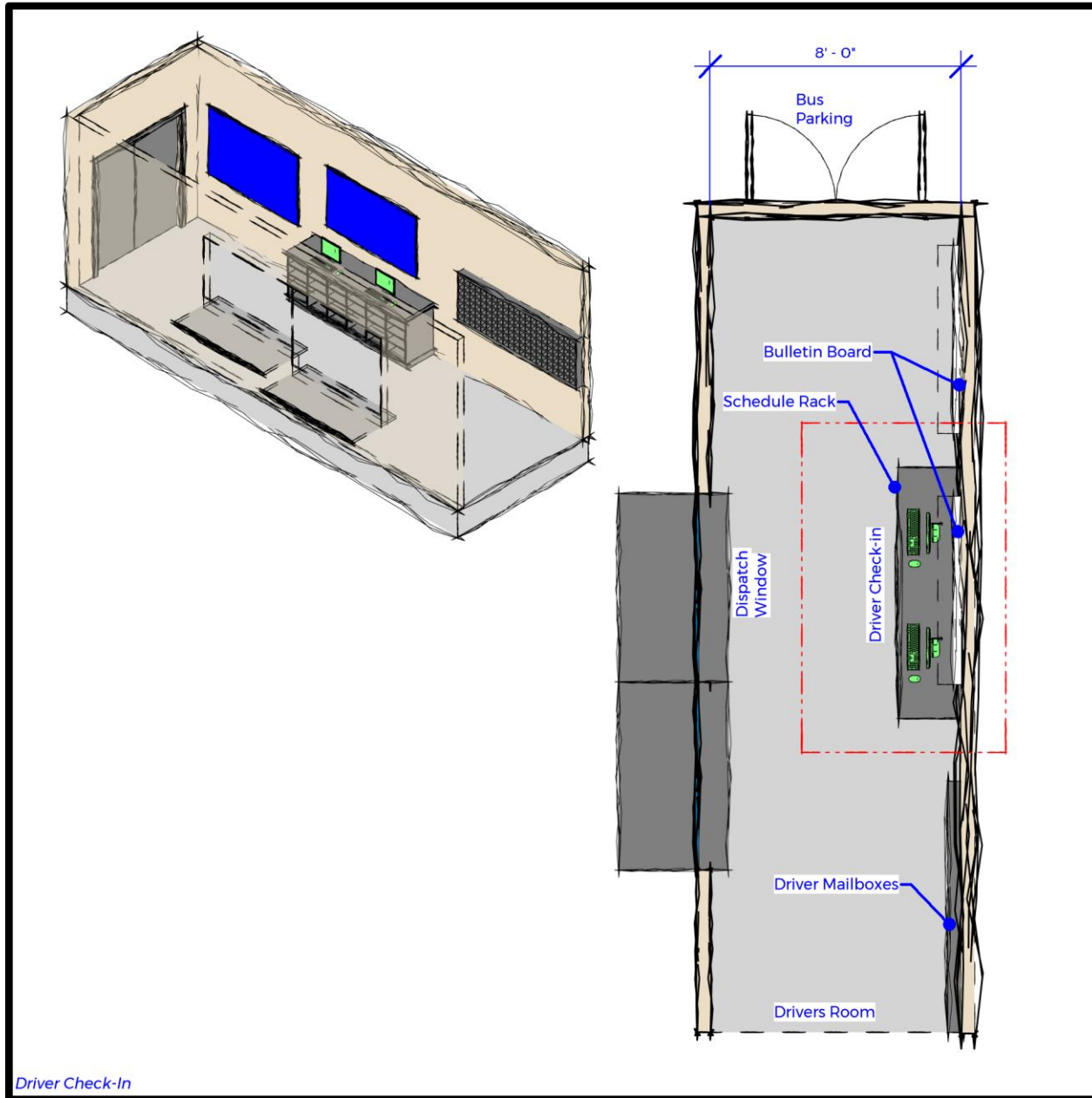

Driver Check-In

### Function

- Open area for drivers to check in at Dispatch Window.

### Relationship to other Areas

- Adjacent to Dispatch Window and Drivers Room.
- Exits to Employee Parking and Bus Parking.

### Comments / Characteristics

- Furnishings: Refer to graphic on this page.
- Utility Requirements: Grounded electrical convenience outlets, telephone, intercom/paging system, conduit for 2 network computer systems, air conditioned, and heated.
- Window to outside. Windows to be fixed.
- Schedule racks, document board, 2 computer stations.
- Floor Finishes: Resilient flooring.
- Wall Finishes: Painted gypsum board and/or concrete block.
- Ceiling Finishes: Acoustical tile ceiling.
- Lighting: Office Light Fixture. Refer to Chapter 4 for foot candle and fixture requirements.



## DRIVER MAILBOXES

(OPERATIONS)

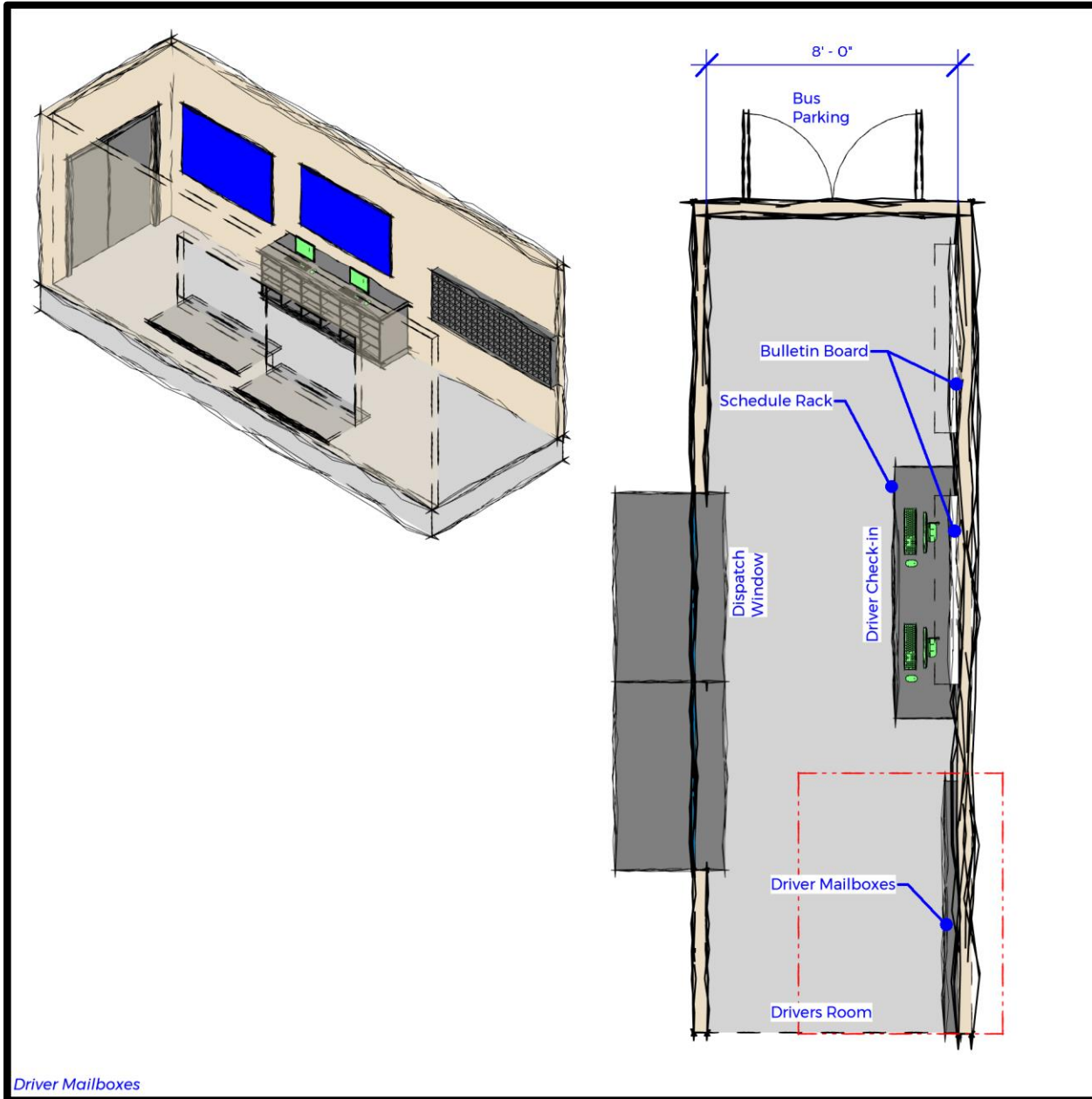

Driver Mailboxes

### Function

- Open area for driver mailboxes.

### Relationship to other Areas

- Adjacent to Driver Check-In.
- Near Drivers Room.

### Comments / Characteristics

- Furnishings: 100 locking secure mailboxes, accessible from front.
- Utility Requirements: None.
- Floor Finishes: None.
- Wall Finishes: None.
- Ceiling Finishes: None.
- Lighting: None.

## DRIVERS ROOM

(OPERATIONS)

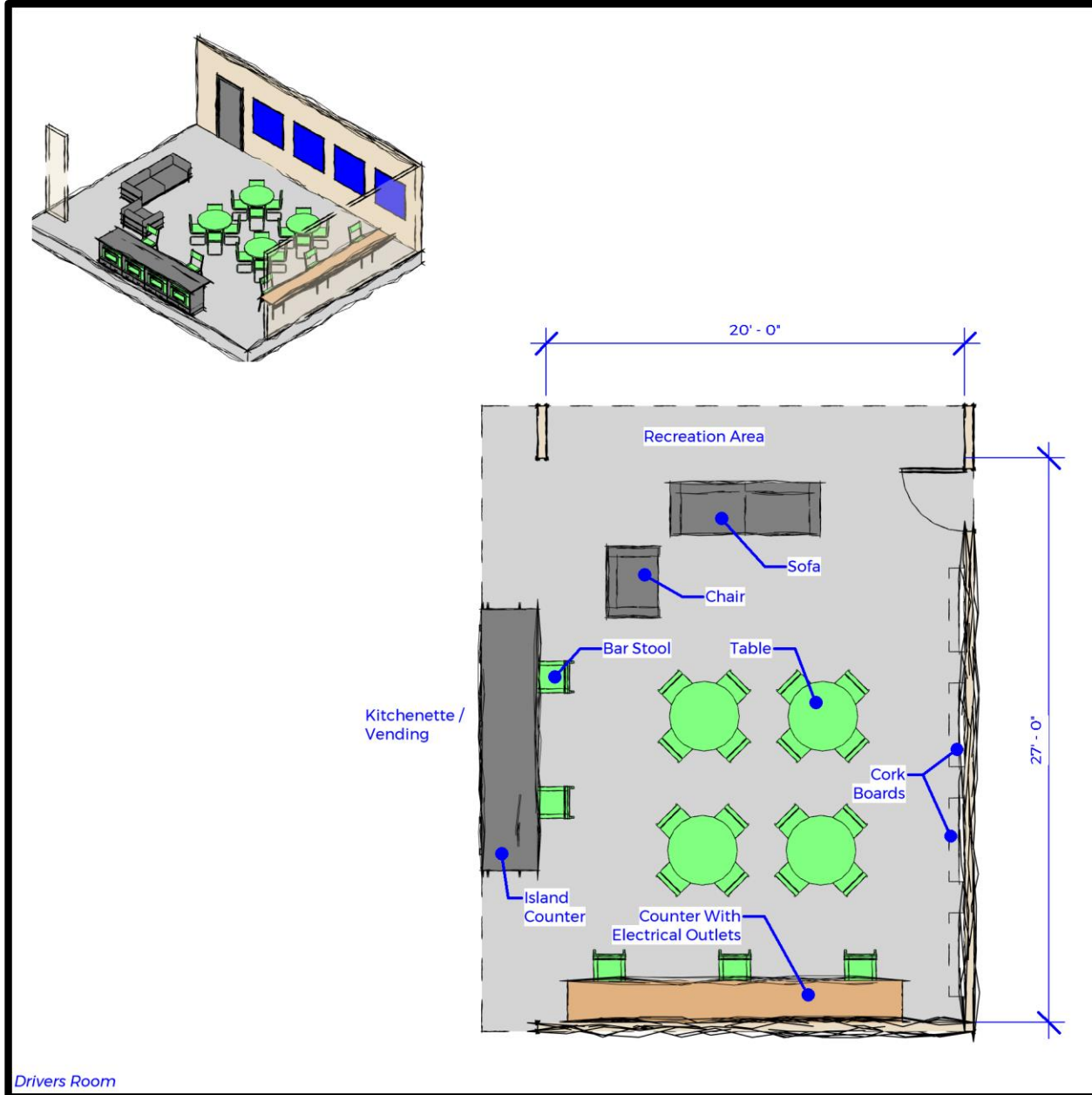

### Function

- Enclosed area for Drivers' use before, between, and after shifts.

### Relationship to other Areas

- Convenient access to Check-In area, Recreation Area, Kitchenette / Vending, and Restrooms.

### Comments / Characteristics

- Furnishings: Refer to graphic on this page.
- Utility Requirements: Grounded electrical convenience outlets, telephone, air conditioned, and heated.
- Floor Finishes: Resilient flooring.
- Wall Finishes: Painted gypsum board and/or concrete block.
- Ceiling Finishes: Acoustical tile ceiling.
- Lighting: Office Light Fixture. Refer to Chapter 4 for foot candle and lighting requirements.

## RECREATION AREA

(OPERATIONS)

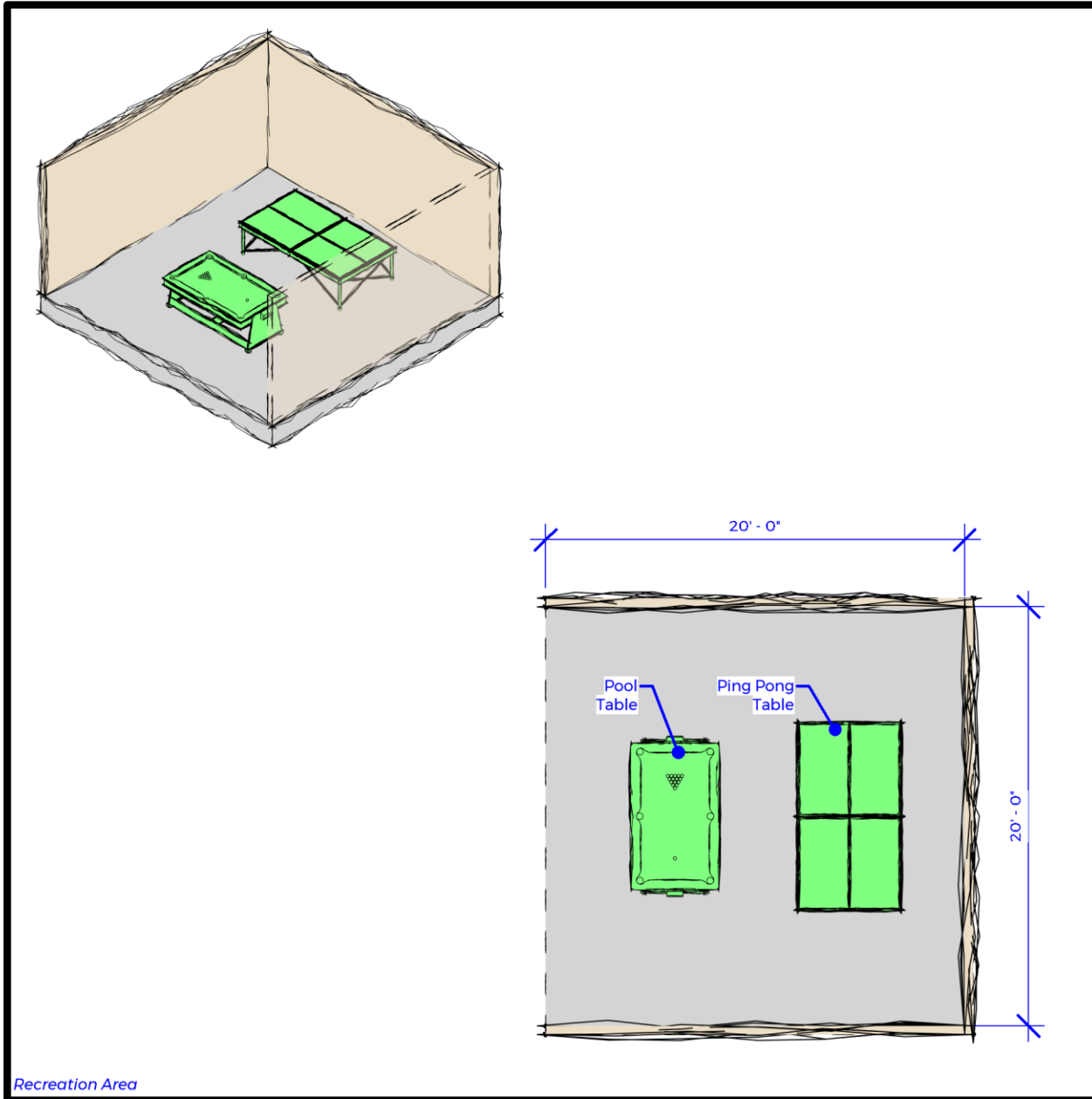

### Function

- Open area for recreational activities.

### Relationship to other Areas

- Adjacent to Drivers Room.

### Comments / Characteristics

- Furnishings: Refer to graphics on this page.
- Utility Requirements: Grounded electrical convenience outlets, telephone, air conditioned, and heated.
- Floor Finishes: Resilient flooring.
- Wall Finishes: Painted gypsum board and/or concrete block.
- Ceiling Finishes: Acoustical tile ceiling.
- Lighting: Office Light Fixture. Refer to Chapter 4 for foot candle and lighting requirements.
- Acoustically isolated from surrounding spaces.

## KITCHENETTE / VENDING

(OPERATIONS)

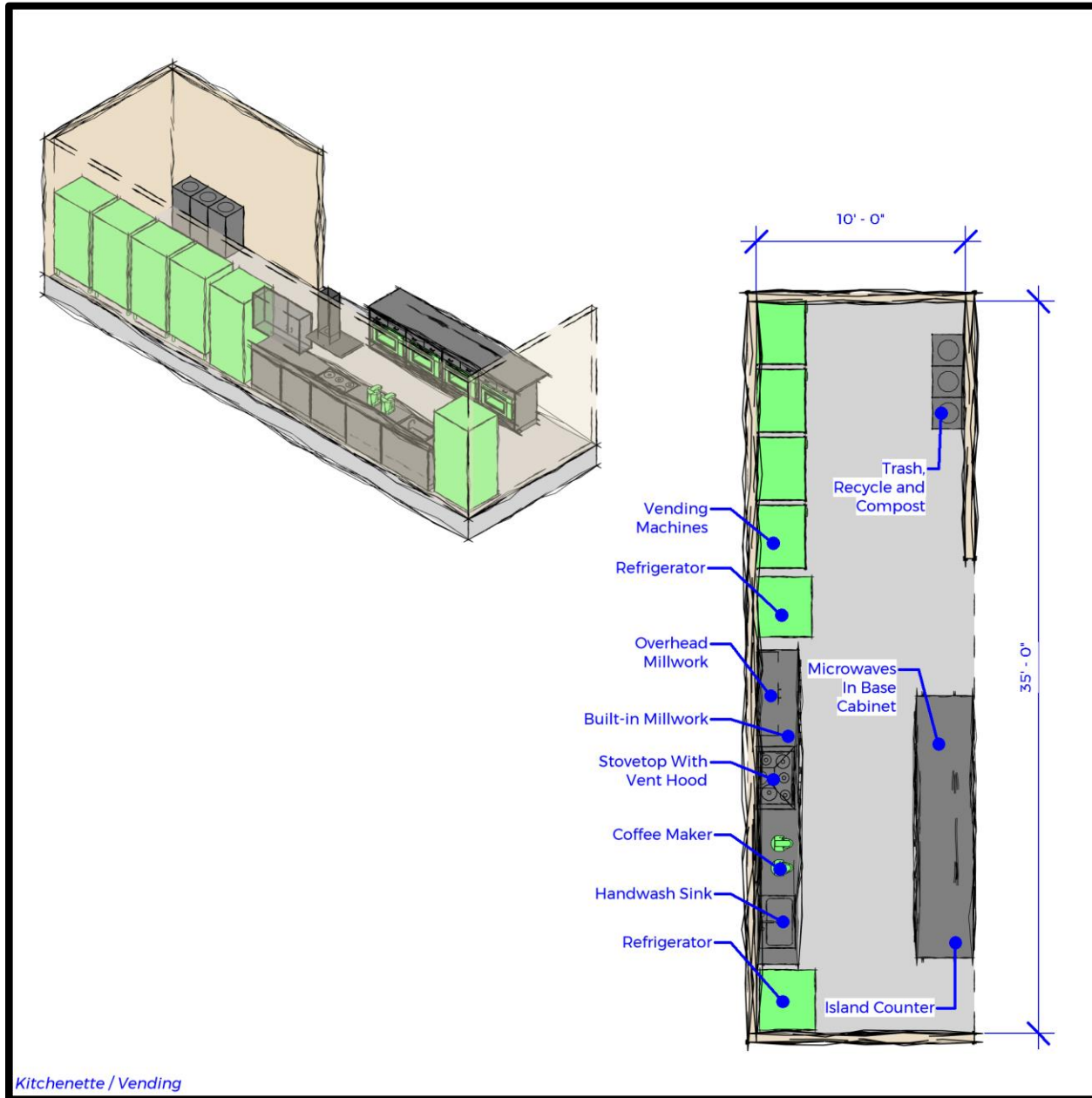

Kitchenette / Vending

### Function

- Enclosed alcove area for minor food preparation and space for vendor maintained vending machines.

### Relationship to other Areas

- Adjacent to Drivers Room and Recreation Area.

### Comments / Characteristics

- Furnishings: Refer to graphic on this page.
- Utility Requirements: Grounded electrical convenience outlets, intercom/paging system, air conditioned, and heated.
- Floor Finishes: Resilient flooring.
- Wall Finishes: Painted gypsum board.
- Ceiling Finishes: Acoustical tile ceiling.
- Lighting: Office Light Fixture: Refer to Chapter 4 for foot candle and lighting requirements.
- Separate network and Wi-Fi for vendor maintained vending machines.

## QUIET ROOM

(OPERATIONS)

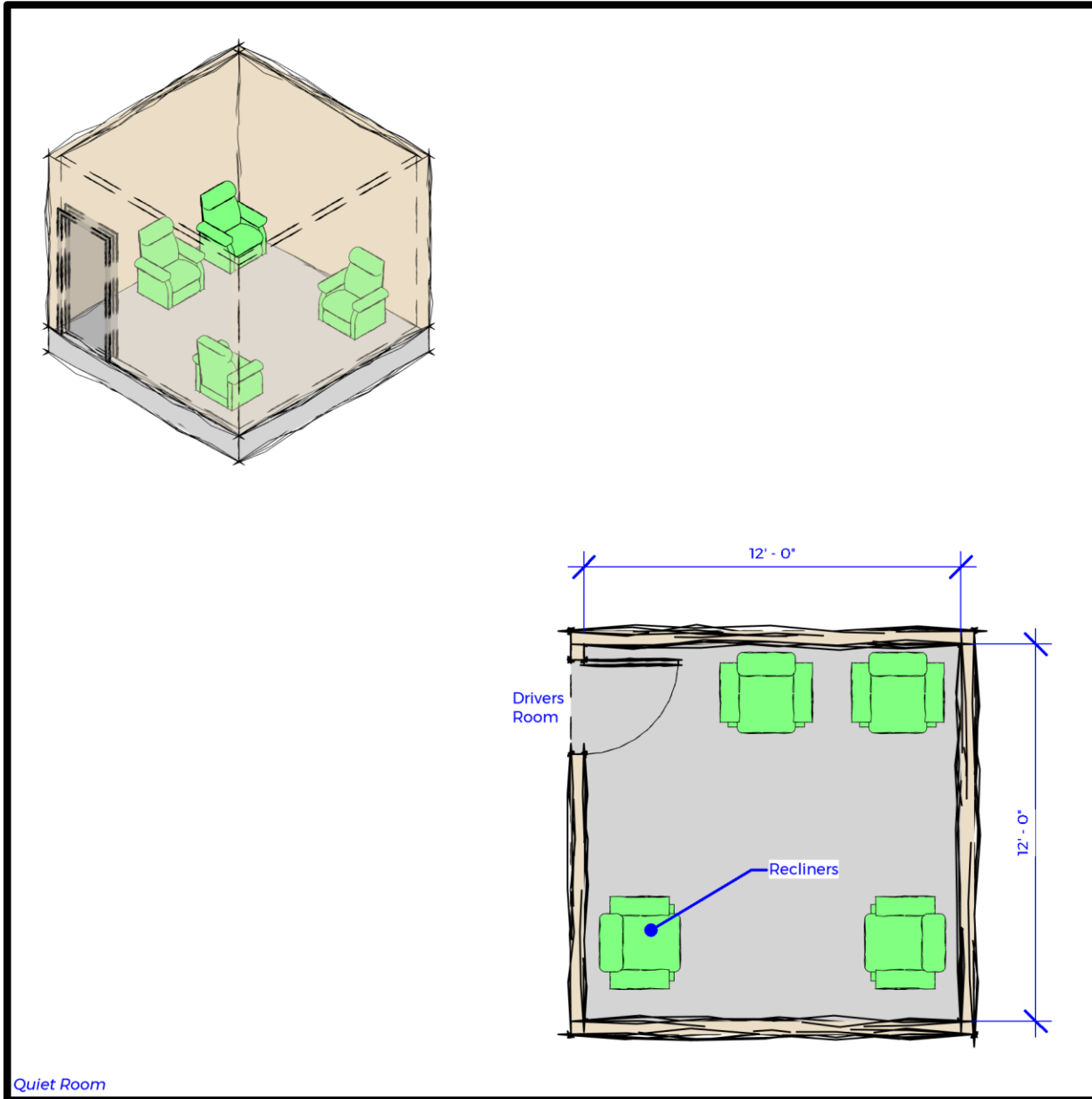

### Function

- Enclosed area for Driver use, before, between, and after shifts.

### Relationship to other Areas

- Near Drivers Room.

### Comments / Characteristics

- Furnishings: Refer to graphic on this page.
- Utility Requirements: Grounded electrical convenience outlets, telephone, air conditioned, and heated.
- Floor Finishes: Carpet Tile.
- Wall Finishes: Painted gypsum board.
- Ceiling Finishes: Acoustical tile ceiling.
- Lighting: Office Light Fixture Dimmable. Lighting design shall have the ability to dim. Refer to Chapter 4 for foot candle and fixture requirements. Task lighting provided at each recliner for reading without disturbing people in adjacent recliners. Provide floor lighting to keep light levels down.
- Acoustically isolated from surrounding spaces.
- Door to have narrow lite for visibility inside room.

Quiet Room

## LACTATION / SICK ROOM

(OPERATIONS)

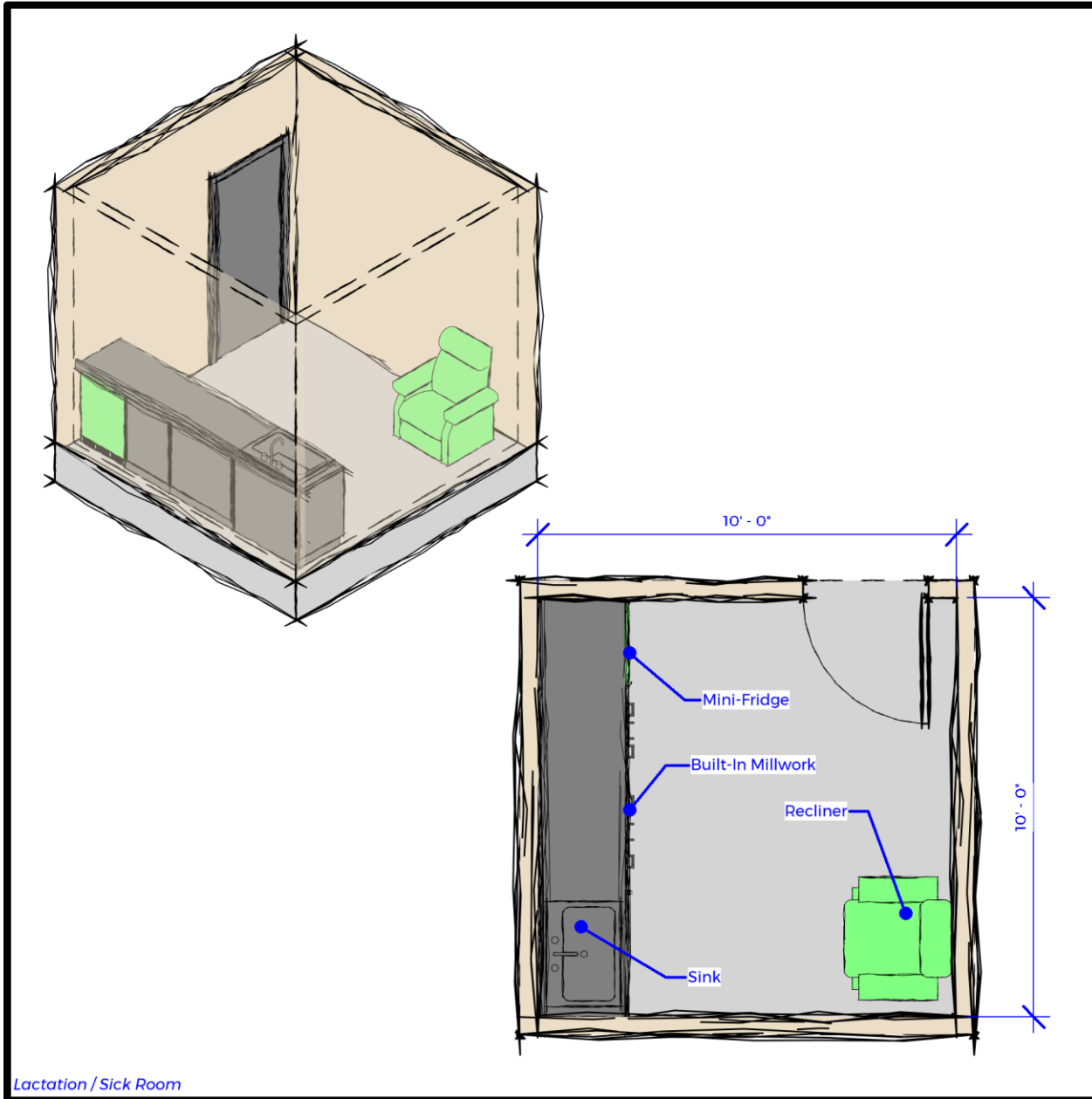

Lactation / Sick Room

### Function

- Enclosed private room for use of lactating mothers or sick personnel.

### Relationship to other Areas

- Adjacent to Drivers Room.

### Comments / Characteristics

- Furnishings: Refer to graphic on this page.
- Utility Requirements: Grounded electrical convenience outlets, telephone, air conditioned, and heated.
- Floor Finishes: Resilient flooring.
- Wall Finishes: Painted gypsum board.
- Ceiling Finishes: Acoustical tile ceiling.
- Lighting: Office Light Fixture Dimmable. Lighting design shall have the ability to dim. Refer to Chapter 4 for foot candle and fixture requirements.
- Acoustically isolated from surrounding spaces.



## UNISEX TOILET / SHOWER / DRUG TEST ROOM

(OPERATIONS)

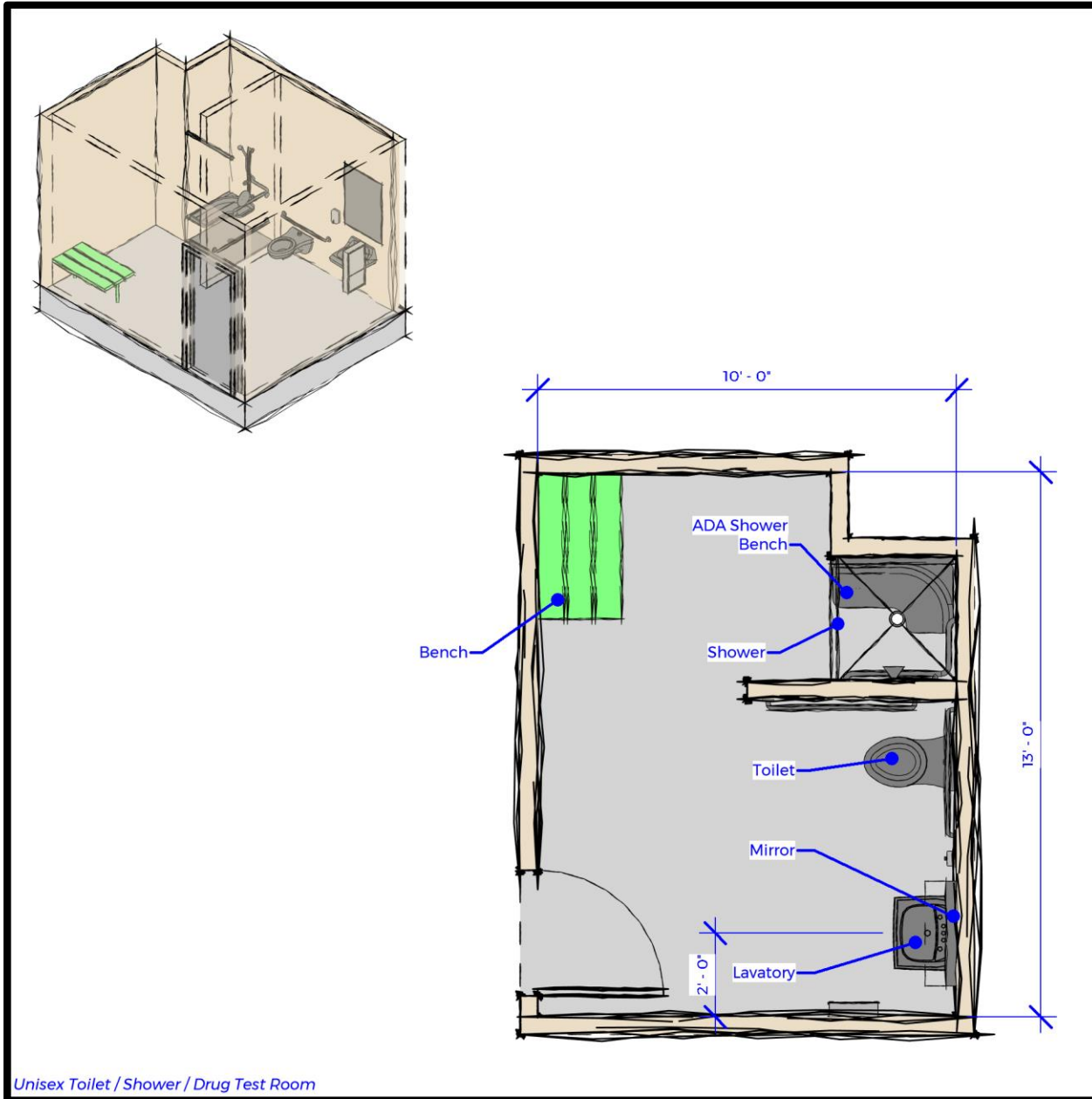

### Function

- Unisex restroom and shower facilities for Operations staff and for drug testing.

### Relationship to other Areas

- Adjacent to Drivers Room.

### Comments / Characteristics

- Furnishings: Refer to graphic on this page.
- Utility requirements: Grounded electrical convenience outlets, intercom/paging system, air conditioned, ventilated, and heated. Provide water cut-off valves on outside of room to allow drug testing monitor to turn off water to room and fixtures.
- Floor Finishes: Porcelain tile.
- Wall Finishes: Paint or porcelain tile on gypsum board.
- Ceiling Finishes: Paint gypsum board.
- Lighting: Wet location sealed fixtures and indirect light over mirror. Refer to Chapter 4 for foot candle and fixture requirements.

## MEN'S RESTROOM

(OPERATIONS)

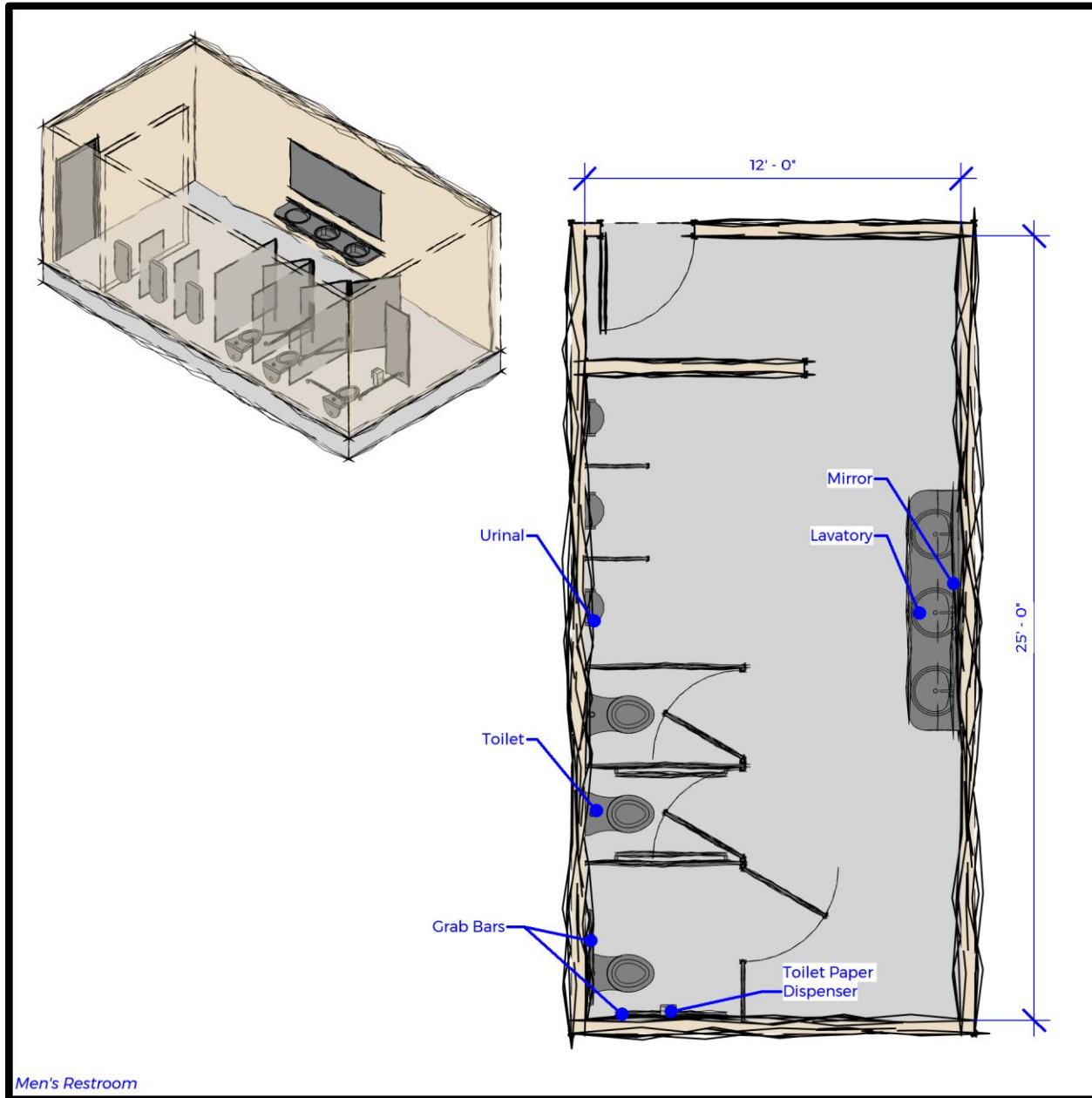

### Function

- Restroom facility for male drivers.

### Relationship to other Areas

- Adjacent to Drivers Room.

### Comments / Characteristics

- Furnishings: Refer to graphic on this page.
- Utility Requirements: Grounded electrical convenience outlets, intercom/paging system, air conditioned, ventilated, and heated.
- Floor Finishes: Porcelain tile.
- Wall Finishes: Painted gypsum board with porcelain tile on cement backer board at wet wall locations behind and a minimum of 3 feet to the sides of fixtures.
- Ceiling Finishes: Acoustical ceiling where appropriate.
- Lighting: Wet location sealed fixtures and indirect light over mirrors. Refer to Chapter 4 for foot candle and lighting requirements.



## WOMEN'S RESTROOM

(OPERATIONS)

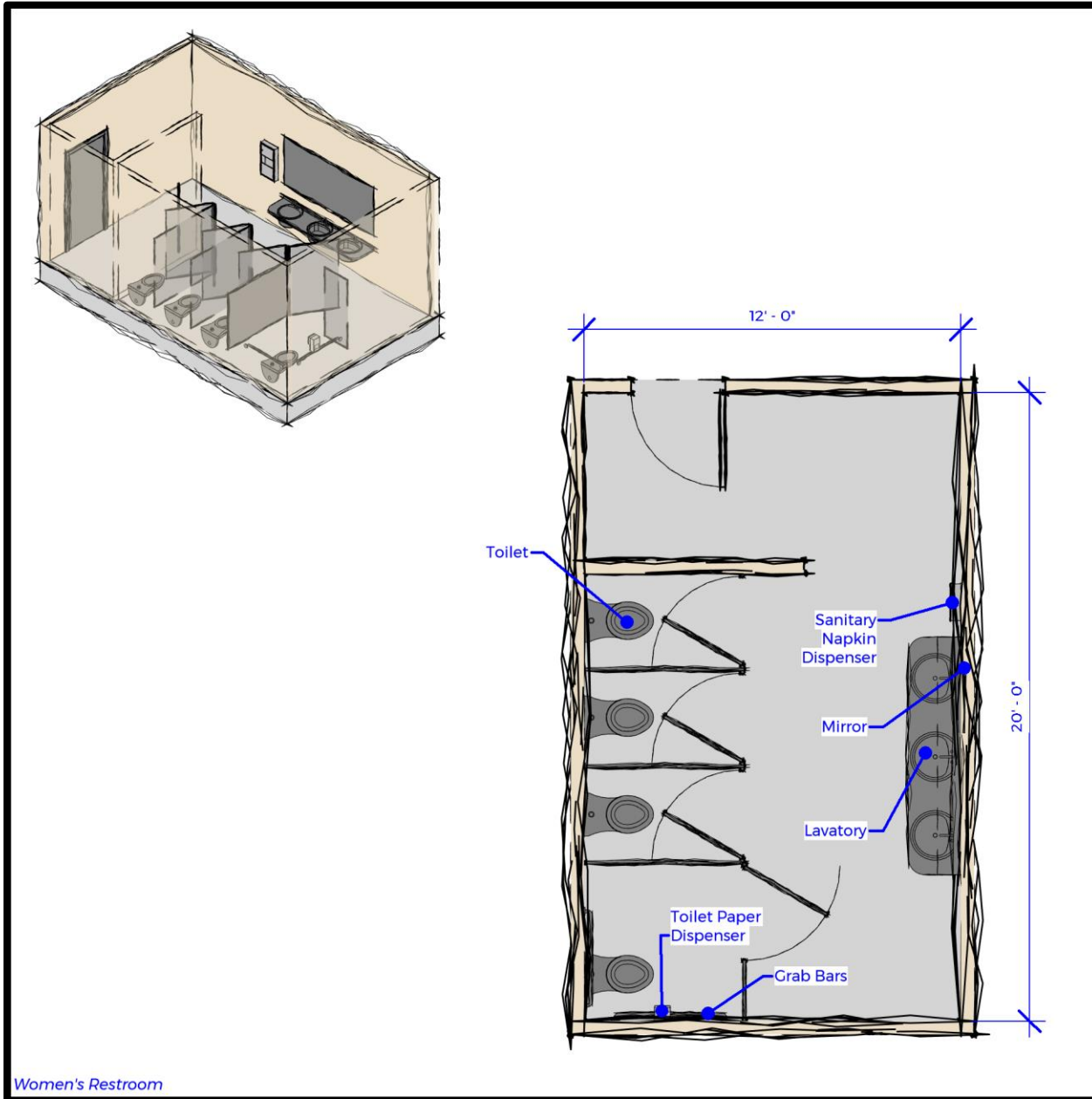

### Function

- Restroom facility for female drivers.

### Relationship to other Areas

- Adjacent to Drivers Room.

### Comments / Characteristics

- Furnishings: Refer to graphic on this page.
- Utility Requirements: Grounded electrical convenience outlets, intercom/paging system, air conditioned, ventilated, and heated.
- Floor Finishes: Porcelain tile.
- Wall Finishes: Painted gypsum board with porcelain tile on cement backer board at wet wall locations behind and a minimum of 3 feet to the sides of fixtures.
- Ceiling Finishes: Acoustical ceiling where appropriate.
- Lighting: Wet location sealed fixtures and indirect light over mirrors. Refer to Chapter 4 for foot candle and lighting requirements.

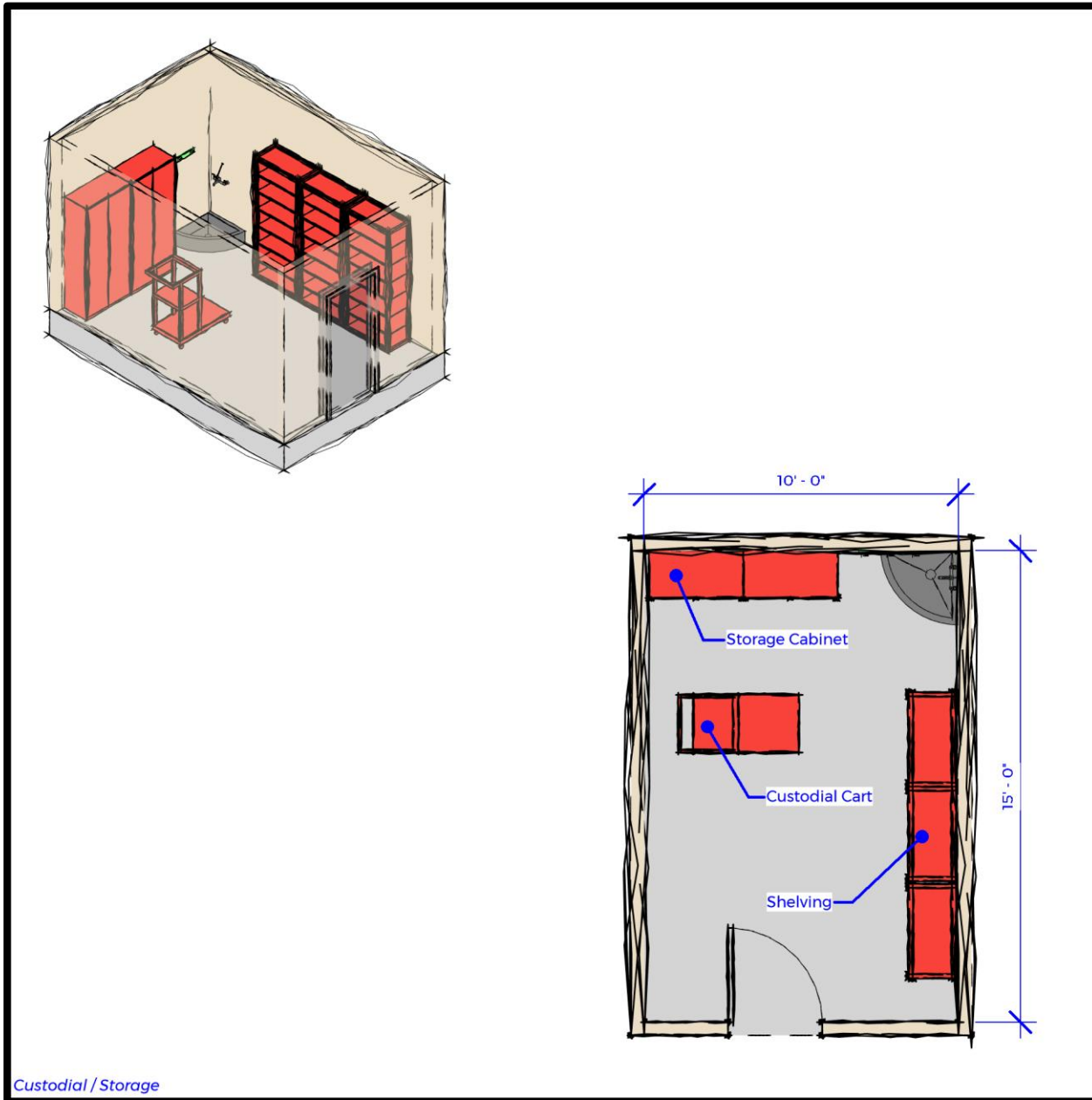

Custodial / Storage

**Function**

- Enclosed area for storage of janitorial supplies and cleaning equipment.

**Relationship to other Areas**

- Near Restrooms.

**Comments / Characteristics**

- Furnishings: Refer to graphic on this page.
- Floor mounted mop sink with wall mounted faucet with bucket hook.
- Utility Requirements: Grounded electrical convenience outlets, ventilated, and heated.
- Floor Finishes: Porcelain tile or sealed concrete.
- Wall Finishes: Porcelain tile on gypsum board and/or concrete block.
- Ceiling Finishes: Acoustical ceiling where appropriate.
- Lighting: Service Light Fixture – Utility spaces. Refer to Chapter 4 for foot candle and fixture requirements.

## Mechanical

*(Operations)*

### FUNCTION

- Enclosed separately secured space designated for mechanical building support systems.

### RELATIONSHIP TO OTHER AREAS

- Adjacent to Electrical Room

### COMMENTS / CHARACTERISTICS

- Provide double doors as needed for access to equipment.
- Furnishings: Mechanical equipment.
- Utility Requirements: As required by equipment.
- Floor Finishes: Sealed concrete.
- Wall Finishes: Painted gypsum board and/or concrete block.
- Ceiling Finishes: Painted exposed structure.
- Lighting: Service Light Fixture – Utility spaces. Refer to Chapter 4 for foot candle and fixture requirements.

## Electrical

*(Operations)*

### FUNCTION

- Designated space for electrical building support equipment.

### RELATIONSHIP TO OTHER AREAS

- Adjacent to Mechanical Room.

### COMMENTS / CHARACTERISTICS

- Provide double doors as needed for access to equipment.
- Furnishings: Electrical equipment.
- Utility Requirements: As required by equipment.
- Floor Finishes: Sealed concrete.
- Wall Finishes: Painted gypsum board and/or concrete block.
- Ceiling Finishes: Painted exposed structure.
- Lighting: Service Light Fixture – Utility spaces. Refer to Chapter 4 for foot candle and fixture requirements.

**THIS PAGE INTENTIONALLY LEFT BLANK**

## MAINTENANCE

### FUNCTIONAL RELATIONSHIP DIAGRAM

The relationships between the spaces within this section are shown below. The design should accommodate these relationships in order to maximize operational efficiency. This diagram is not meant to be a floor plan, It serves only as a representational relationship diagram.

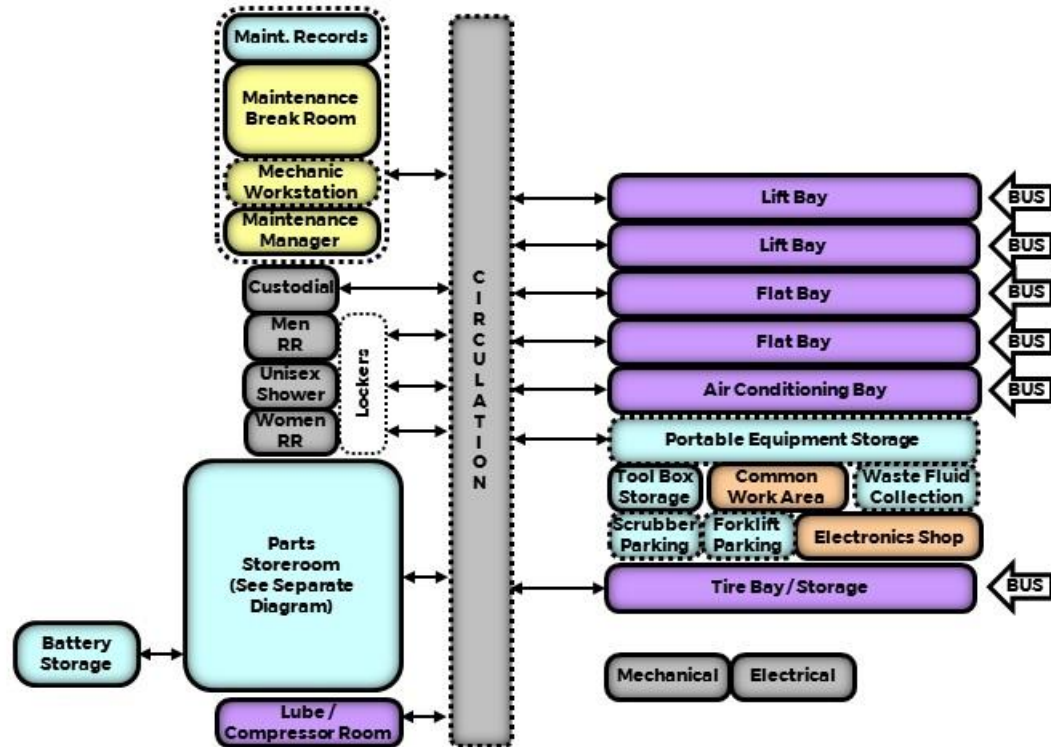

### FUNCTIONAL AREA MODULES

Each functional area within this section has been individually defined as a module. Each module has information regarding the function of the space, relationships to other areas and other information received during interviews with Yuba-Sutter Transit staff.

## Maintenance Manager

*(Maintenance)*

See Typical Module 2

### FUNCTION

- Enclosed private office for the Maintenance Manager.

### RELATIONSHIP TO OTHER AREAS

- Adjacent to Mechanic Workstation.
- View of Repair Bays.

### COMMENTS / CHARACTERISTICS

- Furnishings: Refer to module graphic.
- Utility Requirements: Grounded electrical convenience outlets, telephone, intercom/paging system, conduit for network computer system, air conditioned, and heated.
- Floor Finishes: Resilient flooring.
- Wall Finishes: Painted gypsum board and/or concrete block.
- Ceiling Finish: Acoustical tile ceiling.
- Lighting: Office Light Fixture. Refer to Chapter 4 for foot candle and fixture requirements.

## MECHANIC WORKSTATION

(MAINTENANCE)

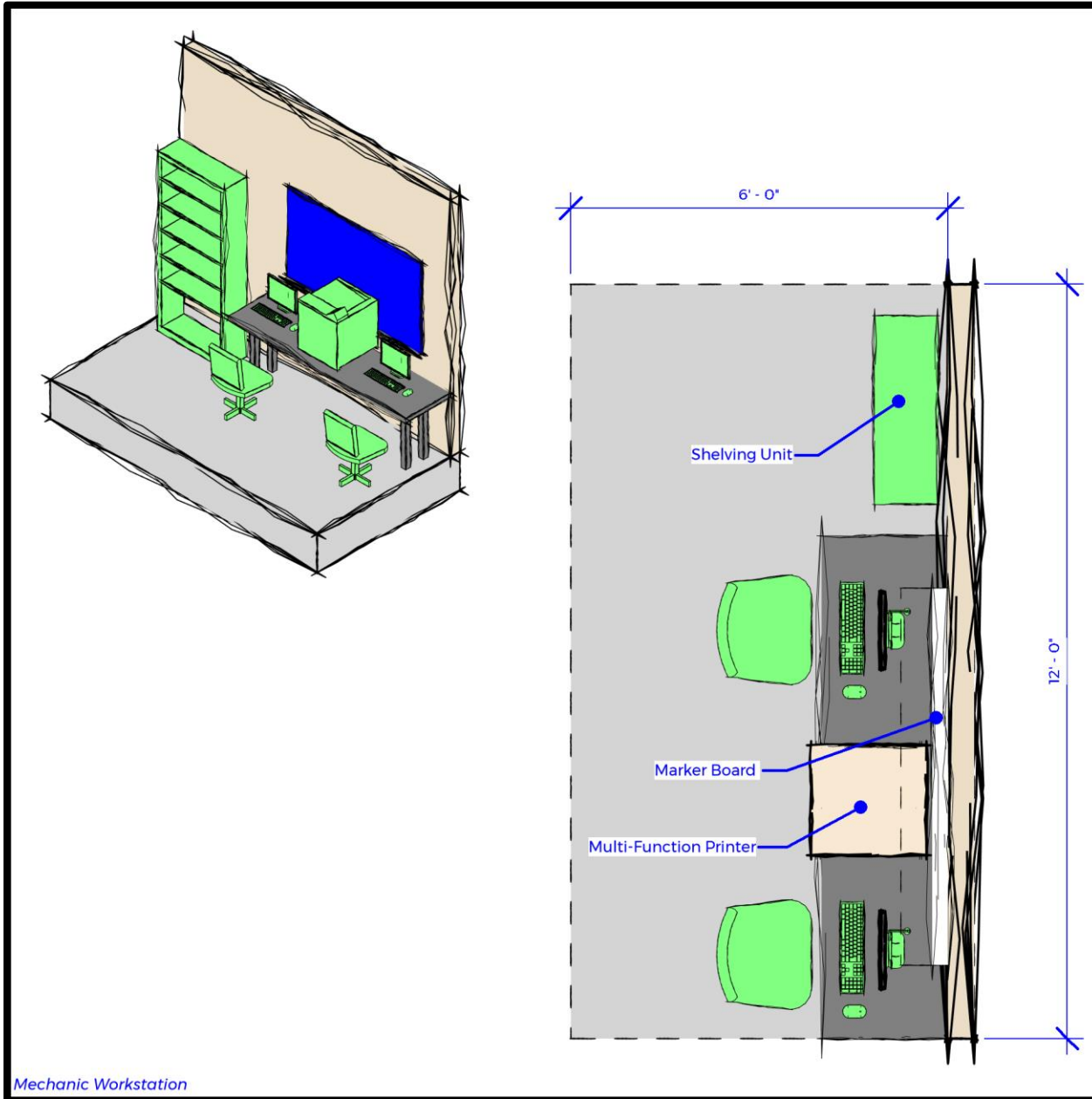

Mechanic Workstation

### Function

- Open workstation area for mechanics to perform computer and paperwork.

### Relationship to other Areas

- Adjacent to Maintenance Manager and Repair Bays.

### Comments / Characteristics

- Furnishings: Refer to graphic on this page.
- Utility Requirements: Grounded electrical convenience outlets, ventilated, and heated.
- Floor Finishes: Soil, grease, and water resistant concrete, with integral non-metallic hardener, and clear epoxy sealer. Provide slip resistant finish.
- Wall Finishes: Soil and grease resistant. Epoxy painted to 8'-0" AFF.
- Ceiling Finishes: Painted exposed structure.
- Lighting: Office Light Fixture. Refer to Chapter 4 for foot candle and fixture requirements.

## MAINTENANCE BREAK ROOM

(MAINTENANCE)

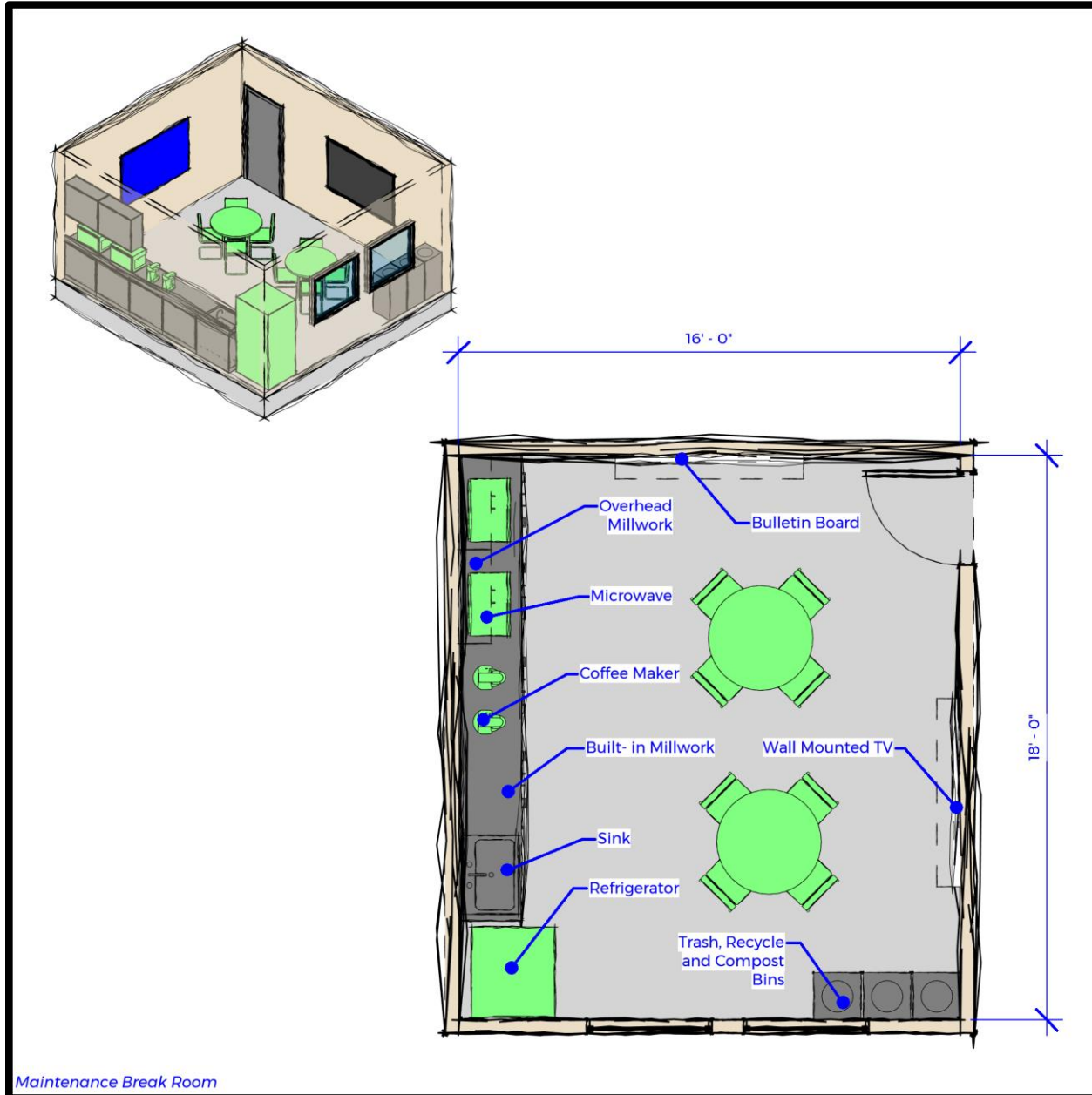

### Function

- Open area for Maintenance personnel breaks.

### Relationship to other Areas

- Adjacent to Maintenance Office Spaces.
- Convenient access from Repair Bays.

### Comments / Characteristics

- Furnishings: Refer to graphic on this page.
- Utility Requirements: Grounded electrical convenience outlets, telephone, intercom/paging system, air conditioned, and heated. Floor drain near vending machines.
- Window to outside if possible.
- Floor Finishes: Resilient flooring.
- Wall Finishes: Painted gypsum board.
- Ceiling Finishes: Acoustical tile ceiling.
- Lighting: Office Light Fixture - common area. Refer to Chapter 4 for foot candle and fixture requirements.



## MEN'S RESTROOM

(MAINTENANCE)

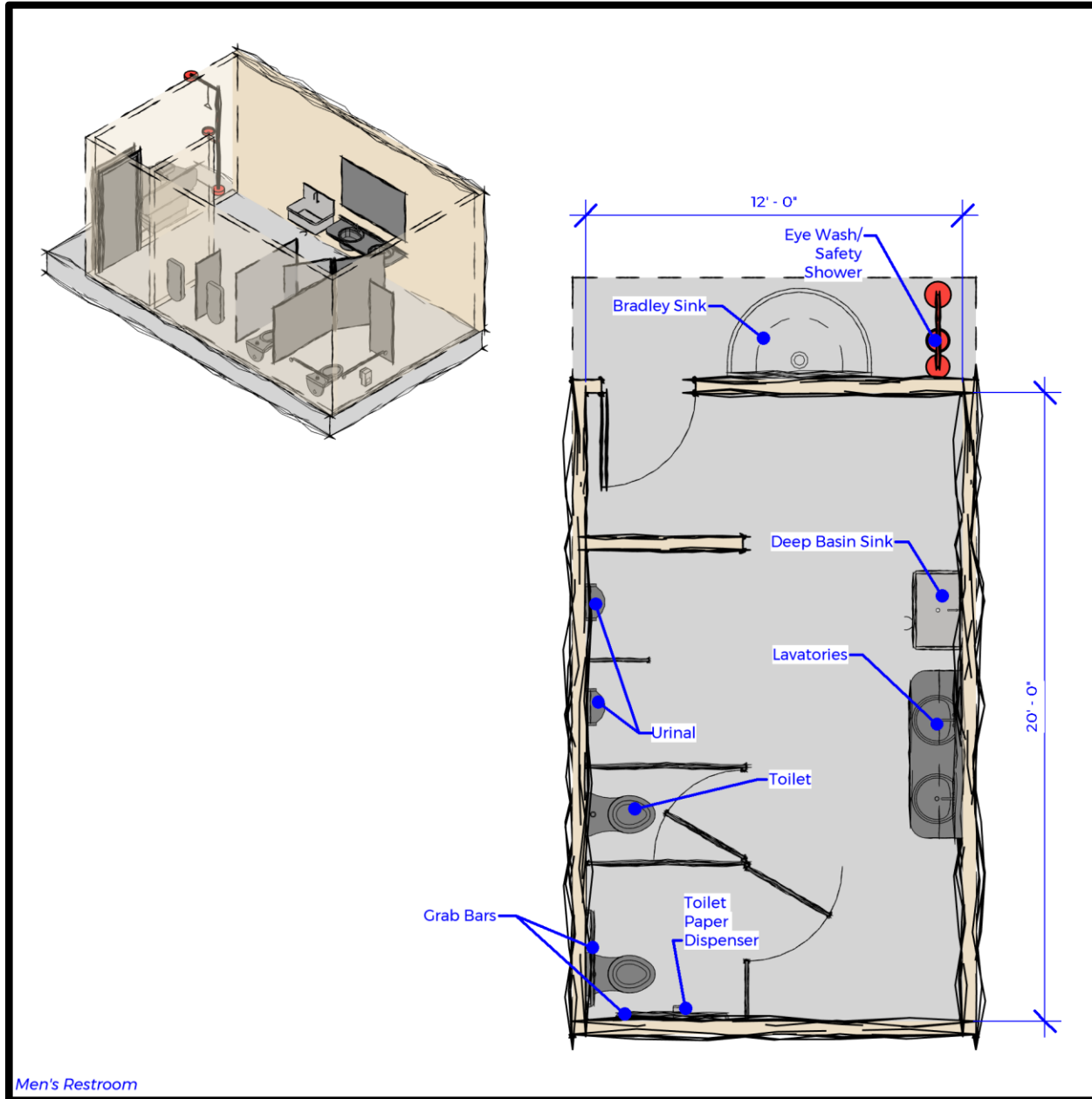

Men's Restroom

### Function

- Restroom facility for male mechanics.

### Relationship to other Areas

- Adjacent to Maintenance Break Room.
- Convenient access from Repair Bays.

### Comments / Characteristics

- Furnishings: Refer to graphic on this page.
- Utility Requirements: Grounded electrical convenience outlets, intercom/paging system, air conditioned, ventilated, and heated.
- Floor Finishes: Porcelain tile.
- Wall Finishes: Painted gypsum board with porcelain tile on gypsum board and wet areas.
- Ceiling Finishes: Acoustical ceiling where appropriate.
- Lighting: Wet location sealed fixtures and indirect light over mirrors. Refer to Chapter 4 for foot candle and lighting requirements.

## WOMEN'S RESTROOM

(MAINTENANCE)

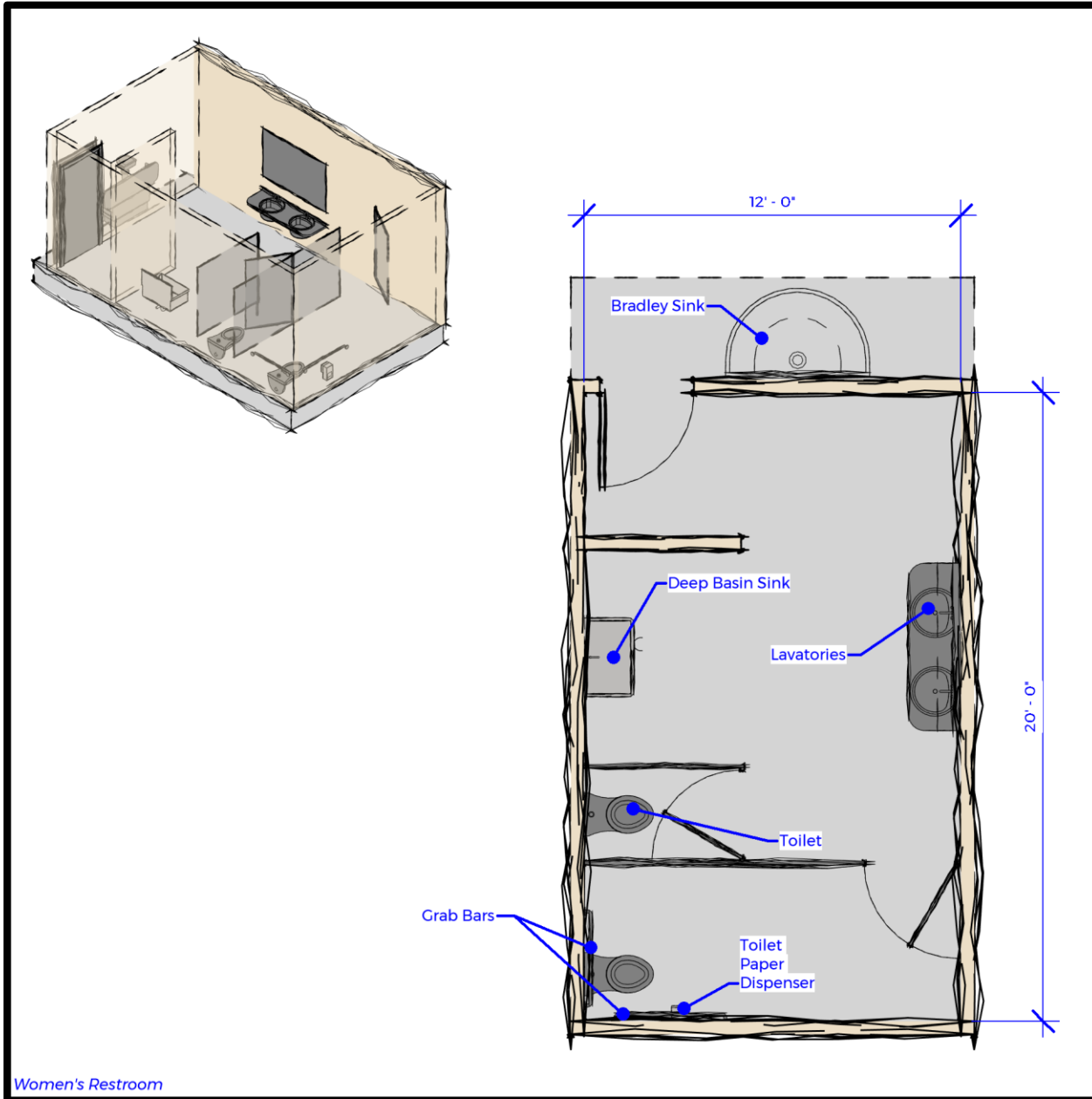

Women's Restroom

### Function

- Restroom facility for male mechanics.

### Relationship to other Areas

- Adjacent to Maintenance Break Room.
- Convenient access from Repair Bays.

### Comments / Characteristics

- Furnishings: Refer to graphic on this page.
- Utility Requirements: Grounded electrical convenience outlets, intercom/paging system, air conditioned, ventilated, and heated.
- Floor Finishes: Porcelain tile.
- Wall Finishes: Painted gypsum board with porcelain tile on gypsum board and wet areas.
- Ceiling Finishes: Acoustical ceiling where appropriate.
- Lighting: Wet location sealed fixtures and indirect light over mirrors. Refer to Chapter 4 for foot candle and lighting requirements.

## UNISEX SHOWER

(MAINTENANCE)

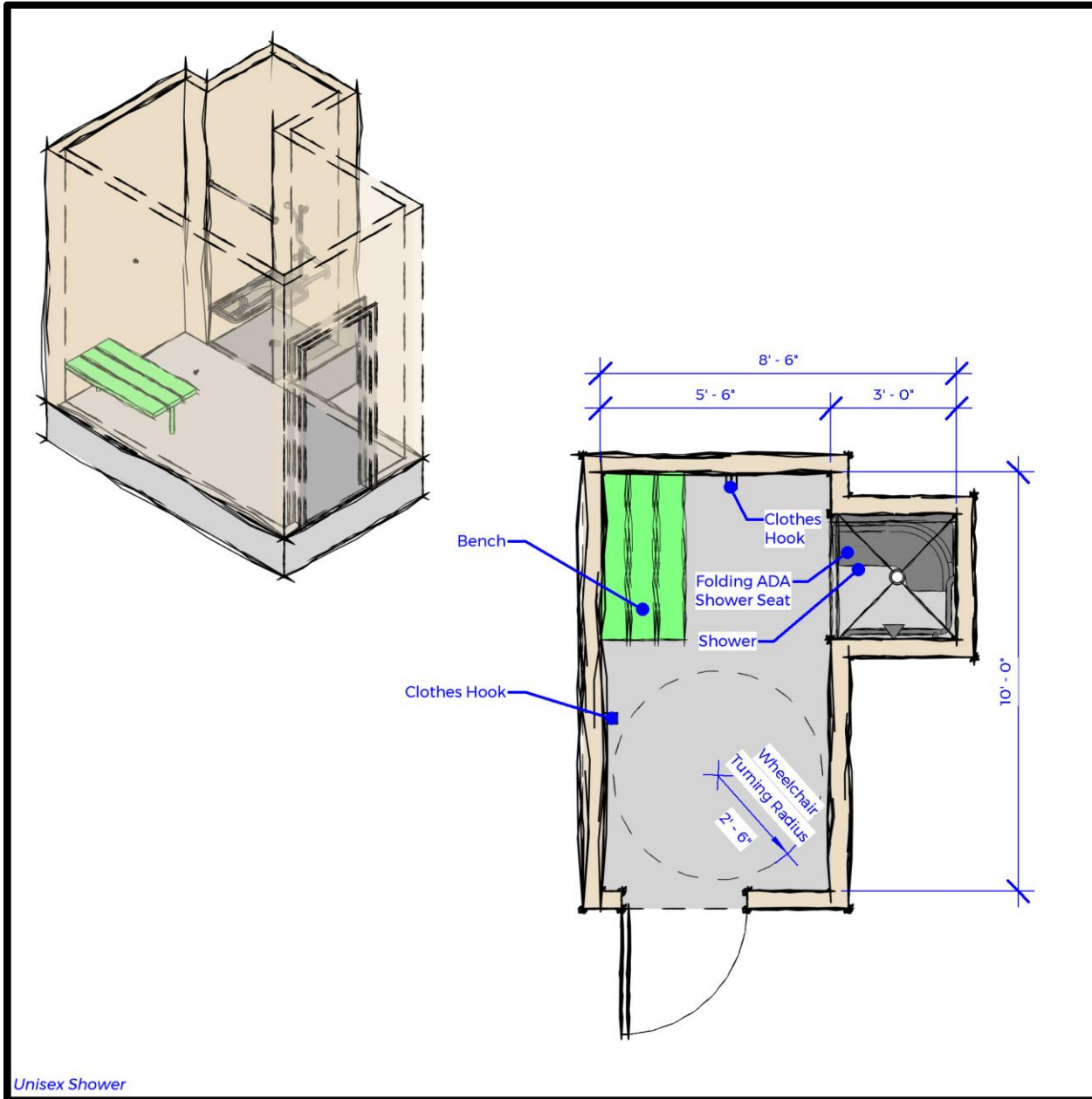

### Function

- Unisex shower facility for male and female mechanics.

### Relationship to other Areas

- Adjacent to Restrooms.

### Comments / Characteristics

- Furnishings: Refer to graphic on this page.
- Utility Requirements: Grounded electrical convenience outlets, intercom/paging system, air conditioned, ventilated, and heated.
- Floor Finishes: Porcelain tile.
- Wall Finishes: Porcelain tile on gypsum board and/or concrete block.
- Ceiling Finishes: Acoustical ceiling or plaster ceiling.
- Lighting: Service Light Fixture. Refer to Chapter 4 for foot candle and fixture requirements.

## LOCKERS

(MAINTENANCE)

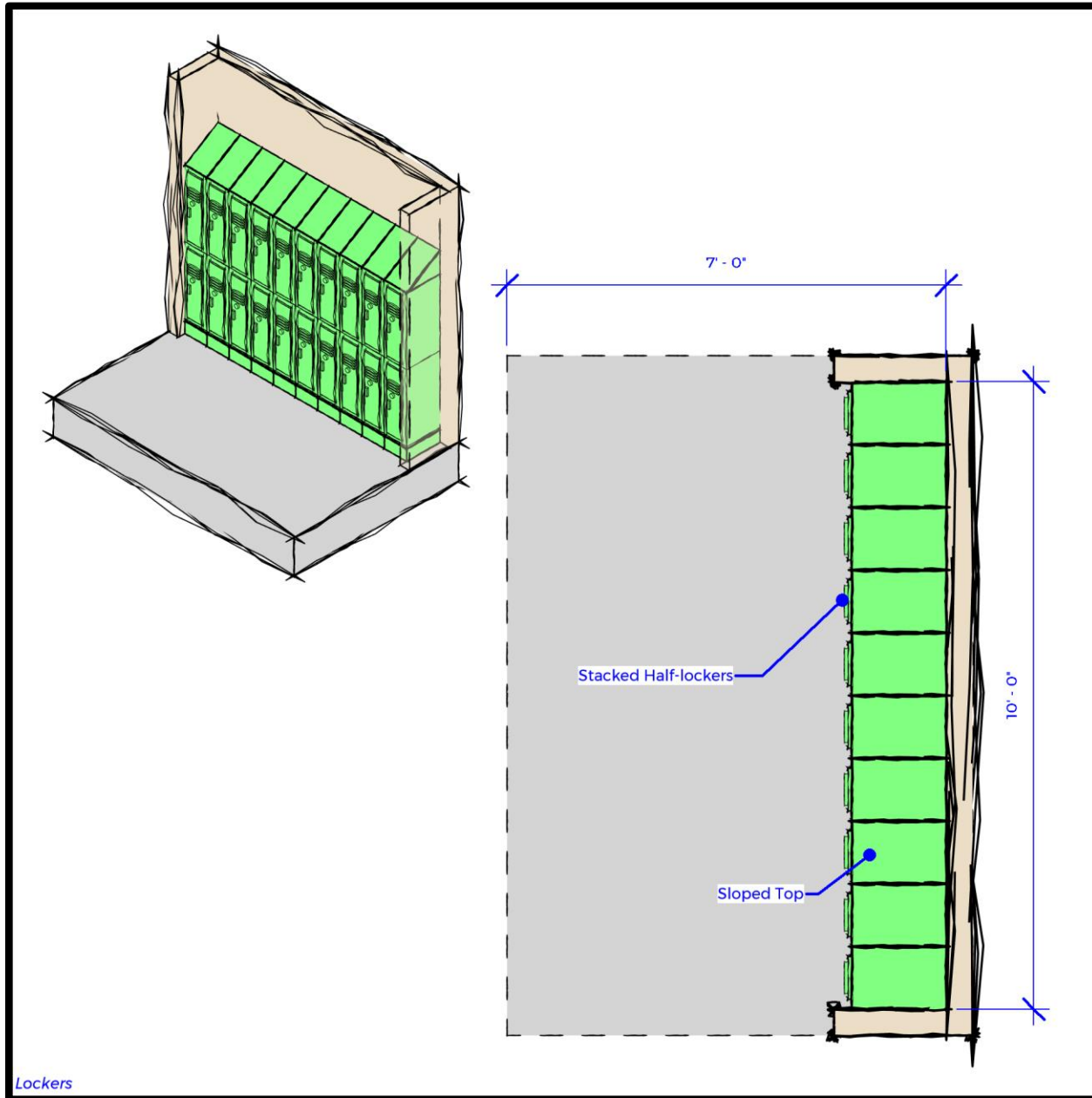

### Function

- Open alcove area to accommodate male and female mechanics.
- Intended for storage of personal items, not intended for full dressing/undressing.

### Relationship to other Areas

- Adjacent to Restrooms.
- Near Repair Bays.

### Comments / Characteristics

- Furnishings: 20 half height stacked lockers and bench.
- Utility Requirements: Ground electrical convenience outlets, intercom/paging system, air conditioned, ventilated, and heated.
- Floor Finishes: Porcelain tile or resilient flooring.
- Wall Finishes: Painted gypsum.
- Ceiling Finishes: Acoustical ceiling.
- Lighting: Office Light Fixture. Refer to Chapter 4 for foot candle and fixture requirements.

## MAINTENANCE RECORDS

(MAINTENANCE)

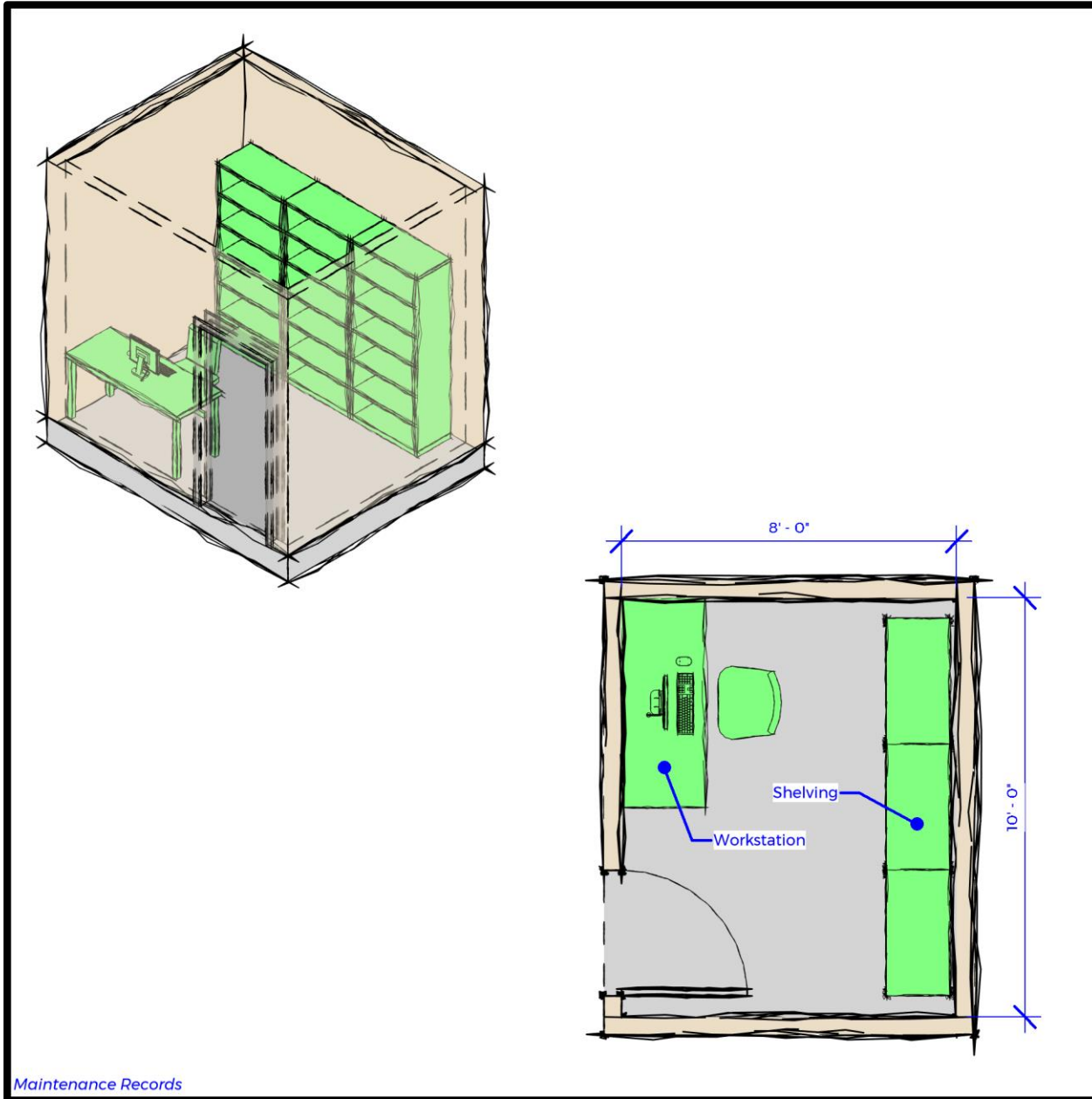

### Function

- Enclosed area for maintenance record storage.

### Relationship to other Areas

- Adjacent to Maintenance Office Spaces.
- Convenient access from Repair Bays.

### Comments / Characteristics

- Furnishings: Refer to graphic on this page. Three shelving units to accommodate approximately 42 file storage boxes or boxes and manuals.
- Utility Requirements: Grounded electrical convenience outlet near door, air conditioned, and heated.
- Floor Finishes: Resilient flooring.
- Wall Finishes: Painted gypsum board.
- Ceiling Finishes: Acoustical ceiling.
- Lighting: Office Light Fixture. Refer to Chapter 4 for foot candle and fixture requirements.

## CUSTODIAL

(MAINTENANCE)

### Function

- Enclosed area for storage of janitorial and cleaning supplies.

### Relationship to other Areas

- Near Restrooms.

### Comments / Characteristics

- Furnishings: Refer to graphic on this page.
- Floor finishes: Porcelain tile or sealed concrete.
- Wall finishes: Porcelain tile on gypsum board and/or concrete block.
- Ceiling finishes: Acoustical ceiling where appropriate.
- Lighting: Service Light Fixture – Utility spaces. Refer to Chapter 4 for foot candle and fixture requirements.

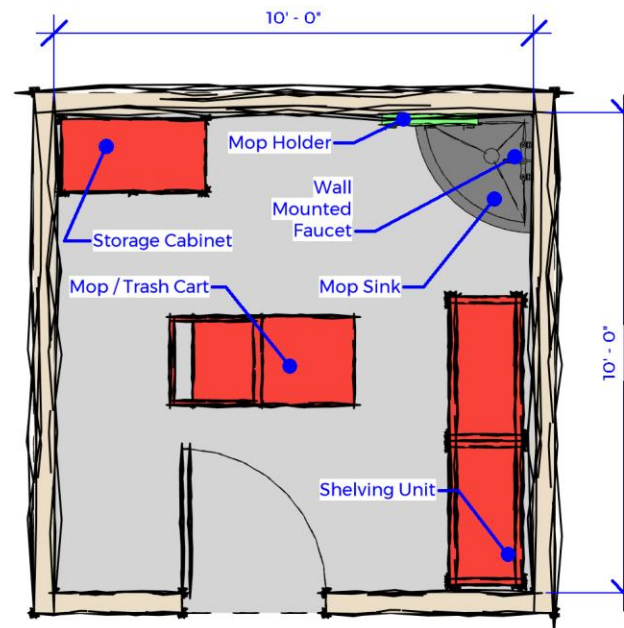
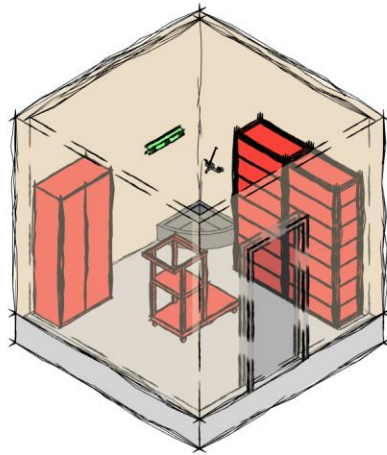

Custodial

**THIS PAGE INTENTIONALLY LEFT BLANK**



Lift Bay (45 ft Bus)

(Maintenance)

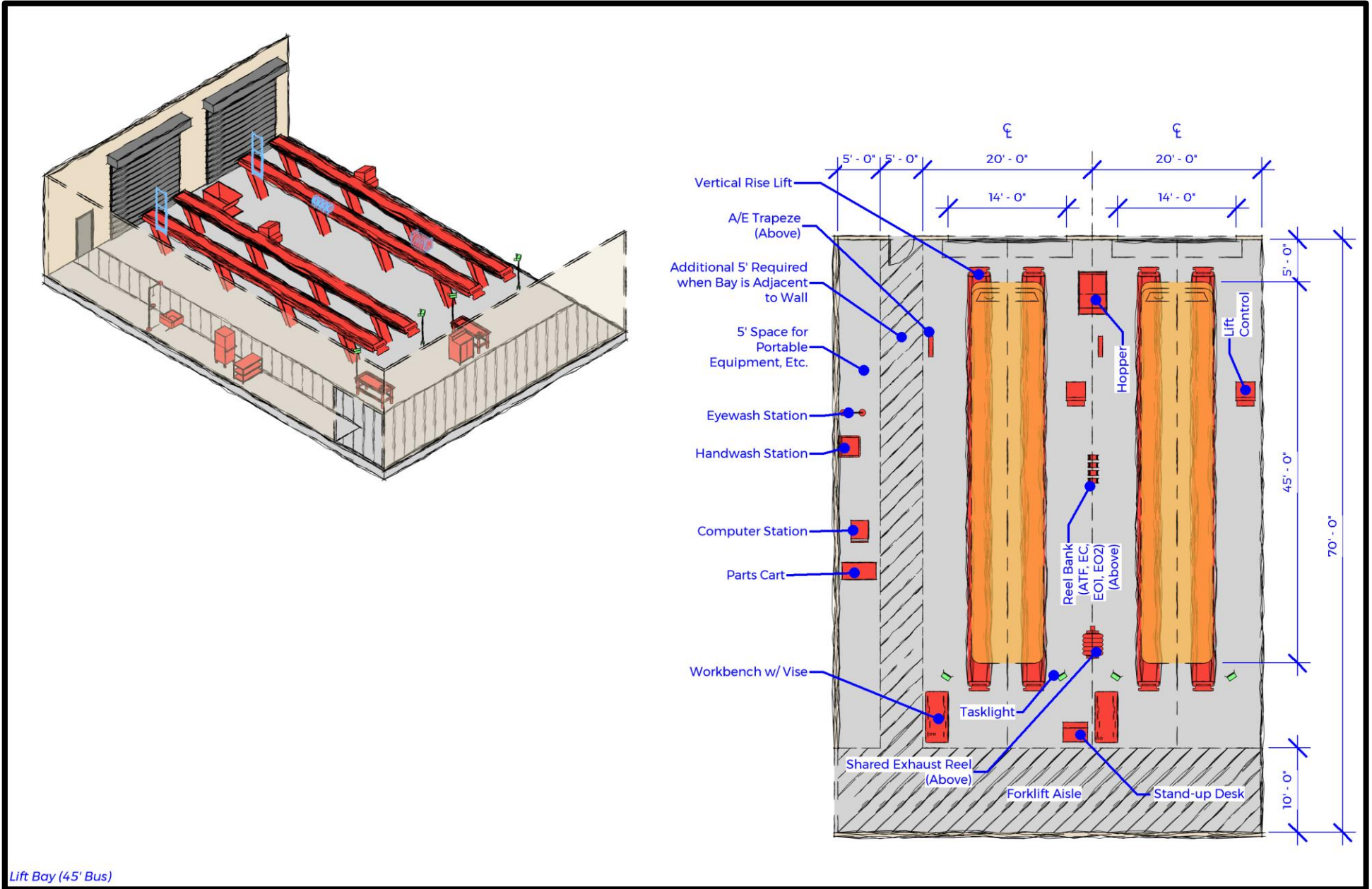

Lift Bay (45' Bus)



## FUNCTION

- Designated maintenance bay for scheduled or unscheduled preventive maintenance, inspection tire servicing, and major repairs on 25 - 45 ft transit buses and non-revenue vehicles.

## RELATIONSHIP TO OTHER AREAS

- Adjacent to Repair Bays, Equipment Storage, and Tool Box Storage.
- Convenient access to Maintenance Break Room, Restrooms, Shower, and Lockers.
- Near Common Work Area.

## CRITICAL DIMENSIONS

- 19'-0" vertical clearance.
- 20'-0" wide by 60'-0" long.

## COMMENTS / CHARACTERISTICS

- Furnishings: Refer to graphics on previous page.
- Forklift access.

## ARCHITECTURAL

- Finishes
  - ~ Floor: Soil, grease, and water resistant concrete, with integral non-metallic hardener, and clear epoxy sealer. Provide slip resistant finish.
  - ~ Walls: Soil and grease resistant. Epoxy painted to 8'-0" AFF.
  - ~ Ceiling: Painted exposed structure.
- Doors
  - ~ Personnel doors to meet applicable codes and exiting requirements.
  - ~ Exterior sectional overhead door: 14' x 14' motor operated with interior push button controls, and lockout on exterior.
- Bollards on interior and exterior at jambs of overhead door (2 per door).

## STRUCTURAL

- Control joints in floor slab at adequate spacing.
- Structural columns must not be located at the sides between bays.
- Bay to have level floor with warps to slope to drain at intersection to interior drive aisle.

- Structure as needed to support equipment.

## MECHANICAL

- Overhead vehicle exhaust system with 8" exhaust hose on a motorized reel with integral exhaust fan and automatic fan switch at rear of vehicle position shared between bays..
- Heating system must be compatible with possible future use of alternative fueled vehicles.
- Ventilation as required by codes to prevent accumulation of explosive mixtures.
- General ventilation as required by codes.
- As required by equipment.

## ELECTRICAL

- Lighting
  - ~ Maximize day lighting.
  - ~ High bay LED fixture. Refer to chapter 4 for foot candle lighting requirements.
- Power
  - ~ Air/electric drop trapeze mounted quad receptacle, 120VAC, 20A, GFI protected between bays.
  - ~ General purpose duplex receptacles, 120VAC, 20A, GFI protected, on walls, columns, and between overhead doors at 3'-6" AFF.
  - ~ As required by equipment.
- Communications
  - ~ Paging/intercom system speakers in bay.
  - ~ Data port in each repair bay at columns and/or on air/electric trapeze at workbench locations in bay.

## PLUMBING

- Trench drain just inside overhead doors.
- Overhead Lube reel banks with ATF, EC, EO1, and EO2, at rear of vehicle position (reel banks shared with adjacent bays). Overhead reel bank for WWF at front of vehicle position (reel banks shared with adjacent bays).
- 3/4" water hose bib with standard faucet between bay doors at 4'-0" AFF (1 per 3 bays).
- Compressed air line with cut-off valve, filter, regulator with gauge, lubricator, cleanout valve, and quick disconnects at 4'-0" AFF (between bay doors) and on air/electric drop "trapeze" between bays at mid-bay (shared with adjacent bays).

Provide disconnects for 1/2" and 1" impact tools at locations to be determined during detailed design.

- As required by equipment.

Flat Bay (45 ft Bus)

(Maintenance)

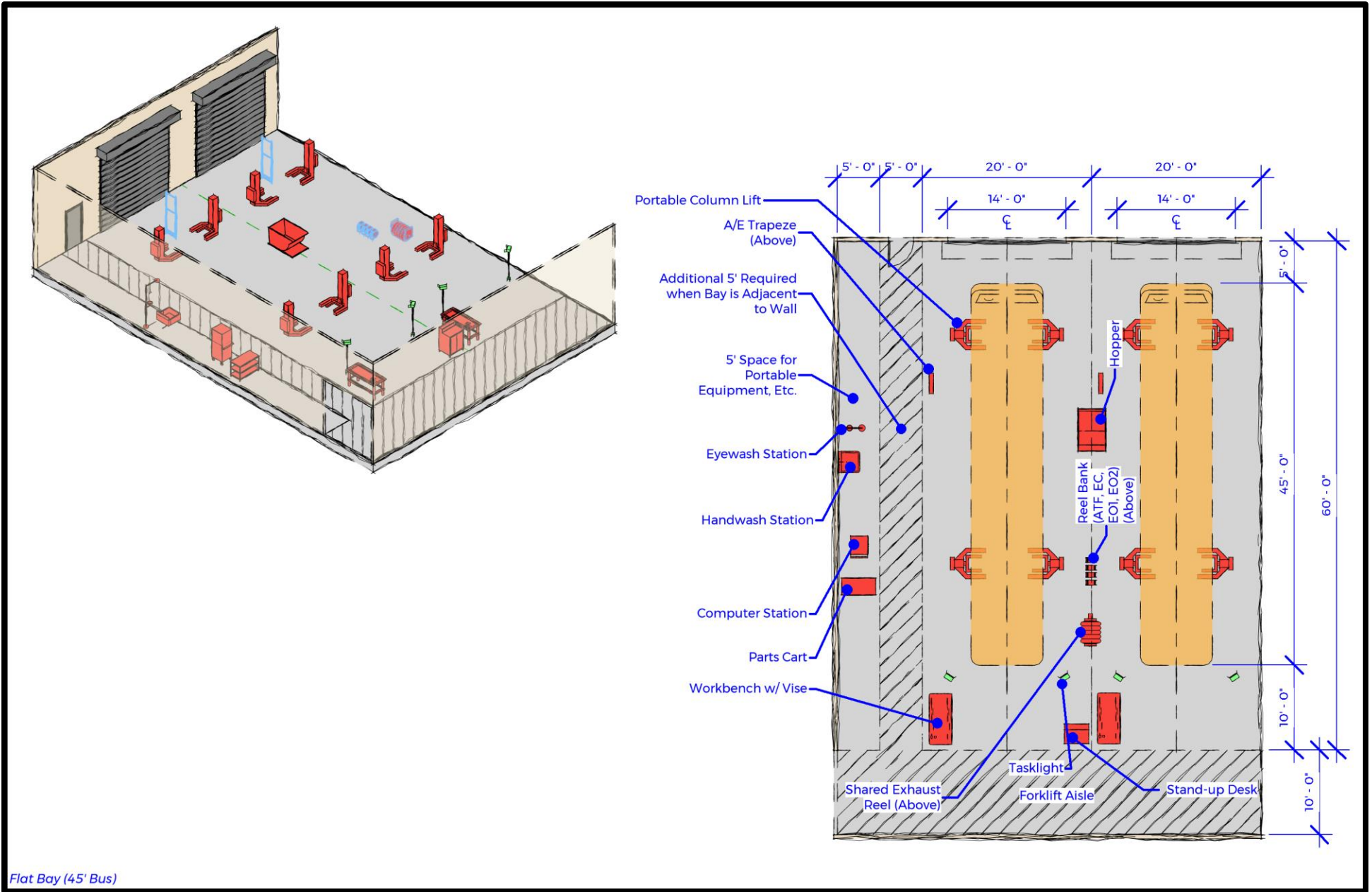

Flat Bay (45' Bus)

## FUNCTION

- Designated maintenance bay for scheduled or unscheduled preventive maintenance, inspection tire servicing, and major repairs on 25 – 45 ft transit buses and non-revenue vehicles.

## RELATIONSHIP TO OTHER AREAS

- Adjacent to Repair Bays, Equipment Storage, and Tool Box Storage.
- Convenient access to Maintenance Break Room, Restrooms, Shower, and Lockers.
- Near Common Work Area.

## CRITICAL DIMENSIONS

- 19'-0" vertical clearance.
- 20'-0" wide by 60'-0" long.

## COMMENTS / CHARACTERISTICS

- Furnishings: Refer to graphics on previous page.
- Forklift access.

## ARCHITECTURAL

- Finishes
  - ~ Floor: Soil, grease, and water resistant concrete, with integral non-metallic hardener, and clear epoxy sealer. Provide slip resistant finish.
  - ~ Walls: Soil and grease resistant. Epoxy painted to 8'-0" AFF.
  - ~ Ceiling: Painted exposed structure.
- Doors
  - ~ Personnel doors to meet applicable codes and exiting requirements.
  - ~ Exterior sectional overhead door: 14' x 14' motor operated with interior push button controls, and lockout on exterior.
- Bollards on interior and exterior at jambs of overhead door (2 per door).

## STRUCTURAL

- Control joints in floor slab at adequate spacing.
- Structural columns must not be located at the sides between bays.
- Bay to have level floor with warps to slope to drain at intersection to interior drive aisle.

- Structure as needed to support equipment.

## MECHANICAL

- Overhead vehicle exhaust system with 8" exhaust hose on a motorized reel with integral exhaust fan and automatic fan switch at rear of vehicle position shared between bays.
- Heating system must be compatible with possible future use of alternative fueled vehicles.
- Ventilation as required by codes to prevent accumulation of explosive mixtures.
- General ventilation as required by codes.
- As required by equipment.

## ELECTRICAL

- Lighting
  - ~ Maximize day lighting.
  - ~ High bay LED fixture. Refer to chapter 4 for foot candle lighting requirements.
- Power
  - ~ Air/electric drop trapeze mounted quad receptacle, 120VAC, 20A, GFI protected between bays.
  - ~ General purpose duplex receptacles, 120VAC, 20A, GFI protected, on walls, columns, and between overhead doors at 3'-6" AFF.
  - ~ As required by equipment.
- Communications
  - ~ Paging/intercom system speakers in bay.
  - ~ Data port in each repair bay at columns and/or on air/electric trapeze at workbench locations in bay.

## PLUMBING

- Trench drain just inside overhead doors.
- Overhead Lube reel banks with ATF, EC, EO1, and EO2, at rear of vehicle position (reel banks shared with adjacent bays). Overhead reel bank for WWF at front of vehicle position (reel banks shared with adjacent bays).
- 3/4" water hose bib with standard faucet between bay doors at 4'-0" AFF (1 per 3 bays).
- Compressed air line with cut-off valve, filter, regulator with gauge, lubricator, cleanout valve, and quick disconnects at 4'-0" AFF (between bay doors) and on air/electric drop "trapeze" between bays at mid-bay (shared with adjacent bays).

Provide disconnects for 1/2" and 1" impact tools at locations to be determined during detailed design.

- As required by equipment.

**Air Conditioning Bay (45 ft Bus)**

**(Maintenance)**

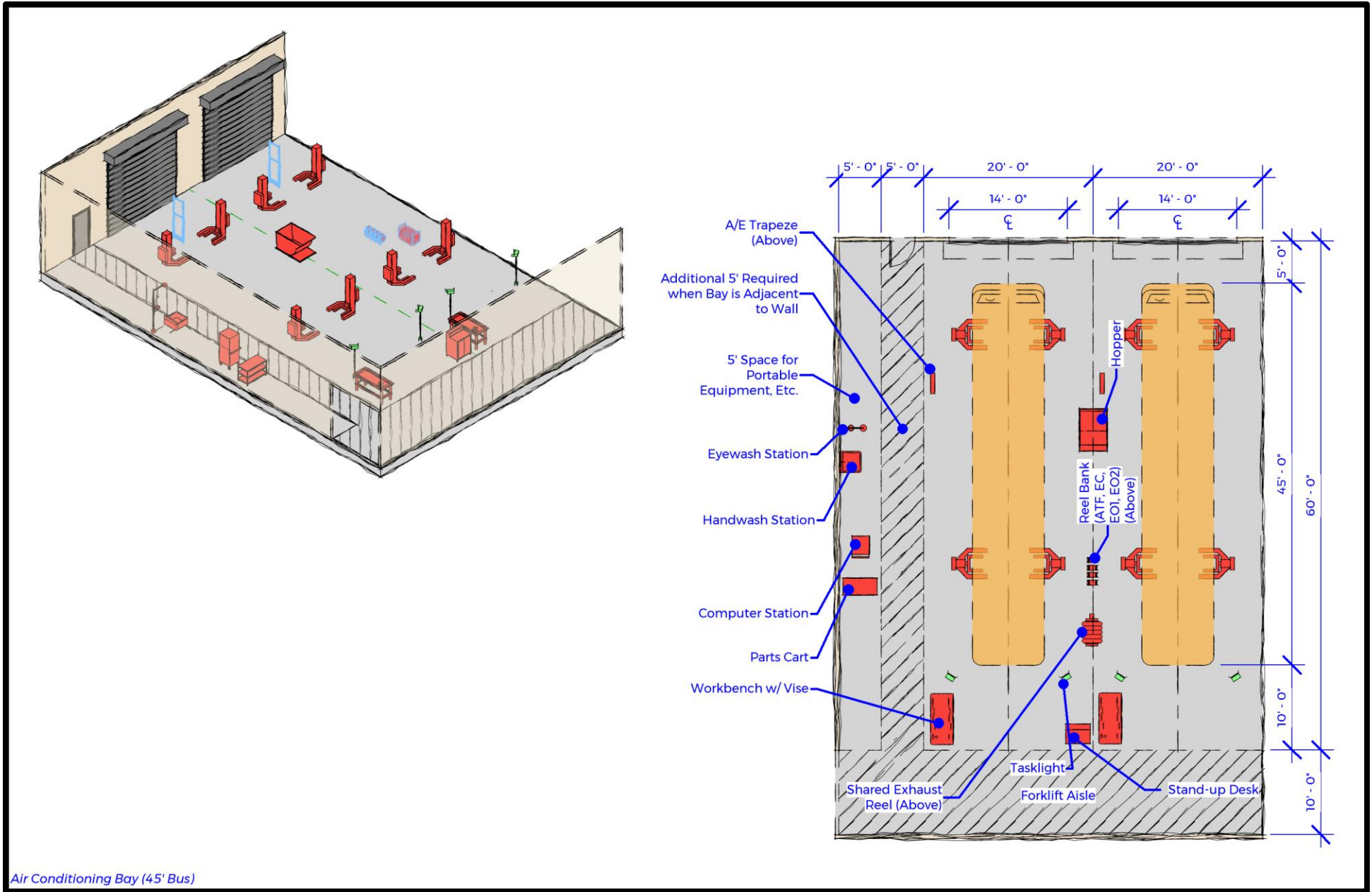

Air Conditioning Bay (45' Bus)

## FUNCTION

- Designated enclosed bay for air conditioning repair 25 – 45 ft transit buses and non-revenue vehicles..

## RELATIONSHIP TO OTHER AREAS

- Near Common Work Area and Portable Equipment Storage.
- Convenient access to Maintenance Break Room, Restrooms, Shower, and Lockers.

## CRITICAL DIMENSIONS

- 19'-0" vertical clearance.
- 20'-0" wide by 60'-0" long.

## COMMENTS / CHARACTERISTICS

- Furnishings: Refer to graphics on previous page.
- Forklift access.

## ARCHITECTURAL

- Finishes
  - ~ Floor: Soil, grease, and water resistant concrete, with integral non-metallic hardener, and clear epoxy sealer. Provide slip resistant finish.
  - ~ Walls: Soil and grease resistant. Epoxy painted to 8'-0" AFF.
  - ~ Ceiling: Painted exposed structure.
- Doors
  - ~ Personnel doors to meet applicable codes and exiting requirements.
  - ~ Exterior sectional overhead door: 14' x 14' motor operated with interior push button controls, and lockout on exterior.
- Bollards on interior and exterior at jambs of overhead door (2 per door).

## STRUCTURAL

- Control joints in floor slab at adequate spacing.
- Structural columns must not be located at the sides between bays.
- Bay to have level floor with warps to slope to drain at intersection to interior drive aisle.
- Structure as needed to support equipment.

## MECHANICAL

- Overhead vehicle exhaust system with 8" exhaust hose on a motorized reel with integral exhaust fan and automatic fan switch at rear of vehicle position shared between bays.
- Heating system must be compatible with possible future use of alternative fueled vehicles.
- Ventilation as required by codes to prevent accumulation of explosive mixtures.
- General ventilation as required by codes.
- As required by equipment.



## ELECTRICAL

- Lighting
  - ~ Maximize day lighting.
  - ~ High bay LED fixture. Refer to chapter 4 for foot candle lighting requirements.
- Power
  - ~ Air/electric drop trapeze mounted quad receptacle, 120VAC, 20A, GFI protected between bays.
  - ~ General purpose duplex receptacles, 120VAC, 20A, GFI protected, on walls, columns, and between overhead doors at 3'-6" AFF.
  - ~ As required by equipment.
- Communications
  - ~ Paging/intercom system speakers in bay.
  - ~ Data port in each repair bay at columns and/or on air/electric trapeze at workbench locations in bay.

## PLUMBING

- Trench drain just inside overhead doors.
- Overhead Lube reel banks with ATF, EC, EO1, and EO2, at rear of vehicle position. Overhead reel bank for WWF at front of vehicle position.
- 3/4" water hose bib with standard faucet between bay doors at 4'-0" AFF (1 per 3 bays).
- Compressed air line with cut-off valve, filter, regulator with gauge, lubricator, cleanout valve, and quick disconnects at 4'-0" AFF (between bay doors) and on air/electric drop "trapeze" between bays at mid-bay (shared with adjacent bays). Provide disconnects for 1/2" and 1" impact tools at locations to be determined during detailed design.
- As required by equipment.



Tire Bay / Storage

(Maintenance)

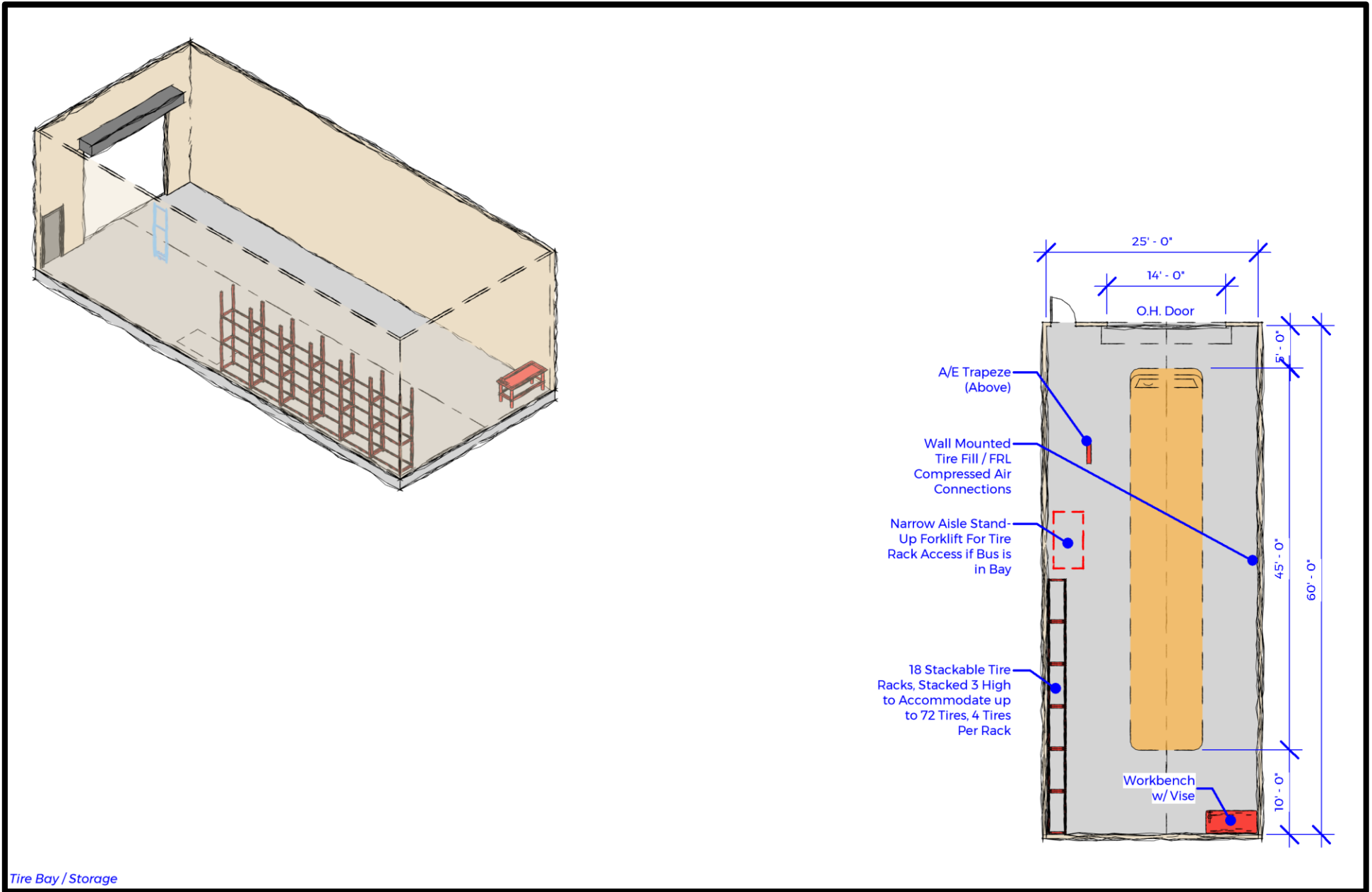

## FUNCTION

- Dedicated bay for tire servicing and repairs.

## RELATIONSHIP TO OTHER AREAS

- Adjacent to Repair Bays.
- Convenient access to Break Room, Restrooms, Shower, and Lockers.

## CRITICAL DIMENSIONS

- 19'-0" vertical clearance.
- 20'-0" wide by 60'-0" long.

## COMMENTS / CHARACTERISTICS

- Furnishings: Refer to graphics on previous page.
- Forklift access.
- Tire Bay and Storage to be acoustically isolated from other functions.

## ARCHITECTURAL

- Finishes
  - ~ Floor: Soil, grease, and water resistant concrete, with integral non-metallic hardener, and clear epoxy sealer. Provide slip resistant finish.
  - ~ Walls: Soil and grease resistant. Epoxy painted to 8'-0" AFF.
  - ~ Ceiling: Painted exposed structure.
- Doors
  - ~ Personnel doors to meet applicable codes and exiting requirements.
  - ~ Exterior sectional overhead door: 14' x 14' motor operated with interior push button controls, and lockout on exterior.
- Bollards on interior and exterior at jambs of overhead door (2 per door).

## STRUCTURAL

- Control joints in floor slab at adequate spacing.
- Structural columns must not be located at the sides between bays.
- Bay to have level floor with warps to slope to drain at intersection to interior drive aisle.
- Structure as needed to support equipment.

## MECHANICAL

- Ventilation as required by codes to prevent accumulation of explosive mixtures.
- General ventilation as required by codes.
- As required by equipment.

## ELECTRICAL

- Lighting
  - ~ Maximize day lighting.
  - ~ High bay LED fixture. Refer to chapter 4 for foot candle lighting requirements.
- Power
  - ~ Air/electric drop trapeze mounted quad receptacle, 120VAC, 20A, GFI protected between bays.
  - ~ General purpose duplex receptacles, 120VAC, 20A, GFI protected, on walls, columns, and between overhead doors at 3'-6" AFF.
  - ~ As required by equipment.
- Communications
  - ~ Paging/intercom system speakers in bay.
  - ~ Data port at workbench locations.

## PLUMBING

- Trench drain just inside overhead doors.
- 3/4" water hose bib with standard faucet between bay doors at 4'-0" AFF (1 per 3 bays).
- Compressed air line with cut-off valve, filter, regulator with gauge, lubricator, cleanout valve, and quick disconnects at 4'-0" AFF (between bay doors) and on air/electric drop "trapeze" between bays at mid-bay (shared with adjacent bays). Provide disconnects for 1/2" and 1" impact tools at locations to be determined during detailed design.
- As required by equipment.

Common Work Area

(Maintenance)

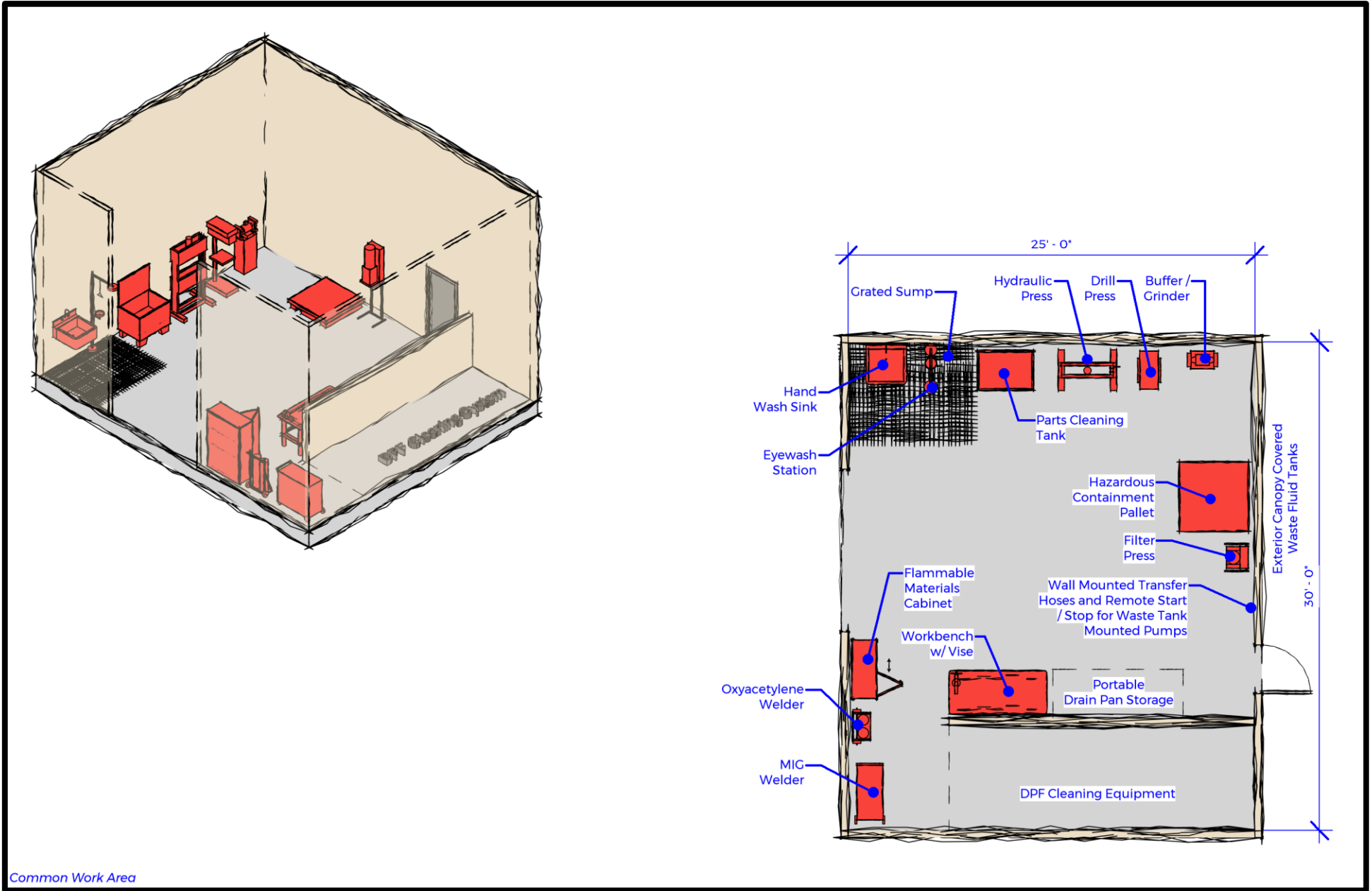

Common Work Area

## FUNCTION

- Designated area for bench work and shop equipment that supports the Repair Bays.

## RELATIONSHIP TO OTHER AREAS

- Convenient access from Repair Bays.

## CRITICAL DIMENSIONS

- 14'-0" vertical clearance.

## COMMENTS / CHARACTERISTICS

- Furnishings: Refer to graphics on previous page.
- Forklift access.

## ARCHITECTURAL

- Finishes
  - ~ Floor: Soil, grease, and water resistant concrete, with integral non-metallic hardener, and clear epoxy sealer. Provide slip resistant finish.
  - ~ Walls: Soil and grease resistant. Epoxy painted to 8'-0" AFF.
  - ~ Ceiling: Painted exposed structure.
- Doors
  - ~ Personnel doors to meet applicable codes and exiting requirements.
  - ~ Interior overhead door: 10' x 10' motor operated with interior push button controls.
- Bollards on interior and exterior at jambs of overhead door (2 per door).

## STRUCTURAL

- Control joints in floor slab at adequate spacing.
- Structure as needed to support equipment.

## MECHANICAL

- Ventilation as required by codes to prevent accumulation of explosive mixtures.
- General ventilation as required by codes.
- As required by equipment.

## ELECTRICAL

- Lighting
  - ~ Maximize day lighting.
  - ~ High bay LED fixture. Refer to chapter 4 for foot candle lighting requirements.
- Power
  - ~ General purpose duplex receptacles, 120VAC, 20A, GFI protected, on walls, columns, and between overhead doors at 3'-6" AFF.
  - ~ As required by equipment.
- Communications
  - ~ Paging/intercom system speakers in shop.
  - ~ Data port on columns and at workbench locations in shop.

## PLUMBING

- Compressed air line with cut-off valve, filter, regulator with gauge, lubricator, cleanout valve, and quick disconnects on walls at 4'-0" AFF. Provide disconnects for 1/2" and 1" impact tools at locations to be determined during detailed design.
- As required by equipment.

Electronics Shop

(Maintenance)

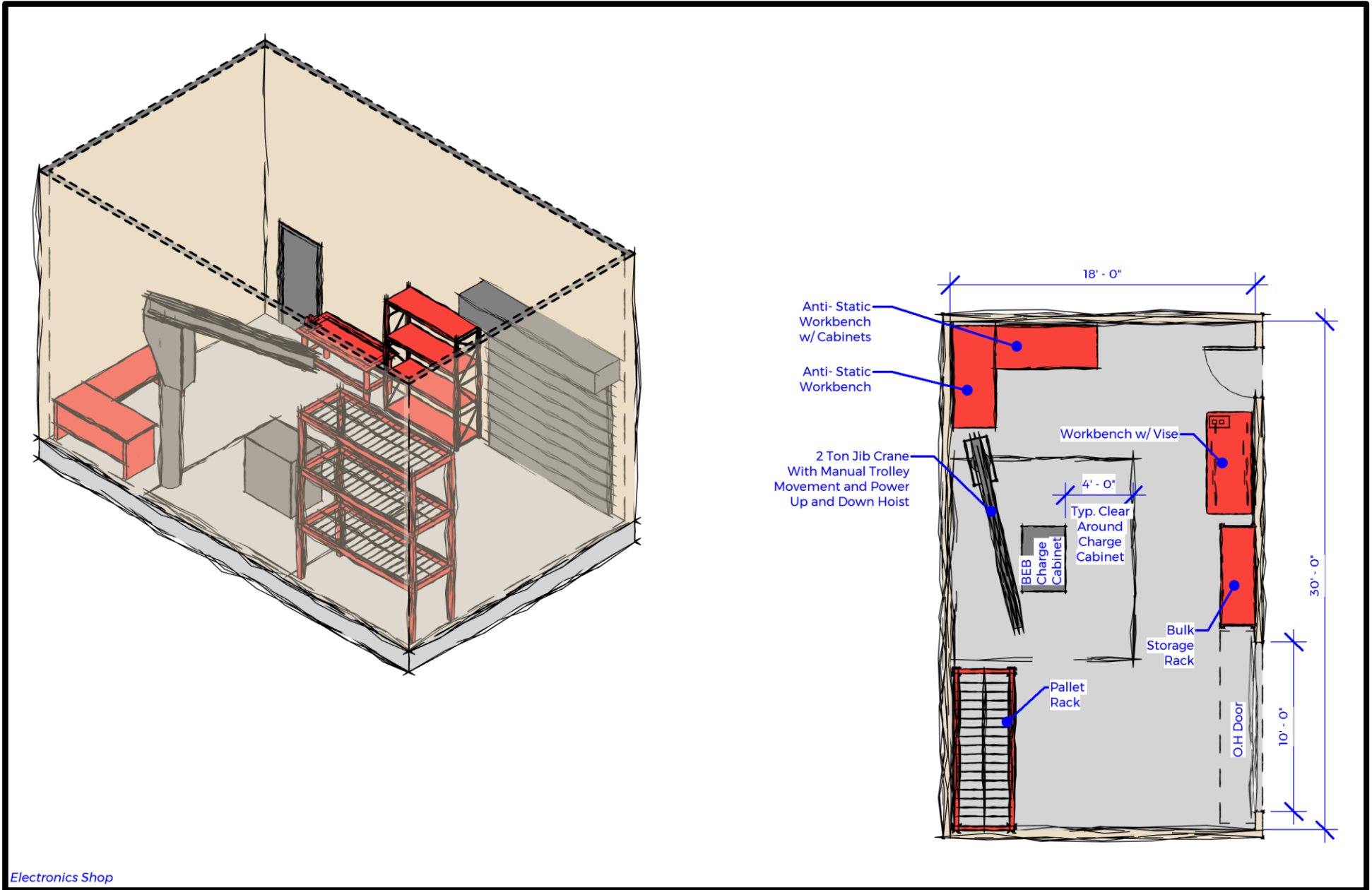

Electronics Shop

## FUNCTION

- Secure enclosed space for repair of bus electrical components and Battery Electric Bus charging cabinets.

## RELATIONSHIP TO OTHER AREAS

- Adjacent to Repair Bays.

## CRITICAL DIMENSIONS

- 14'-0" vertical clearance minimum.

## COMMENTS / CHARACTERISTICS

- Furnishings: Refer to graphics on previous page.

## ARCHITECTURAL

- Finishes
  - ~ Floor: Soil, grease, and water resistant concrete, with integral non-metallic hardener, and clear epoxy sealer. Provide slip resistant finish.
  - ~ Walls: Soil and grease resistant. Epoxy painted to 8'-0" AFF.
  - ~ Ceiling: Painted exposed structure.
- Doors
  - ~ Personnel doors to meet applicable codes and exiting requirements.
  - ~ Interior overhead door: 10' x 10' motor operated with interior push button controls.
- Bollards on interior and exterior at jambs of overhead door.

## STRUCTURAL

- Control joints in floor slab at adequate spacing.
- Structure as needed to support equipment.

## MECHANICAL

- Ventilation as required by codes to prevent accumulation of explosive mixtures.
- General ventilation as required by codes.
- As required by equipment.

## ELECTRICAL

- Lighting
  - ~ Maximize day lighting.
  - ~ High bay LED fixture. Refer to chapter 4 for foot candle lighting requirements.
- Power
  - ~ General purpose duplex receptacles, 120VAC, 20A, GFI protected, on walls at 3'-6" AFF.
  - ~ 480V 3 Phase switched disconnect to energize BEB charging equipment for testing and maintenance.
  - ~ As required by equipment.
- Communications
  - ~ Paging/intercom system speakers.

## PLUMBING

- Compressed air line with cut-off valve, filter, regulator with gauge, lubricator, cleanout valve, and quick disconnects on walls at 3'-6" AFF. Provide disconnects at locations to be determined during detailed design.
- As required by equipment.



## TOOL BOX STORAGE

(MAINTENANCE)

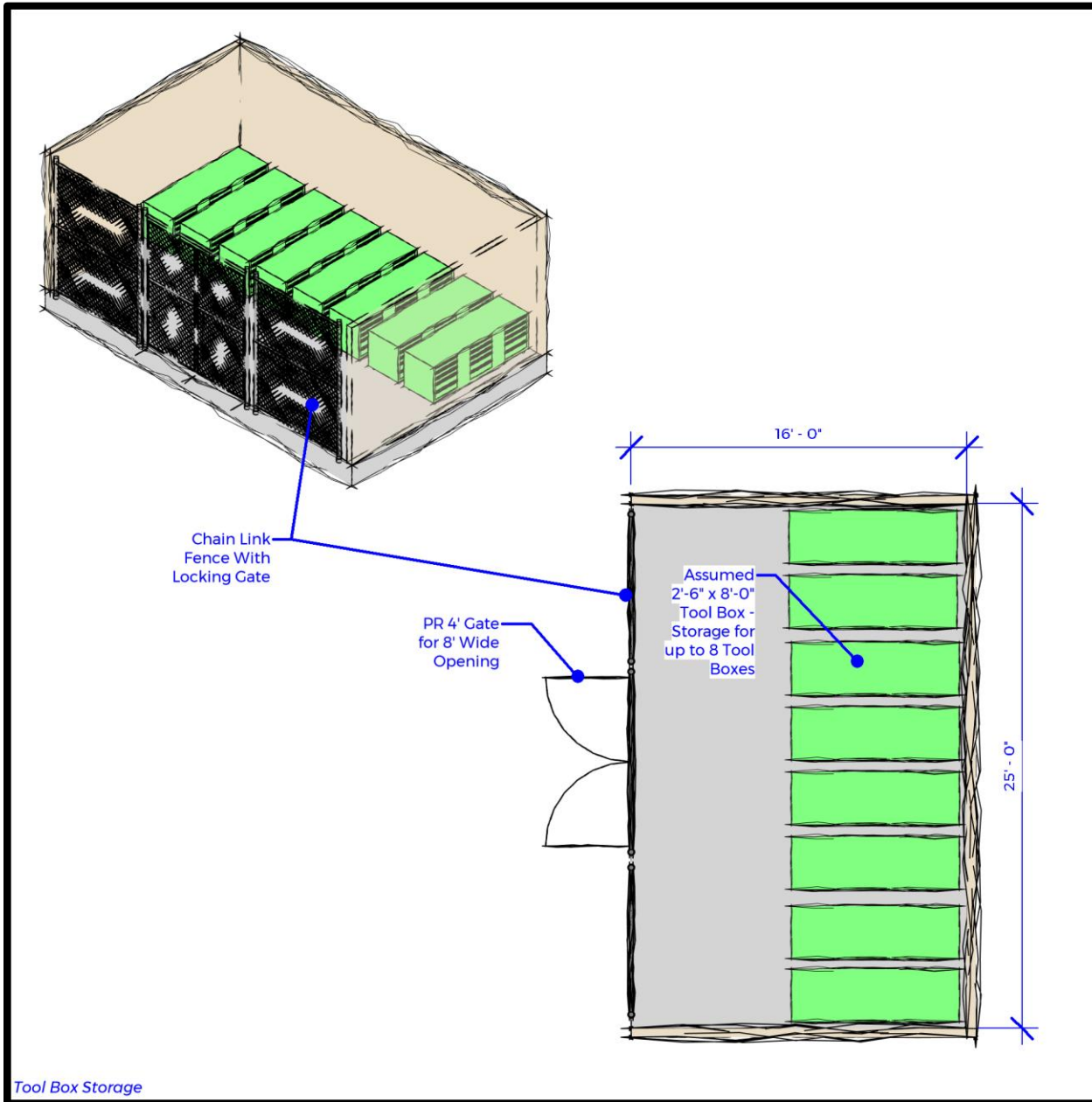

### Function

- Enclosed secure area for storage of mechanic tool boxes.

### Relationship to other Areas

- Near Repair Bays.

### Comments / Characteristics

- Furnishings: Refer to graphic on this page.
- Utility Requirements: Grounded electrical convenience outlets, ventilated, and heated.
- Floor Finishes: Soil, grease, and water resistant concrete, with clear epoxy sealer. Provide slip resistant finish.
- Wall Finishes: Soil and grease resistant. Epoxy painted CMU to 8'-0" AFF. Chainlink fence to 8'-0: AFF.
- Ceiling Finishes: Painted exposed structure.
- Lighting: High bay fixture or service Light Fixture. Refer to Chapter 4 for foot candle and fixture requirements.

## Forklift Parking

*(Maintenance)*

### FUNCTION

- Parking for non-revenue support vehicle, 1 forklift.

### RELATIONSHIP TO OTHER AREAS

- Near Repair Bays and Shops.

### COMMENTS / CHARACTERISTICS

- Furnishings: Charging station for forklift.
- Utility Requirements: Grounded electrical convenience outlets and heated.
- Floor Finishes: Soil, grease, and water resistant concrete, with clear epoxy sealer. Provide slip resistant finish.
- Wall Finishes: Epoxy painted concrete block.
- Ceiling Finishes: Painted exposed structure.
- Lighting: High bay fixture. Refer to Chapter 4 for foot candle and fixture requirements.

## FLOOR SCRUBBER PARKING

(MAINTENANCE)

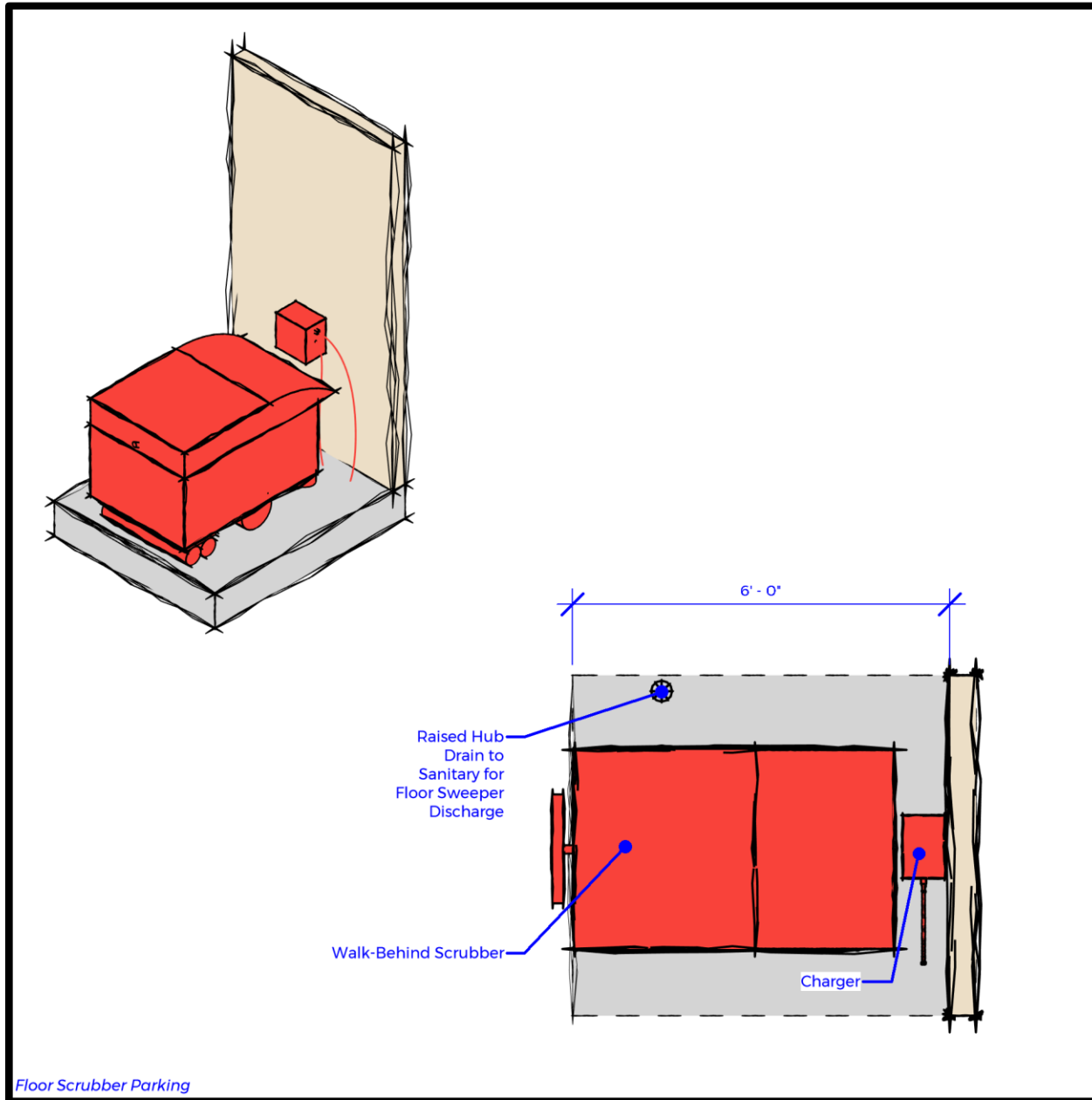

Floor Scrubber Parking

### Function

- Parking for non-revenue support vehicle, 1 scrubber.

### Relationship to other Areas

- Near Repair Bays and Shops.

### Comments / Characteristics

- Furnishings: Charging station for forklift.
- Utility Requirements: 480V 3 phase disconnect for wall mounted charger and heated.
- Floor Finishes: Soil, grease, and water resistant concrete, with clear epoxy sealer. Provide slip resistant finish.
- Wall Finishes: Epoxy painted concrete block.
- Ceiling Finishes: Painted exposed structure.
- Lighting: High bay fixture. Refer to Chapter 4 for foot candle and fixture requirements.

## Portable Equipment Storage

*(Maintenance)*

### FUNCTION

- Designated area for the storage of portable repair bay equipment.

### RELATIONSHIP TO OTHER AREAS

- Adjacent to Repair Bays.

### COMMENTS / CHARACTERISTICS

- Furnishings: None.
- Utility Requirements: Grounded electrical convenience outlets, ventilated, and heated.
- Floor Finishes: Soil, grease, and water resistant concrete, with clear epoxy sealer. Provide slip resistant finish.
- Wall Finishes: Epoxy painted concrete block.
- Ceiling Finishes: Painted exposed structure.
- Lighting: High bay fixture. Refer to Chapter 4 for foot candle and fixture requirements.

## Waste Fluid Collection

*(Maintenance)*

### FUNCTION

- Canopy covered area for storage of waste collection tanks.

### RELATIONSHIP TO OTHER AREAS

- Adjacent to Repair Bays.

### COMMENTS / CHARACTERISTICS

- Furnishings: None.
- Utility Requirements: Grounded electrical convenience outlets, ventilated, and heated.
- Floor Finishes: Soil, grease, and water resistant concrete, with clear epoxy sealer. Provide slip resistant finish.
- Wall Finishes: Epoxy painted concrete block.
- Ceiling Finishes: Painted exposed structure.
- Lighting: Waterproof Service Light Fixture. Refer to Chapter 4 for foot candle and fixture requirements.

## Battery Room

*(Maintenance)*

### FUNCTION

- Pre-engineered secure portable container for the storage and charging of batteries.

### RELATIONSHIP TO OTHER AREAS

- Stored outside near Parts Storeroom.

### COMMENTS / CHARACTERISTICS

- Furnishings: Hardwood bench for XX batteries, battery charger with bus bar, battery cart, battery load tester, jumper cart, battery lift cart, battery storage containment pallet, hand wash sink, and emergency eye wash safety shower with alarm.
- Utility Requirements: Water, drain, electrical power as required by container and equipment.
- Floor Finishes: Acid resistant grating (removable) with containment sump.
- Wall Finishes: Acid / chemical resistant coating.
- Ceiling Finishes: Acid / chemical resistant coating.
- Lighting: Fluorescent strip by container manufacturer.
- Forklift access to insert / remove pallets of batteries.
- Provide for charging up to XX batteries at a time.
- Drain from sink to be acid neutralized.
- Provide concrete slab on which to set pre-engineered container.
- 8'-0" vertical clearance inside container.

**THIS PAGE INTENTIONALLY LEFT BLANK**

Lube / Compressor Room

(Maintenance)

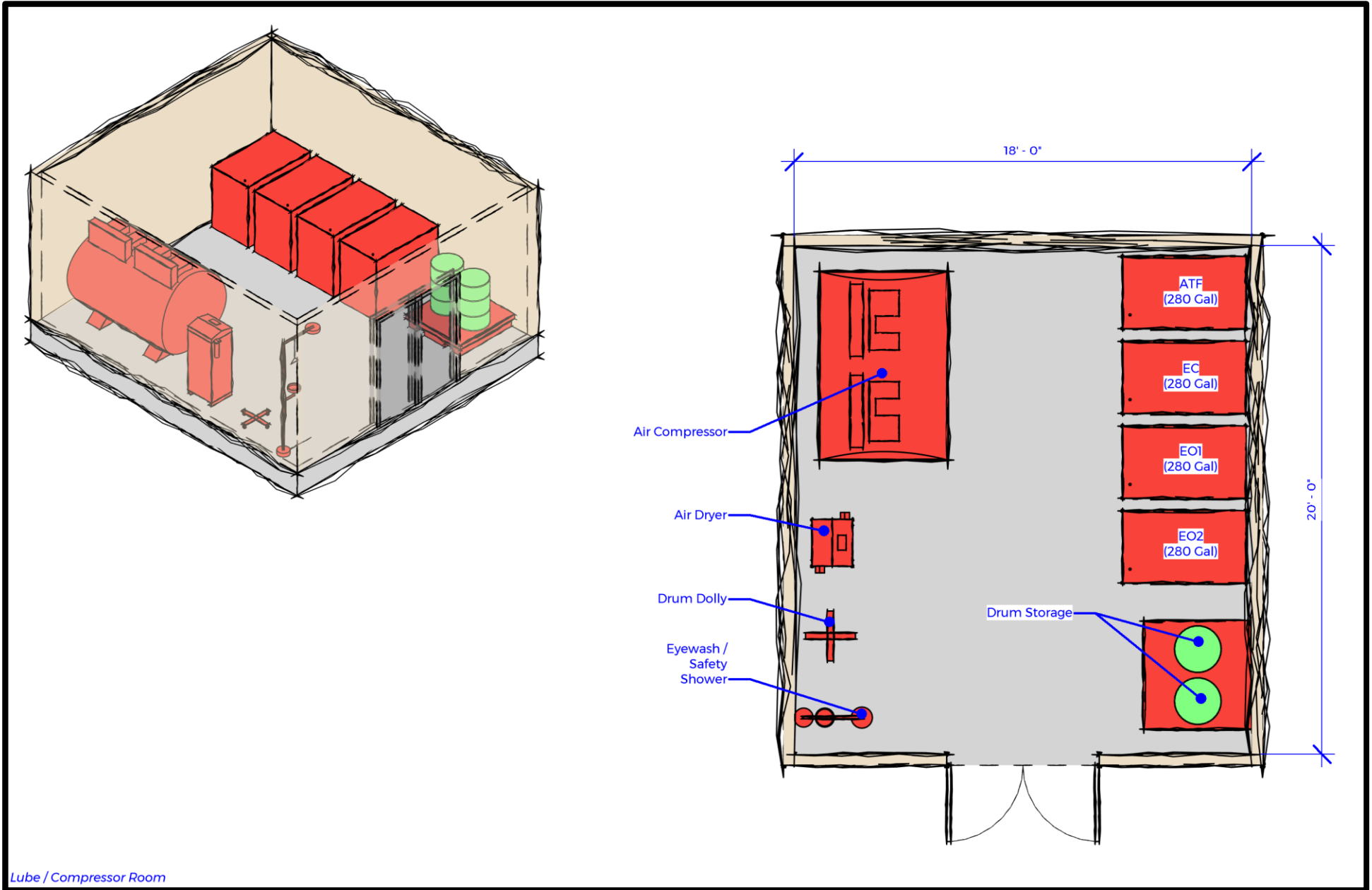

Lube / Compressor Room



## FUNCTION

- Enclose room for the purpose of storage and distribution of lubricants to the facility.

## RELATIONSHIP TO OTHER AREAS

- Centrally located to minimize piping runs.
- Accessible from exterior for deliveries.

## CRITICAL DIMENSIONS

- 12'-0" vertical clearance.

## COMMENTS / CHARACTERISTICS

- Furnishings: Refer to graphic on previous page.
- Acoustically and physically separated from personnel areas to prevent migration of noise, dirt, and fumes.
- Provide for easy cleaning below grating.
- Forklift accessible.

## ARCHITECTURAL

- Finishes
  - ~ Floor: Soil, grease, and water resistant concrete, with integral non-metallic hardener, and clear epoxy sealer. Provide slip resistant finish.
  - ~ Walls: Soil and grease resistant. Epoxy painted to full height.
  - ~ Ceiling: Painted exposed structure.
- Doors
  - ~ Double 3'-0" wide hollow metal door with interior exit device. Provide fire separation between this space and adjacent spaces, where required by code. Make liquid-tight joints where all walls join the floor. Provide placards in a conspicuous location outside of the room indicating the presence of flammable/combustible liquids, and the quantities of each.

## STRUCTURAL

- Control joints in floor slab at adequate spacing.
- Structure as needed to support equipment.
- Containment sumps (below storage drums) covered with grating (110% of capacity of stored and used drums).

- Provide seismic bracing for equipment, where required by code.

## MECHANICAL

- General ventilation as required by codes.
- As required by equipment.

## ELECTRICAL

- Lighting
  - ~ Service Light Fixture – Shop. Refer to chapter 4 for foot candle lighting requirements.
- Power
  - ~ General purpose duplex receptacles, 120VAC, 20A, GFI protected, on walls at 3'-6" AFF.
  - ~ As required by equipment.
- Communications
  - ~ Paging/intercom system speakers.
  - ~ Bond and ground all tanks, piping, and discharge equipment.

## PLUMBING

- 3/4" water hose bib with standard faucet at 3'-6" AFF.
- Compressed air line with cut-off valve, separator, regulator with gauge, lubricator, cleanout valve, and quick disconnects on wall at 3'-6" AFF for each lubricant pump.
- Regulator and pressure relief valve in compressed air line to lube pumps. Provide vent piping from tank to exterior of building for tanks with combustible and/or flammable fluids, as required by code.
- As required by equipment.

## Mechanical Room

*(Maintenance)*

### FUNCTION

- Enclosed separately secured space designated for mechanical building support systems.

### RELATIONSHIP TO OTHER AREAS

- Adjacent to Electrical Room

### COMMENTS / CHARACTERISTICS

- Provide double doors as needed for access to equipment.
- Furnishings: Mechanical equipment.
- Utility Requirements: As required by equipment.
- Floor Finishes: Sealed concrete.
- Wall Finishes: Painted gypsum board and/or concrete block.
- Ceiling Finishes: Painted exposed structure.
- Lighting: Service Light Fixture – Utility spaces. Refer to Chapter 4 for foot candle and fixture requirements.

## Electrical Room

*(Maintenance)*

### FUNCTION

- Designated space for electrical building support equipment.

### RELATIONSHIP TO OTHER AREAS

- Adjacent to Mechanical Room.

### COMMENTS / CHARACTERISTICS

- Provide double doors as needed for access to equipment.
- Furnishings: Electrical equipment.
- Utility Requirements: As required by equipment.
- Floor Finishes: Sealed concrete.
- Wall Finishes: Painted gypsum board and/or concrete block.
- Ceiling Finishes: Painted exposed structure.
- Lighting: Service Light Fixture – Utility spaces. Refer to Chapter 4 for foot candle and fixture requirements.

## PARTS STOREROOM

### FUNCTIONAL RELATIONSHIP DIAGRAM

The relationships between the spaces within this section are shown below. The design should accommodate these relationships in order to maximize operational efficiency. This diagram is not meant to be a floor plan, and serves only as a representational relationship diagram.

### FUNCTIONAL AREA MODULES

Each functional area within this section has been individually defined as a module. Each module has information regarding the function of the space, relationships to other areas and other information received during interviews with Yuba-Sutter Transit staff.

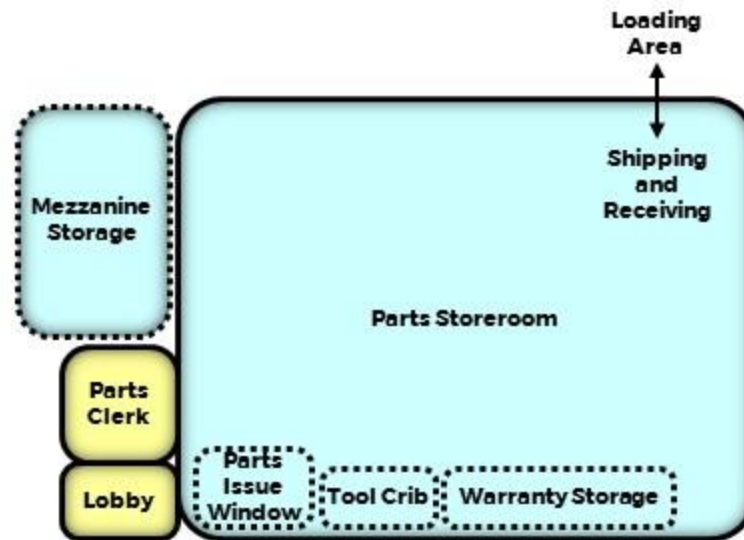

LOBBY

(PARTS STOREROOM)

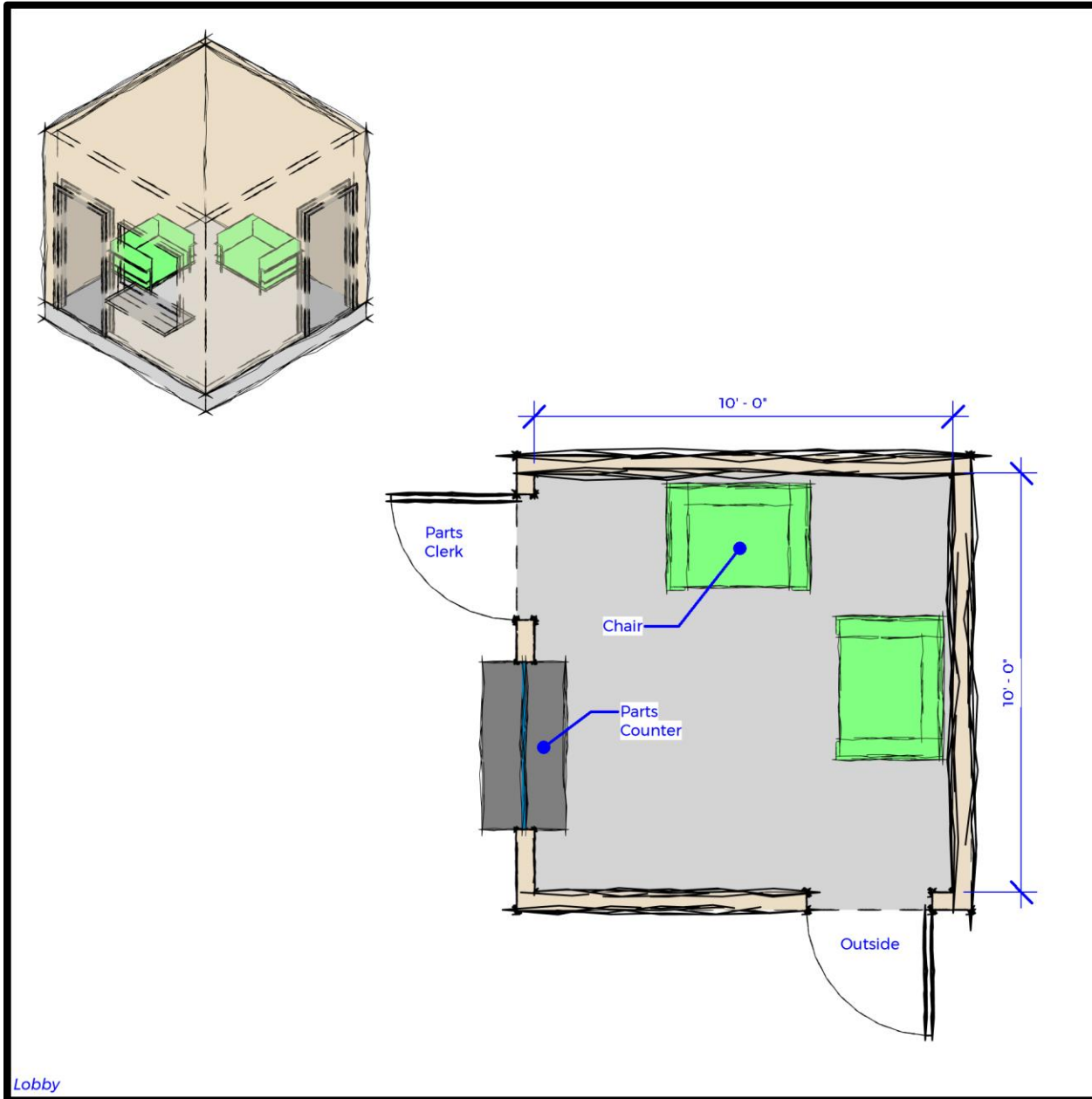

Function

- Parts lobby area with seating for up to 2 people.

Relationship to other Areas

- Adjacent to Parts Clerk.

Comments / Characteristics

- Furnishings: Refer to graphic on this page.
- Utility requirements: Grounded electrical convenience outlets, intercom/paging system, air conditioned and heated.
- Window to outside if possible. Window to be fixed.
- Floor Finishes: Resilient flooring.
- Wall Finishes: Painted gypsum board and/or concrete block.
- Ceiling Finishes: Acoustical ceiling.
- Lighting: Office Light Fixture. Refer to Chapter 4 for foot candle and fixture requirements.

## PARTS CLERK

(PARTS STOREROOM)

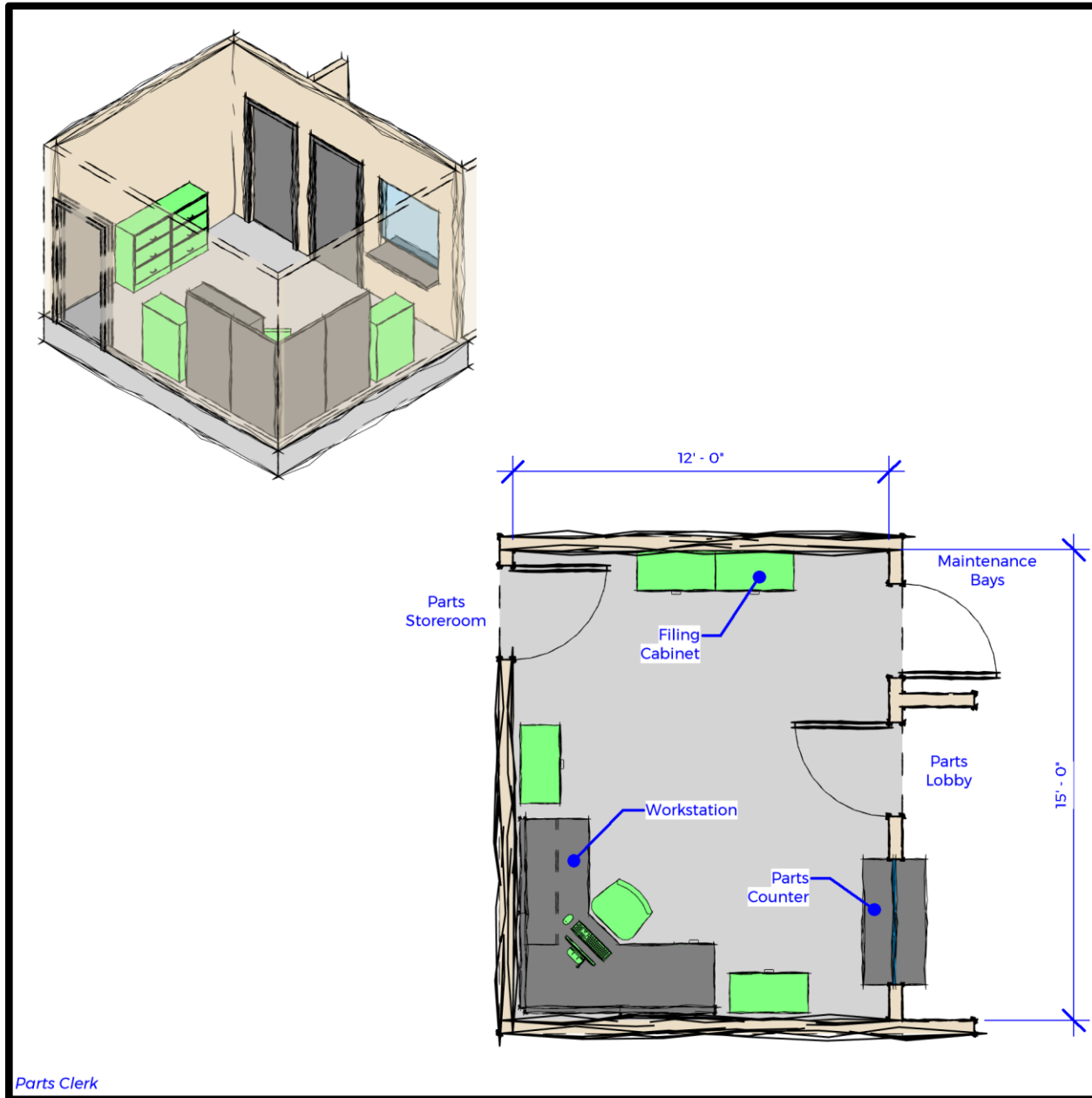

### Function

- Enclosed private office for the Parts Clerk.

### Relationship to other Areas

- Adjacent to Lobby and Parts Storeroom.

### Comments / Characteristics

- Furnishings: Refer to graphic on this page. See Typical Workstation 1A.
- Utility Requirements: Grounded electrical convenience outlets, telephone, intercom/paging system, conduit for network computer system, air conditioned, and heated.
- Floor Finishes: Resilient flooring.
- Wall Finishes: Painted gypsum board and or concrete block.
- Ceiling Finishes: Acoustical ceiling.
- Lighting: Office Light Fixture. Refer to Chapter 4 for foot candle and fixture requirements.
- Acoustically separated from surround spaces.

Parts Storeroom

(Parts Storeroom)

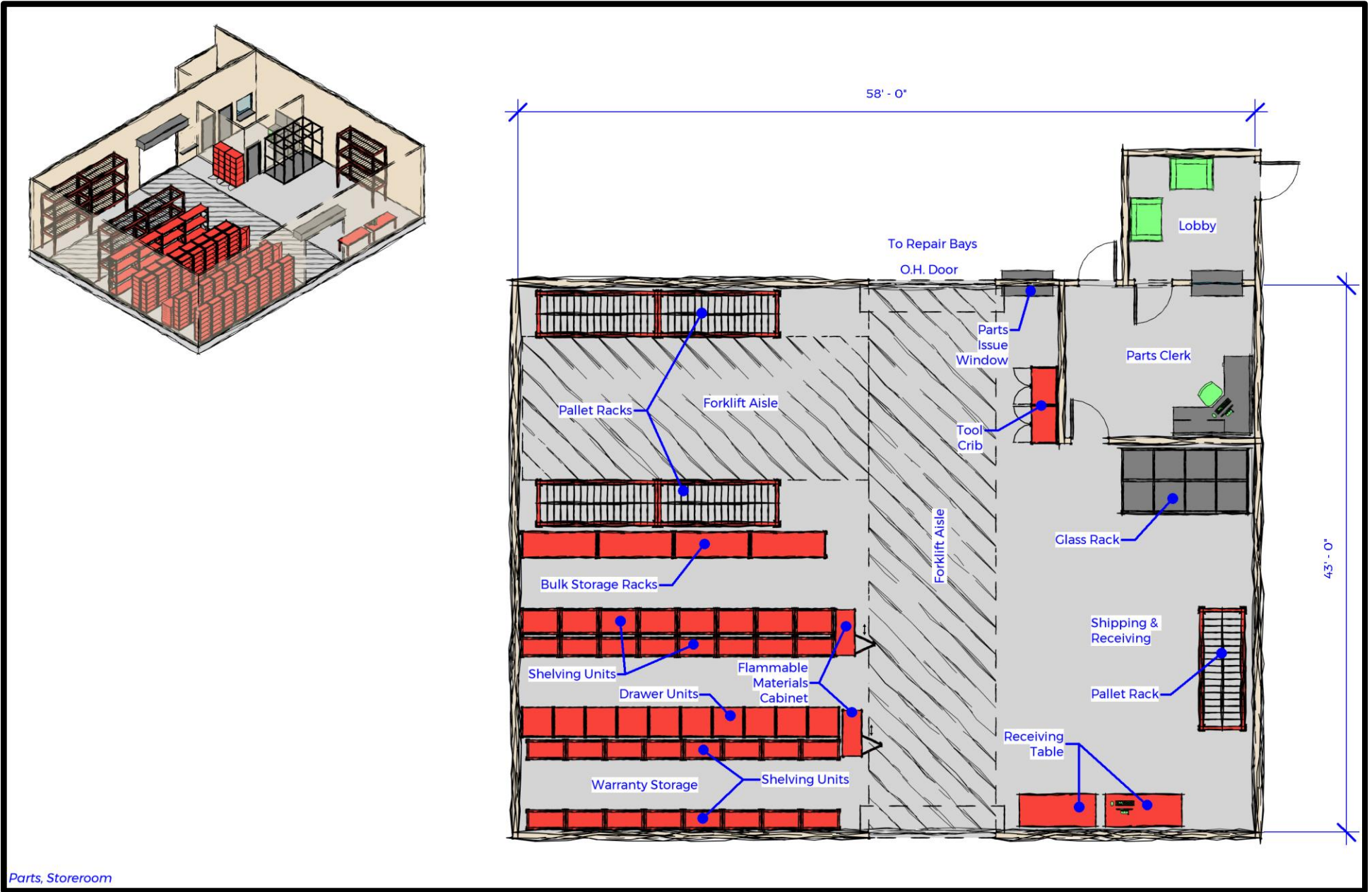



## FUNCTION

- Dedicated secure area for receiving, storing, and issuing of parts and materials.

## RELATIONSHIP TO OTHER AREAS

- Adjacent to Parts Clerk and Shipping and Receiving.
- Near Repair Bays and Shops.

## CRITICAL DIMENSIONS

- 19'-0" vertical clearance.

## COMMENTS / CHARACTERISTICS

- Furnishings:
  - ~ Storage Equivalent Capacity – WxDxH
  - ~ 40 FPE Full Pallet Equivalent 4'x4'x4'
  - ~ (160) BBE Bulk Box Equivalent 20"x24"x24"
  - ~ (40) SBE Small Box Equivalent 15"x27"x12"
  - ~ (168) FSE Full Shelft Equivalent 36"x18"x12"
  - ~ (2) FMC Flammable Materials Cabinet
  - ~ (2) LDC Locking Door Cabinet
  - ~ (90) DCE Drawer Cabinet Equivalent 30"x27"xN
- Forklift accessible.
- Exterior access.
- Card access control.
- Include dedicated area for Warranty storage and Tool Crib cabinet within Parts Storeroom.

## ARCHITECTURAL

- Finishes
  - ~ Floor: Soil, grease, and water resistant concrete, with integral non-metallic hardener, and clear epoxy sealer. Provide white slip resistant finish.
  - ~ Walls: Soil and grease resistant. Epoxy painted to 8'-0" AFF.
  - ~ Ceiling: Painted exposed structure.
- Doors
  - ~ Personnel doors to meet applicable codes and exiting requirements.

- ~ Exterior overhead door: High lift aluminum frame with full view glass panels, 10'x10', automatic operator, interior push button controls, and lockout on exterior.
- ~ 10'x10' overhead coiling door for forklift access.
- Bollards on interior and exterior jambs of overhead doors (4 per door).

## STRUCTURAL

- Control joints in floor slab at adequate spacing.
- Structure as needed to support equipment.

## MECHANICAL

- General ventilation as required by codes.
- As required by equipment.

## ELECTRICAL

- Lighting
  - ~ High bay fixture. Refer to chapter 4 for foot candle and fixture requirements.
  - ~ Orient lighting at 45 degrees to room walls to reduce shadows and dark areas resulting from future modified racking configurations.
- Power
  - ~ General purpose duplex receptacles, 120VAC, 20A, GFI protected, on walls and columns at 3'-6" AFF.
  - ~ 480 VAC 3 Phase with disconnect for forklift charging point.
  - ~ As required by equipment.
- Communications
  - ~ Paging/intercom system speakers.

## PLUMBING

- 24" wide trench drain just inside overhead door with removable grating to oil/water separator and waste water treatment plant (WWTP).
- 3/4" water hose bib with standard faucet at 3'-6" AFF.
- Compressed air line with cut-off valve, filter, regulator with gauge, lubricator, and quick disconnects on walls at 1066.8 mm (3'-6") AFF. Provide disconnects at locations to be determined during detailed design.
- As required by equipment.

## Warranty Storage

*(Parts Storeroom)*

### FUNCTION

- Designated shelving racks for storage of warranty items.

### RELATIONSHIP TO OTHER AREAS

- Near Parts Clerk.

### COMMENTS / CHARACTERISTICS

- Furnishings: Refer to graphic on this page.
- Utility Requirements: None.
- Floor Finishes: None.
- Wall Finishes: None.
- Ceiling Finishes: None.
- Lighting: High bay fixture. Refer to Chapter 4 for foot candle and fixture requirements.

## Tool Crib

*(Parts Storeroom)*

### FUNCTION

- Secure cabinet for the storage of maintained tools and equipment.

### RELATIONSHIP TO OTHER AREAS

- Adjacent to Repair Bays and Shops.

### COMMENTS / CHARACTERISTICS

- Furnishing: None.
- Utility requirements: None.
- Floor Finishes: None.
- Wall Finishes: None.
- Ceiling Finished: None.
- Lighting: Service Light Fixture. Refer to Chapter 4 for foot candle and fixture requirements.

## Shipping and Receiving

(Parts Storeroom)

### FUNCTION

- Designated area within the Parts Storeroom for staging received parts and parts waiting to be shipped.

### RELATIONSHIP TO OTHER AREAS

- Within Parts Storeroom.

### COMMENTS / CHARACTERISTICS

- Furnishings: Wood top check-in table.
- Utility Reequipments: Grounded electrical convenience outlets, telephone, intercom/paging system, conduit for network computer, and heated.
- Floor Finishes: Soil, grease, and water resistant concrete, with clear epoxy sealer. Provide white slip resistant finish.
- Wall Finishes: Epoxy painted concrete block.
- Ceiling Finishes: Painted exposed structure.
- Lighting: High bay fixture. Refer to Chapter 4 for foot candle and fixture requirements.

## Loading Area

(Parts Storeroom)

### FUNCTION

- Level paved area for parking vehicles loading and unloading into Parts Storeroom.

### RELATIONSHIP TO OTHER AREAS

- Near and within close visual view of Parts Clerk.

### COMMENTS / CHARACTERISTICS

- Furnishings: None.
- Utility Reequipments: Grounded electrical convenience outlets.
- Floor Finishes: Asphalt. Minimum 12'-0" wide x 12'-0" long concrete pavement section at forklift vehicle loading / unloading area.
- Wall Finishes: None.
- Ceiling Finishes: Provide 8 foot deep canopy over exterior overhead door to cover rear of delivery vehicle when loading / unloading.
- Lighting: High bay fixture. Refer to Chapter 4 for foot candle and fixture requirements.

## Mezzanine Storage

*(Parts Storeroom)*

### FUNCTION

- Designated storage area above Parts Storeroom for storage of less frequently used large parts.

### RELATIONSHIP TO OTHER AREAS

- Above Parts Storeroom.

### COMMENTS / CHARACTERISTICS

- Furnishings: Shelving racks.
- Utility Requirements: Grounded electrical convenience outlets, ventilated, and heated.
- Floor Finishes: Sealed concrete.
- Wall Finishes: Painted gypsum board.
- Ceiling Finishes: Painted exposed structure.
- Lighting: Service Light Fixture – Storage rooms. Refer to Chapter 4 for foot candle and fixture requirements.

## FUEL / WASH / SERVICE

### FUNCTIONAL RELATIONSHIP DIAGRAM

The relationships between the spaces within this section are shown below. The design should accommodate these relationships in order to maximize operational efficiency. This diagram is not meant to be a floor plan, and serves only as a representational relationship diagram.

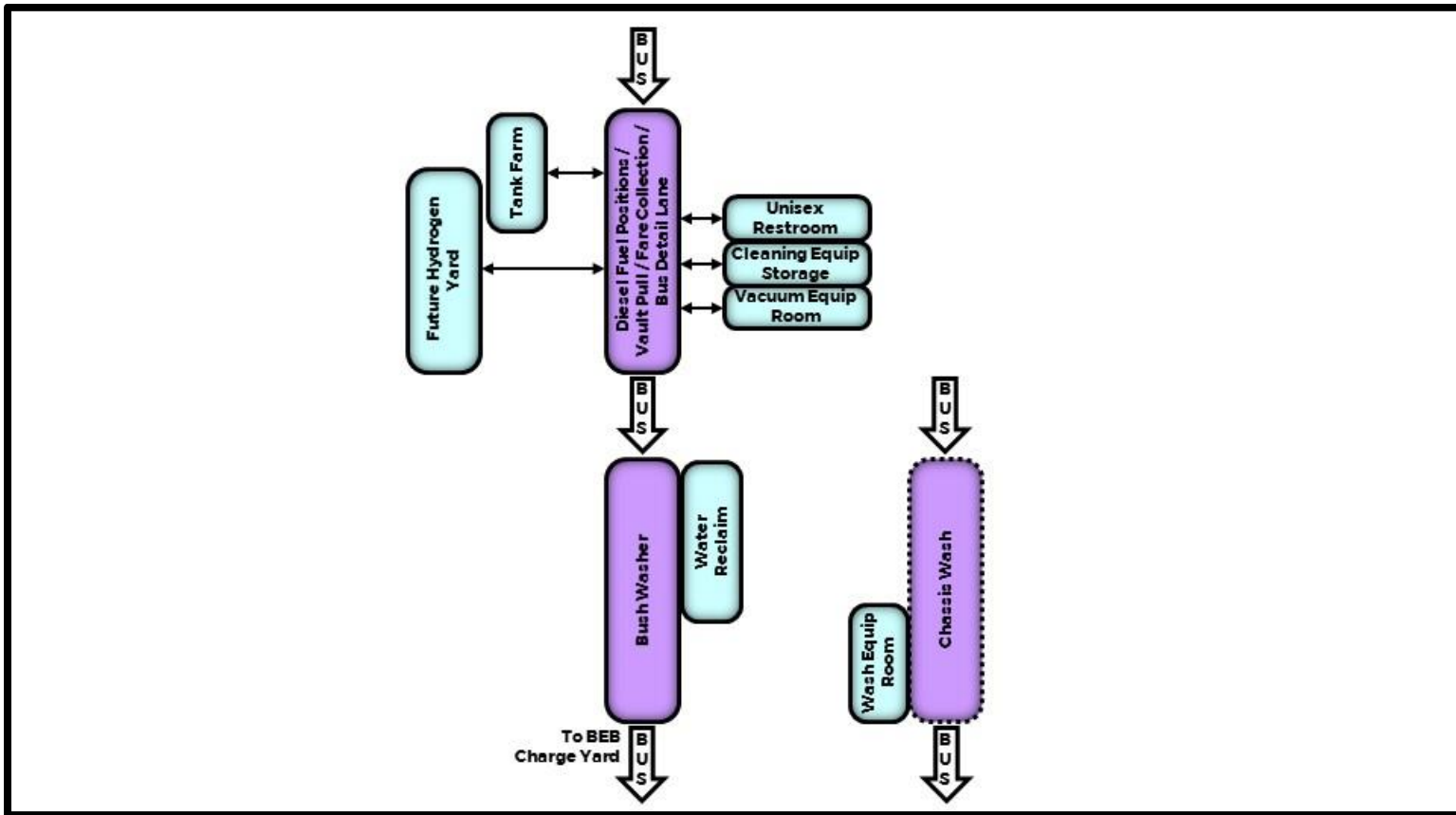

### FUNCTIONAL AREA MODULES

Each functional area within this section has been individually defined as a module. Each module has information regarding the function of the space, relationships to other areas and other information received during interviews with Yuba-Sutter Transit staff.

Fueling Position

(Fuel / Wash / Service)

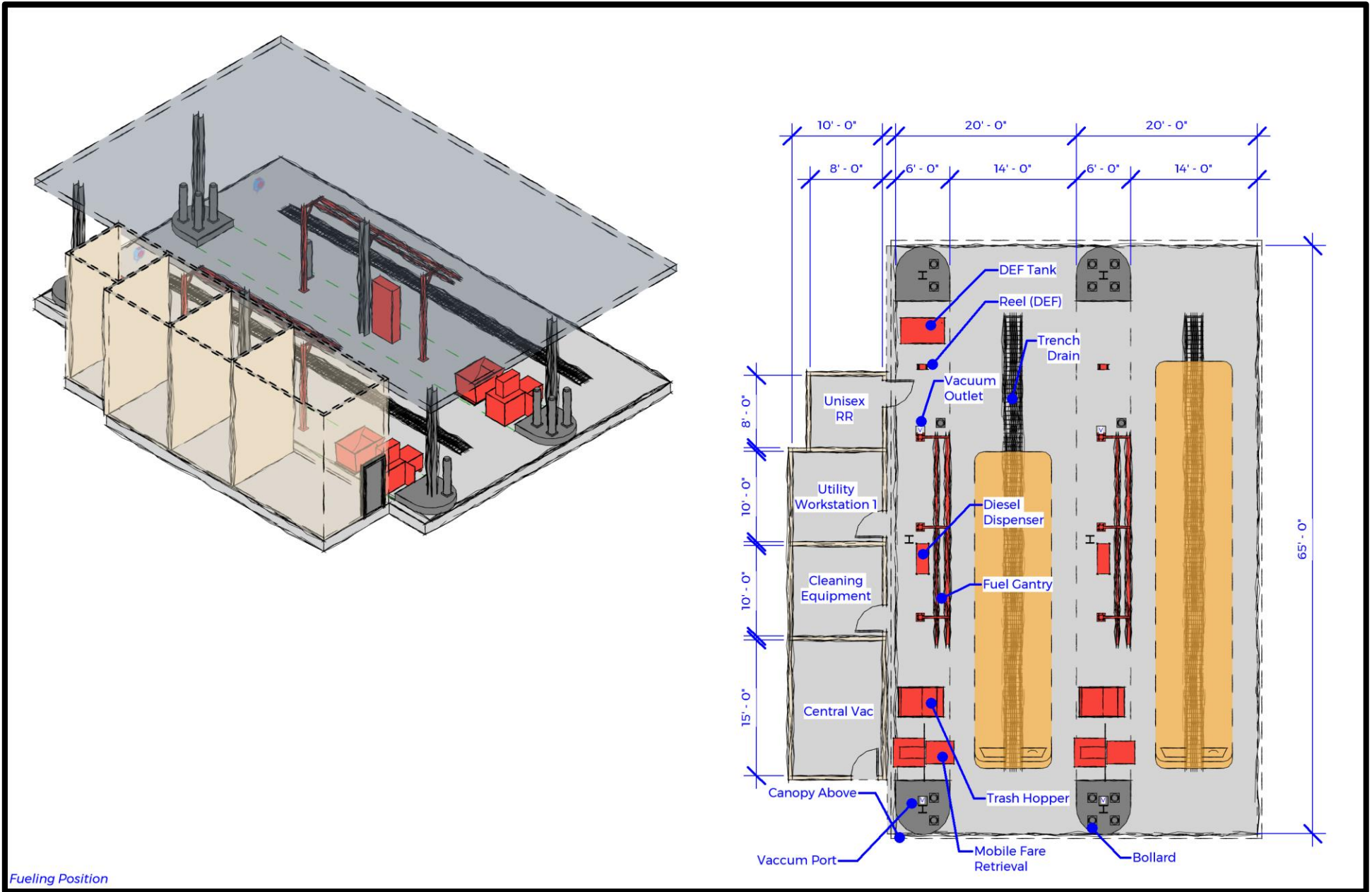

Fueling Position

## FUNCTION

- Canopy covered drive-thru lanes for fueling of buses and non-revenue vehicles as needed. Space to be used for covered Detail Clean position.

## RELATIONSHIP TO OTHER AREAS

- Convenience access to / from vehicle parking.
- Efficiently located within site traffic flow.

## CRITICAL DIMENSIONS

- 17'-6 to allow for future high capacity overhead pantograph charging, vertical clearance to underside of canopy structure.
- Bay size: 20' x 55'

## COMMENTS / CHARACTERISTICS

- Furnishings: Refer to graphic on previous page.
- Forklift access.
- Drive-thru configuration.

## ARCHITECTURAL

- Finishes
  - ~ Floor: Concrete sloped to trench drains.
  - ~ Walls: None.
  - ~ Ceiling: Painted exposed structure or prefinished metal panels.
- Doors
  - ~ None.
- Bollards at each end of island and at fuel dispensers.

## STRUCTURAL

- Control joints in floor slab at adequate spacing.
- Structure as needed to support equipment.

## MECHANICAL

- Heated within the canopy area.
- Natural cross ventilation.

## ELECTRICAL

- Lighting
  - ~ Watertight fixture located between fuel island and centerline of lane.
  - ~ All lighting on emergency power circuit.
  - ~ Explosion proof sealed fixture with diffuser. Refer to Chapter 4 for foot candle and lighting requirements.
- Power
  - ~ Fuel dispensers and submersible pumps on emergency power circuit.
  - ~ Fuel pumps to have emergency shut-off conveniently located in fueling lanes.
  - ~ As required by equipment.
- Communications
  - ~ Paging/intercom system waterproof speakers.
  - ~ Provide signal conduit for fuel management system.

## PLUMBING

- Trench drain perpendicular to bus circulation at either end of fuel lane to oil/water separator.
- Trench drain down the center of the fuel lane.
- Product and vapor recovery piping as required to and from fuel tanks and dispensers.
- As required by equipment.

## Vault Pull / Fare Collection

*(Fuel / Wash / Service)*

### FUNCTION

- Canopy covered drive-thru lanes for vault pull / fare collection operation.

### RELATIONSHIP TO OTHER AREAS

- Shared space with Fueling Position.

### COMMENTS / CHARACTERISTICS

- Furnishings: Remote farebox receiver and probe.
- Utility requirements: Waterproof grounded electrical convenience outlets.
- Floor Finishes: Concrete sloped to trench drains.
- Wall Finishes: None.
- Ceiling Finishes: Painted exposed structure.
- Lighting: Watertight fixture located between fuel island and centerline of lane. All lighting on emergency power circuit. Explosion proof sealed fixture with diffuser. Refer to Chapter 4 for foot candle and lighting requirements.
- Heated within the canopy area.
- Natural cross ventilation.



## Utility Workstation

*(Fuel / Wash / Service)*

See Typical Module 1

### FUNCTION

- Open workstation for the Utility Supervisor and Utility Technicians.

### RELATIONSHIP TO OTHER AREAS

- Near Repair Bays.

### COMMENTS / CHARACTERISTICS

- Furnishings: Refer to module graphic.
- Utility Requirements: Grounded electrical convenience outlets, telephone, intercom/paging system, conduit for network computer system, air conditioned, and heated.
- Floor Finishes: Sealed concrete.
- Wall Finishes: Painted concrete block.
- Ceiling Finish: Painted exposed structure.
- Lighting: Explosion proof sealed fixture with diffuser. Refer to Chapter 4 for foot candle and fixture requirements.
- Define space with 66" high modular office partitions.

## CENTRAL VACUUM

(FUEL / WASH / SERVICE)

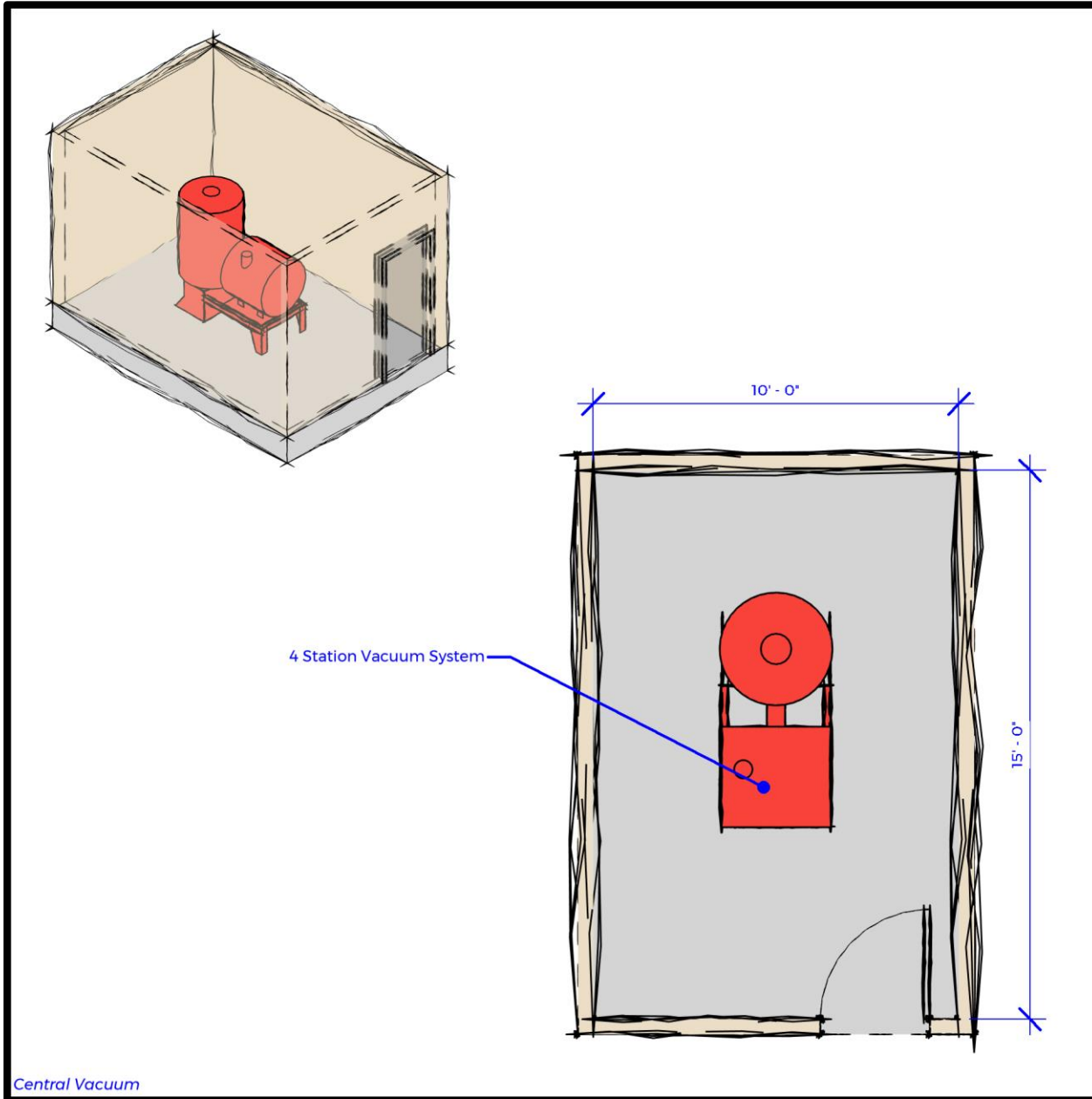

### Function

- Enclosed area for the central vacuum system.

### Relationship to other Areas

- Adjacent to Fueling Positions and Bus Detail Lanes.

### Comments / Characteristics

- Furnishings: Central vacuum system.
- Utility requirements: Grounded electrical convenience outlets and electrical service as required by equipment..
- Floor Finishes: Sealed concrete.
- Wall Finishes: Painted concrete block with insulation.
- Ceiling Finishes: Painted exposed structure.
- Lighting: Service Light Fixture – Utility spaces. Refer to Chapter 4 for foot candle and fixture requirements.
- Acoustically isolated from surrounding areas.
- Vent through roof and expelled above fuel canopies and roofs.
- Positive air pressure to prevent explosive mixture of lighter than air fumes to accumulate in room.

## UNISEX RESTROOM

(FUEL / WASH / SERVICE)

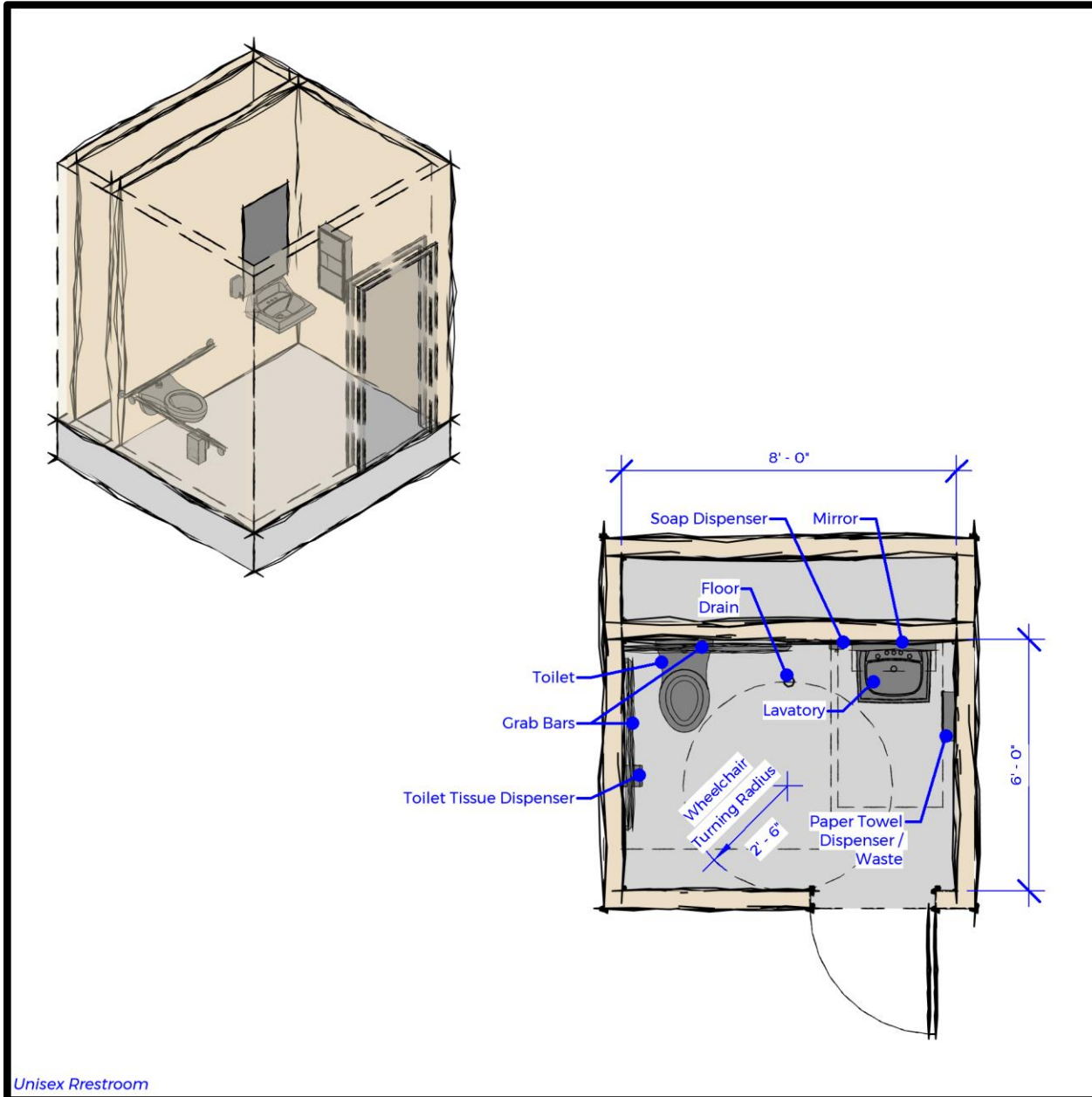

Unisex Restroom

### Function

- Restroom facility for Fueling and Detail Clean staff.

### Relationship to other Areas

- Convenient to Fueling and Detail lanes.

### Comments / Characteristics

- Furnishings: Refer to graphic on this page.
- Utility requirements: Grounded electrical convenience outlets, intercom/paging system, air conditioned, ventilated, and heated.
- Floor Finishes: Porcelain tile.
- Wall Finishes: Paint or porcelain tile on gypsum board.
- Ceiling Finishes: Paint gypsum board.
- Lighting: Wet location sealed fixtures and indirect light over mirror. Refer to Chapter 4 for foot candle and fixture requirements.

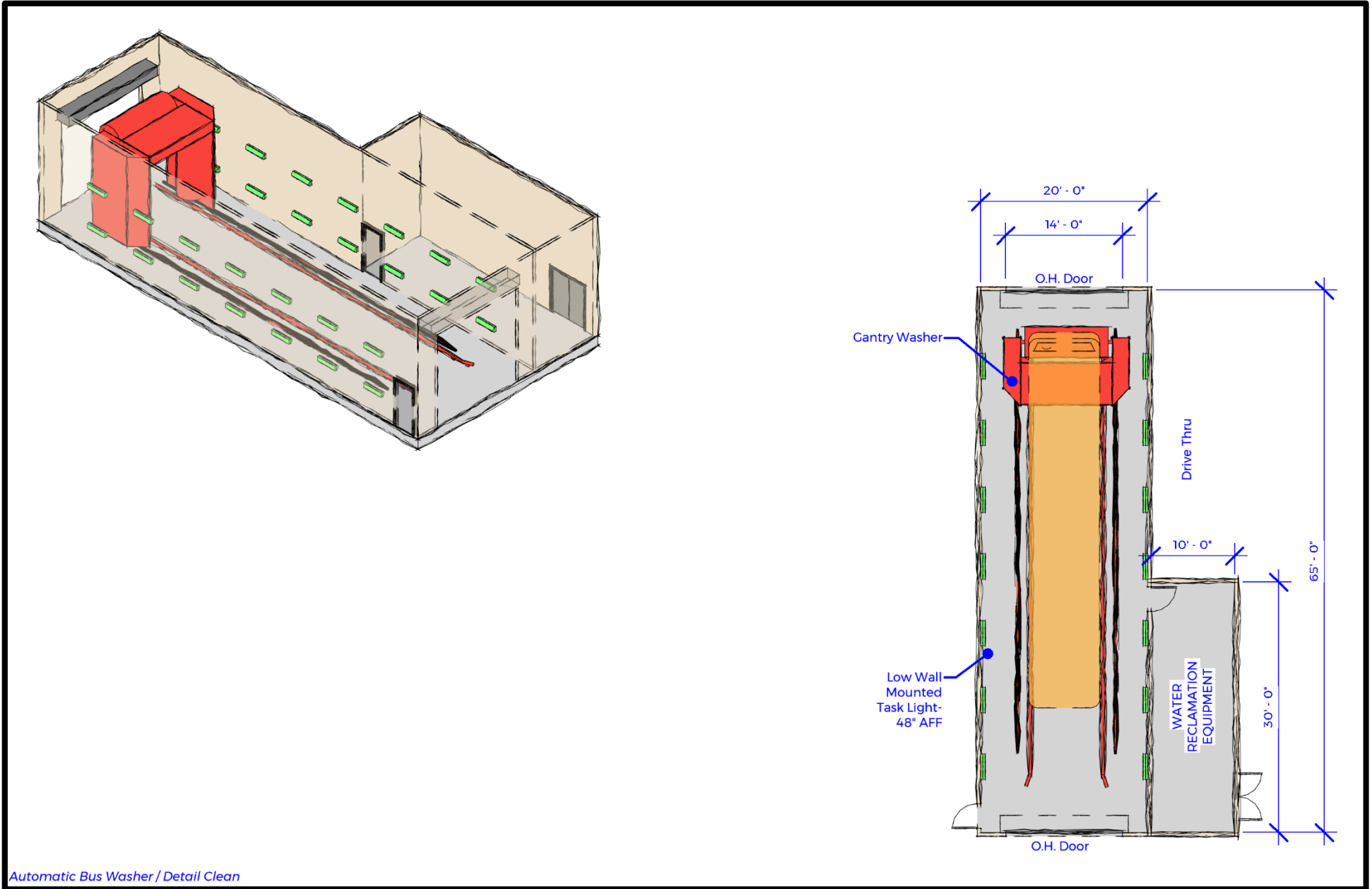

Automatic Bus Washer / Detail Clean

## FUNCTION

- Drive through gantry wash area for the automatic cleaning of vehicle exteriors. Floor space not occupied by gantry washer when wash not in use. Space to be used for secondary covered Detail Clean position.

## RELATIONSHIP TO OTHER AREAS

- Convenient access to/from vehicle parking.
- Efficiently located within site traffic flow.

## CRITICAL DIMENSIONS

- 16'-0" vertical clearance.
- 20'-0" wide by 65'-0" long.

## COMMENTS / CHARACTERISTICS

- Furnishings: Refer to graphic on previous page.
- Drive-thru configuration.

## ARCHITECTURAL

- Finishes
  - ~ Floor: Soil, grease, and water resistant concrete, with integral non-metallic hardener, and clear epoxy sealer. Provide slip resistant finish.
  - ~ Walls: Soil and grease resistant. Epoxy painted to full height.
  - ~ Ceiling: Painted exposed structure.
- Doors
  - ~ Exterior sectional overhead door: 14' x 14' motor operated with interior push button controls, and lockout on exterior.
- Bollards on interior and exterior at jambs of overhead door (2 per door).

## STRUCTURAL

- Control joints in floor slab at adequate spacing.
- All exposed steel galvanized structure as needed to support equipment.

## MECHANICAL

- Heating system must be compatible with possible future use of alternative fueled vehicles.

- Ventilation as required by codes to prevent accumulation of explosive mixtures.
- General ventilation as required by codes.
- As required by equipment.

## ELECTRICAL

- Lighting
  - ~ Waterproof high bay sealed fixture located between wall and centerline of lane. Refer to chapter 4 for foot candle lighting requirements.
  - ~ Task light: Chassis Wash / Detail Clean. Refer to Chapter 4 for foot candle and fixture requirements.
- Power
  - ~ Waterproof duplex receptacles, 120VAC, 20A, GFI protected, on walls at 3'-0" AFF.
  - ~ As required by equipment.
- Communications
  - ~ Watertight paging/intercom system speakers.

## PLUMBING

- Two foot wide and two foot deep drain at mid bay (with removable cover) to water reclaim. Overflow to sediment and oil interceptor.
- 3/4" water hose bib with standard faucet at 4'-0" AFF.
- As required by equipment.

## Water Reclaim

*(Fuel / Wash / Service)*

### FUNCTION

- Dedicated space for water reclaim equipment that serves the bus washer.

### RELATIONSHIP TO OTHER AREAS

- Adjacent Bus Washer.

### COMMENTS / CHARACTERISTICS

- Furnishings: Reclaim equipment to support the Gantry Washer.
- Utility requirements: Waterproof grounded electrical convenience outlets, water and electrical connections as required by equipment.
- Floor Finishes: Soil, grease, and water resistant concrete, with clear epoxy sealer. Provide slip resistant finish.
- Wall Finishes: Epoxy painted concrete block.
- Ceiling Finishes: Painted exposed structure.
- Lighting: Waterproof service light fixture. Refer to Chapter 4 for foot candle and fixture requirements.
- 16'-0" vertical clearance to roof structure.
- Separate from Bus Wash by CMU wall.
- Good ventilation.
- Cast in place or buried separation sumps required.
- Overflow through oil/water separator and then on to sanitary sewer.

## CLEANING STORAGE

(FUEL / WASH / SERVICE)

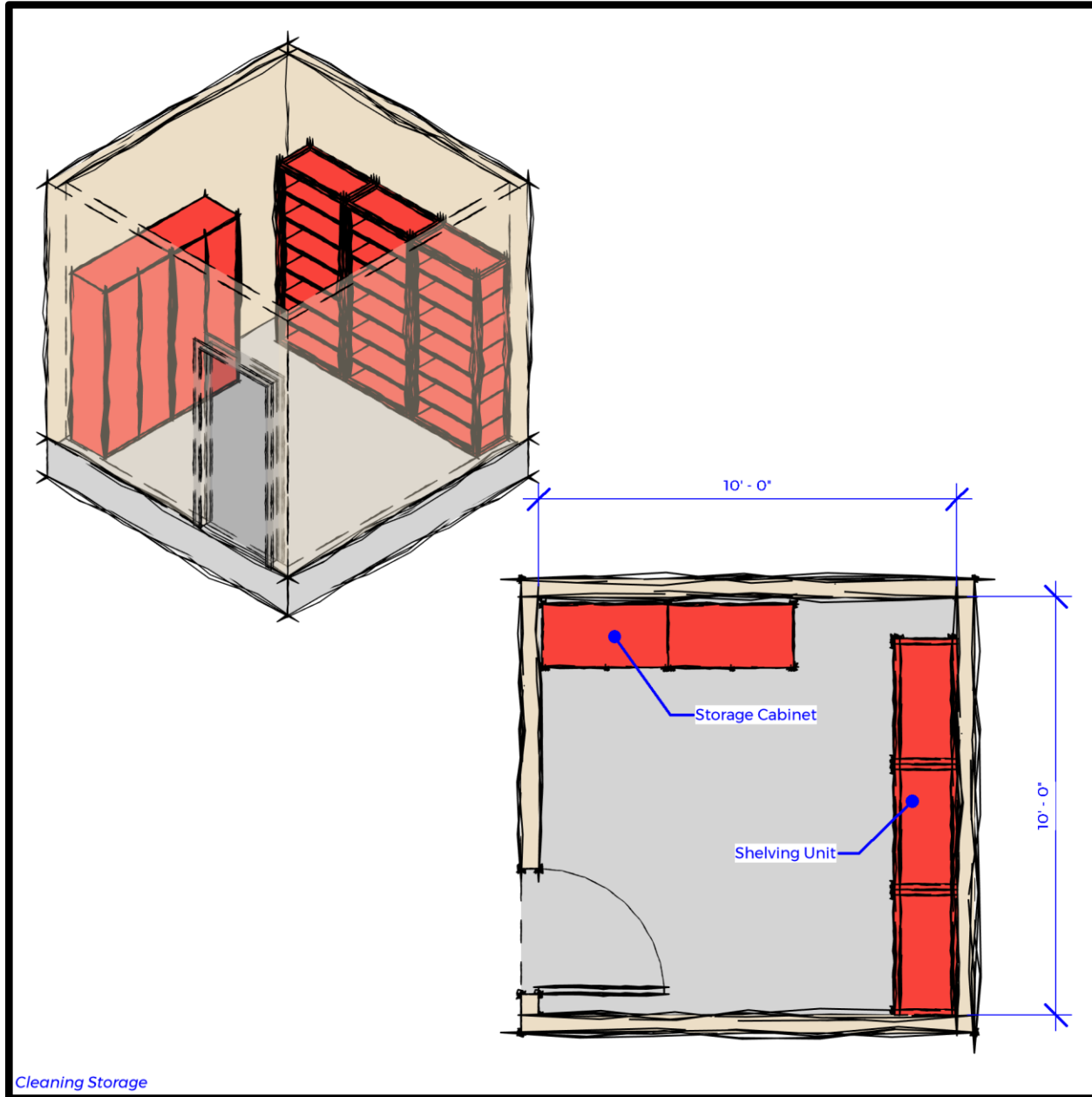

Cleaning Storage

### Function

- Room for storage of cleaning equipment.

### Relationship to other Areas

- Adjacent to Detail Lane positions and Fueling Positions.

### Comments / Characteristics

- Furnishings: Refer to graphic on this page.
- Utility requirements: Grounded electrical convenience outlets, ventilated, and heated.
- Floor Finishes: Soil, grease, and water resistant concrete, with clear epoxy sealer. Provide slip resistant finish.
- Wall Finishes: Epoxy painted concrete block.
- Ceiling Finishes: Painted exposed structure.
- Lighting: Service Light Fixture – Storage rooms. Refer to Chapter 4 for foot candle and fixture requirements.



Chassis Wash

(Fuel / Wash / Service)

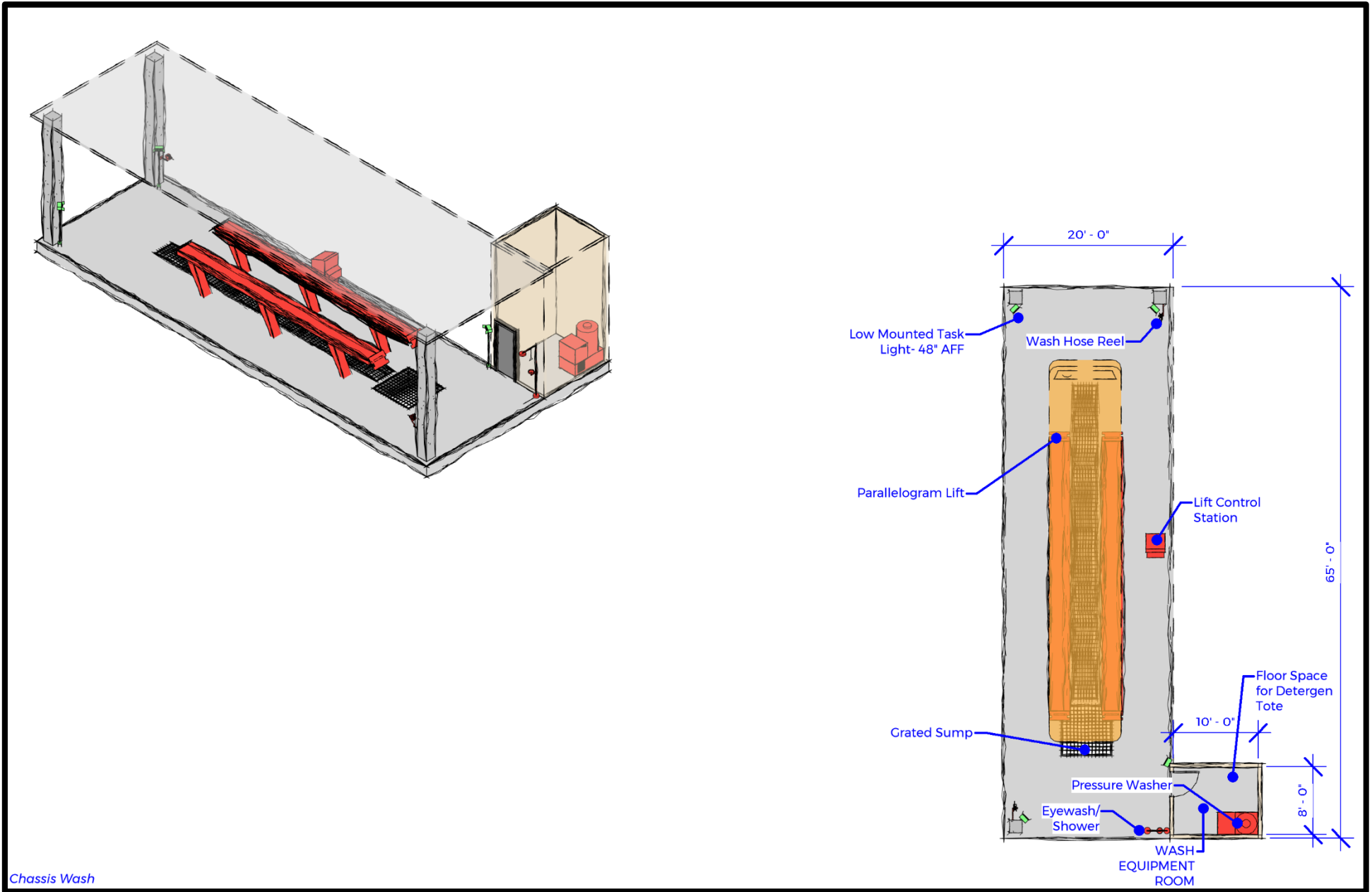

Chassis Wash

## FUNCTION

- Canopy covered area for washing of bus undercarriages, engine compartments, and components.

## RELATIONSHIP TO OTHER AREAS

- Convenient access to Repair Bays.

## CRITICAL DIMENSIONS

- 21'-0" vertical clearance.
- 20'-0" wide by 65'-0" long.

## COMMENTS / CHARACTERISTICS

- Furnishings: Refer to graphics on previous page.

## ARCHITECTURAL

- Finishes
  - ~ Floor: Soil, grease, and water resistant concrete, with integral non-metallic hardener, and clear epoxy sealer. Provide slip resistant finish.
  - ~ Walls: Painted steel columns.
  - ~ Ceiling: Painted exposed structure.
- Doors
  - ~ None.
- Bollards at each end of canopy at columns and building exterior corners.

## STRUCTURAL

- Control joints in floor slab at adequate spacing.
- Structure as needed to support equipment.

## MECHANICAL

- Heated and ventilated area within the canopy structure.

## ELECTRICAL

- Lighting

- ~ Waterproof high bay sealed fixture located between wall and centerline of lane. Refer to chapter 4 for foot candle lighting requirements.
- ~ Task light: Chassis Wash / Detail Clean. Refer to Chapter 4 for foot candle and fixture requirements.
- Power
  - ~ Waterproof duplex receptacles, 120VAC, 20A, GFI protected, on walls at 3'-0" AFF.
  - ~ As required by equipment.
- Communications
  - ~ Watertight paging/intercom system speakers.

## PLUMBING

- 3/4" water hose bib with standard faucet at 4'-0" AFF.
- Compressed air line with cut-off valve, filter, regulator with gauge, lubricator, cleanout valve, and quick disconnects at 4'-0" AFF. Provide disconnects for 1/2" and 1" impact tools at locations to be determined during detailed design.
- As required by equipment.

## Chassis Wash Equipment

*(Fuel / Wash / Service)*

### FUNCTION

- Enclosed area for the high pressure / hot water washer

### RELATIONSHIP TO OTHER AREAS

- Adjacent to Chassis Wash.

### COMMENTS / CHARACTERISTICS

- Furnishings: High pressure hot water washer.
- Utility requirements: Grounded electrical convenience outlets, water, drain, natural gas, and heated.
- Floor Finishes: Soil, grease, and water resistant concrete, with clear epoxy sealer. Provide slip resistant finish.
- Wall Finishes: Epoxy painted concrete block. Full walls.
- Ceiling Finishes: Painted exposed structure.
- Lighting: Wet location sealed light fixture. Refer to Chapter 4 for foot candle and fixture requirements.

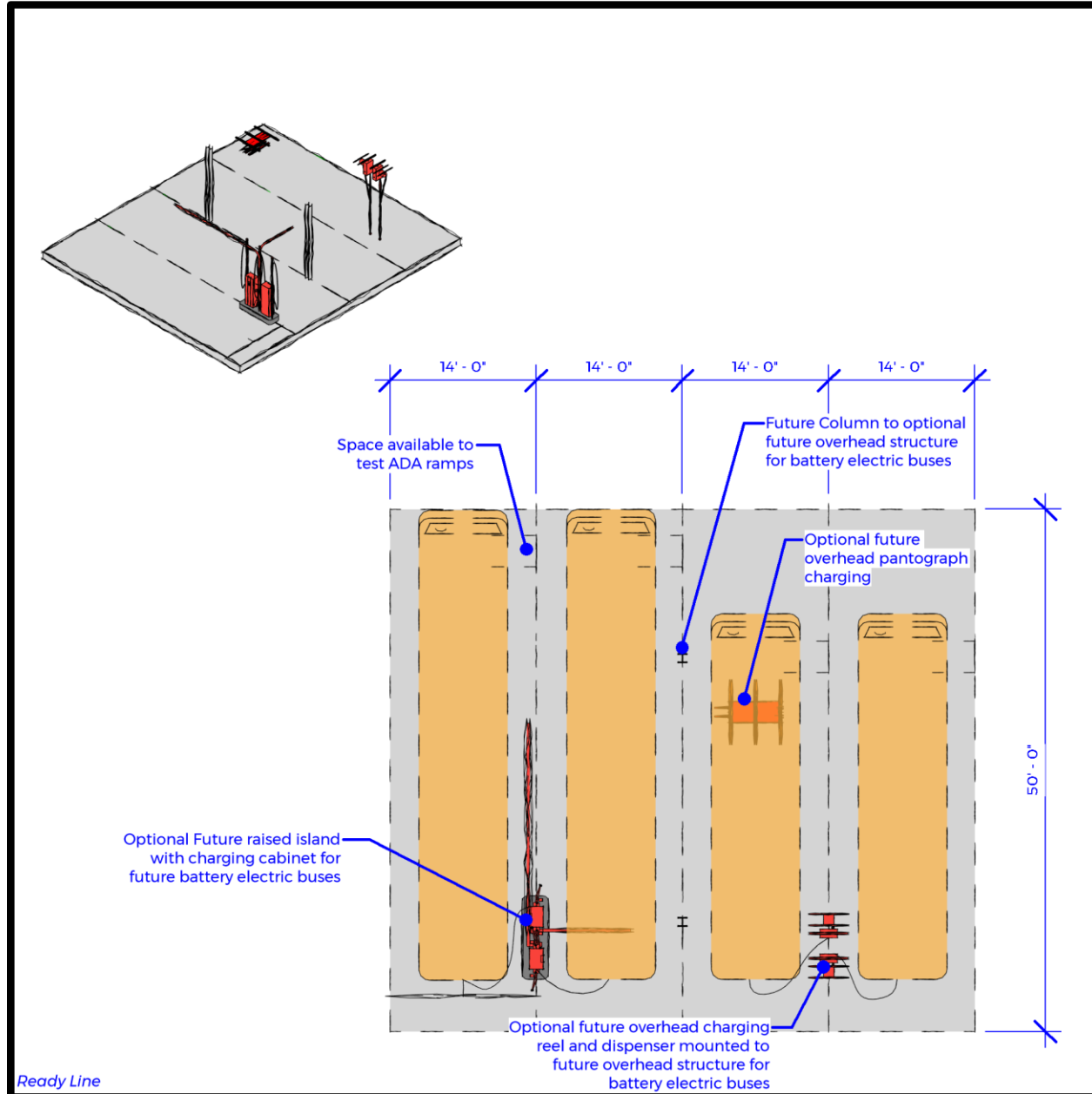

**Function**

- Designated area for 25 foot, 35 foot, and 45 foot buses ready for service.

**Relationship to other Areas**

- Located to optimize vehicle and pedestrian traffic flows.

**Comments / Characteristics**

- Furnishings: None.
- Utility requirements: Intercom/paging system.
- Floor Finishes: Concrete or asphalt paving.
- Wall Finishes: None.
- Ceiling Finishes: None.
- Lighting: Site lighting fixture – agency vehicle parking. Refer to Chapter 4 for foot candle and fixture requirements.
- Parking spaces should be numbered. Numbering system should be coordinated with agency.
- Parking spaces should be 14' x 50' for 45 foot buses.
- Parking spaces should be 14' x 40' for 35 foot buses.
- Parking spaces should be 14' x 30' for 25 foot buses.
- Option = 12' wide as fleet grows.
- NOTE: 14'-0" wide parking spaces allow for in-place testing of bus ADA ramps.
- NOTE: 14'-0" wide parking spaces allow for overhead electric bus charging support structure or in pavement charging.

Ready Line

## Non-Revenue Vehicles

*(Agency Vehicle Parking)*

### FUNCTION

- Designated area for non-revenue vehicles.

### RELATIONSHIP TO OTHER AREAS

- Located to optimize vehicle and pedestrian traffic flows.

### COMMENTS / CHARACTERISTICS

- Furnishings: None.
- Utility Requirements: Intercom/paging system.
- Floor Finishes: Asphalt or concrete.
- Wall Finishes: None.
- Ceiling Finishes: None.
- Lighting: Site lighting fixture – Agency Vehicle parking, circulation, and Agency Service areas. Refer to Chapter 4 for foot candle and fixture requirements.
- Parking rows (columns) to be numbered with painted graphics.
- Wireless network accessible.

## Down Line

*(Agency Vehicle Parking)*

### FUNCTION

- Designated area for buses and shuttles waiting for maintenance.

### RELATIONSHIP TO OTHER AREAS

- Located to optimize vehicle and pedestrian traffic flows.
- Accessible to Repair Bays.

### COMMENTS / CHARACTERISTICS

- Furnishings: None.
- Utility Requirements: Intercom/paging system.
- Floor Finishes: Concrete.
- Wall Finishes: None.
- Ceiling Finishes: None.
- Lighting: Site lighting fixture – Agency Vehicle parking, circulation, and Agency Service areas. Refer to Chapter 4 for foot candle and fixture requirements.
- Parking rows (columns) to be numbered with painted graphics.
- Wireless network accessible.

## Employee Parking

*(Employee / Visitor Parking)*

### FUNCTION

- Designated outdoor area for employee vehicles.

### RELATIONSHIP TO OTHER AREAS

- Located to optimize vehicle and pedestrian traffic flows.

### COMMENTS / CHARACTERISTICS

- Furnishings: None.
- Utility Requirements: Intercom/paging system.
- Floor Finishes: Concrete or asphalt.
- Wall Finishes: None.
- Ceiling Finishes: None.
- Lighting: Site lighting fixture – Yard Storage, Employee and other parking and circulation areas. Refer to Chapter 4 for foot candle and fixture requirements.

## Visitor Parking

*(Employee / Visitor Parking)*

### FUNCTION

- Designated outdoor parking area for visitors.

### RELATIONSHIP TO OTHER AREAS

- Located to optimize vehicle and pedestrian traffic flows.

### COMMENTS / CHARACTERISTICS

- Furnishings: None.
- Utility Requirements: Intercom/paging system.
- Floor Finishes: Concrete or asphalt.
- Wall Finishes: None.
- Ceiling Finishes: None.
- Lighting: Site lighting fixture – Yard Storage, Employee and other parking and circulation areas. Refer to Chapter 4 for foot candle and fixture requirements.

## Motorcycle Parking

*(Employee / Visitor Parking)*

### FUNCTION

- Designated parking area for motorcycles.

### RELATIONSHIP TO OTHER AREAS

- Located to optimize vehicle and pedestrian traffic flows.

### COMMENTS / CHARACTERISTICS

- Furnishings: None.
- Utility Requirements: Intercom/paging system.
- Floor Finishes: Concrete.
- Wall Finishes: None.
- Ceiling Finishes: None.
- Lighting: Site lighting fixture – Yard Storage, Employee and other parking and circulation areas. Refer to Chapter 4 for foot candle and fixture requirements.

## Bicycle Parking

*(Employee / Visitor Parking)*

### FUNCTION

- Designated area for parking bikes.

### RELATIONSHIP TO OTHER AREAS

- Located to optimize vehicle and pedestrian traffic flows.

### COMMENTS / CHARACTERISTICS

- Furnishings: Bicycle rack.
- Utility Requirements: Intercom/paging system.
- Floor Finishes: Asphalt or concrete.
- Wall Finishes: None.
- Ceiling Finishes: None.
- Lighting: Site lighting fixture – Yard Storage, Employee and other parking and circulation areas. Refer to Chapter 4 for foot candle and fixture requirements.



## OUTDOOR BREAK AREA

(OTHER SITE AREAS)

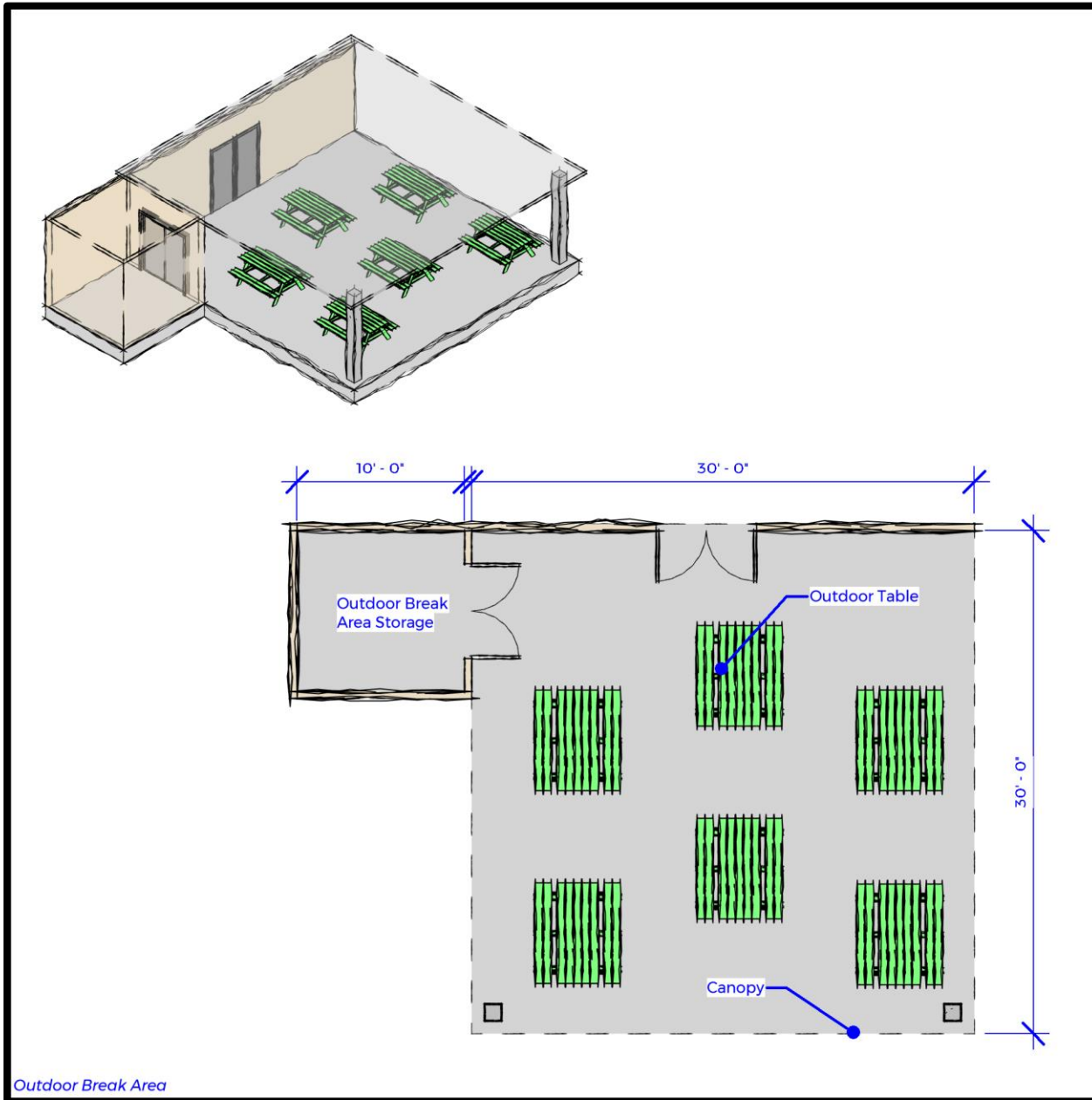

### Function

- Outdoor canopy covered area for breaks.

### Relationship to other Areas

- Convenient access to all departments.

### Comments / Characteristics

- Furnishings: BBQ pit and picnic tables.
- Utility requirements: Waterproof grounded electrical convenience outlets.
- Floor Finishes: Broom finished concrete.
- Wall Finishes: None.
- Ceiling Finishes: Painted exposed canopy structure.
- Lighting: Wet location sealed fixture with diffuser. Refer to Chapter 4 for foot candle and fixture requirements.

## Above Ground Diesel Tank

*(Other Site Areas)*

### FUNCTION

- Designated area for tank for storage of diesel fuel to provide fueling of diesel vehicles.

### RELATIONSHIP TO OTHER AREAS

- Adjacent to the bus parking area to reduce piping runs.

### COMMENTS / CHARACTERISTICS

- Specific requirements to be determined during design.

## Building Back-Up Generator

*(Other Site Areas)*

### FUNCTION

- Designated area for back-up generator to support building systems.

### RELATIONSHIP TO OTHER AREAS

- Adjacent to the bus parking area to reduce conduit runs and minimize power loss to charging units.

### COMMENTS / CHARACTERISTICS

- Specific requirements to be determined during design.

## Future Hydrogen Pre-Comp. Modular Trailers

*(Other Site Areas)*

### FUNCTION

- Designated area for Hydrogen Pre-Compressor Hydrogen Modular Trailers for fueling of Hydrogen vehicles.

### RELATIONSHIP TO OTHER AREAS

- Adjacent to the bus parking area to reduce piping runs.

### COMMENTS / CHARACTERISTICS

- Specific requirements to be determined during design.
- 480 VAC 3 Phase power with disconnect and water proof plug receptacle.

## Future Hydrogen Electrolizer Modular Trailers

*(Other Site Areas)*

### FUNCTION

- Designated area for Hydrogen Electrolizer Modular Trailers to produce Hydrogen for fueling Hydrogen vehicles.

### RELATIONSHIP TO OTHER AREAS

- Adjacent to the Future Hydrogen Compressor Yard to reduce piping runs.

### COMMENTS / CHARACTERISTICS

- Specific requirements to be determined during design.
- 480 VAC 3 Phase power with disconnect and water proof plug receptacle.

## Future Hydrogen Compressor Yard

*(Other Site Areas)*

### FUNCTION

- Designated area for Hydrogen Compressor to support fueling Hydrogen vehicles.

### RELATIONSHIP TO OTHER AREAS

- Adjacent to the bus parking area to reduce piping runs.

### COMMENTS / CHARACTERISTICS

- Specific requirements to be determined during design.

## BEB Charge Equipment Yard

*(Other Site Areas)*

### FUNCTION

- Designated area for electrical equipment including transformers and switchgear to support the charging of battery electric buses (BEBs).

### RELATIONSHIP TO OTHER AREAS

- Adjacent to the bus parking area to reduce conduit runs and minimize power loss to charging units.

### COMMENTS / CHARACTERISTICS

- Specific requirements to be determined during design.
- BEB charger equipment layout types to be reviewed during conceptual layout workshop.

## BEB Charging Back-Up Generator

*(Other Site Areas)*

### FUNCTION

- Designated area for back-up generator for BEB charging of fleet of ready for pull out buses.

### RELATIONSHIP TO OTHER AREAS

- Adjacent to the bus parking area to reduce piping runs.

### COMMENTS / CHARACTERISTICS

- Specific requirements to be determined during concept design and based on available site fuels.

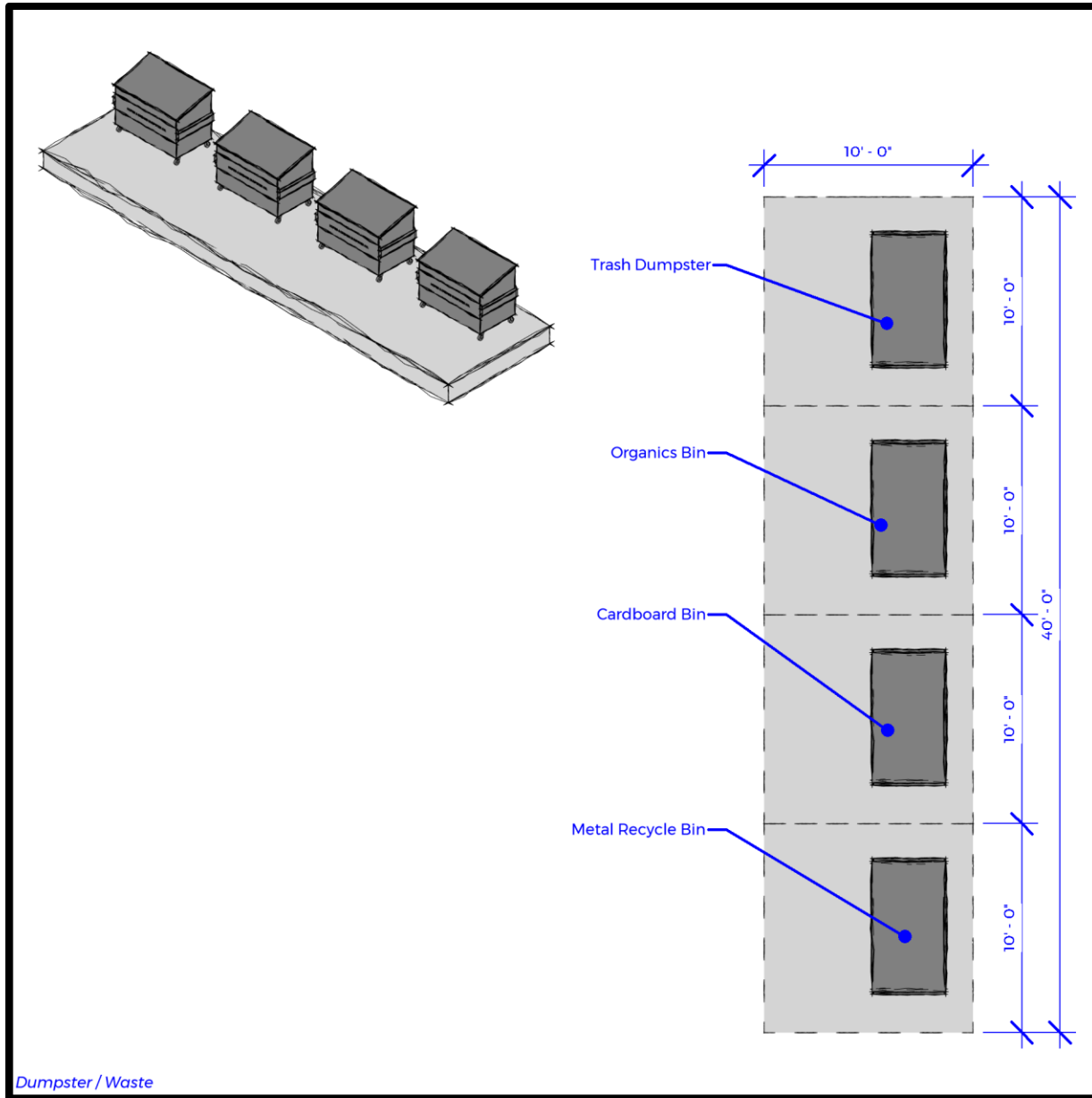

Dumpster / Waste

**DUMPSTER / WASTE** (OTHER SITE AREAS)

**Function**

- Designated area for staging of dumpsters / recycling bins.

**Relationship to other Areas**

- Located to optimize vehicle and pedestrian traffic flows.

**Comments / Characteristics**

- Furnishings: Refer to graphic on this page.
- Canopy covered.
- Utility Requirements: None.
- Floor Finishes: Concrete.
- Wall Finishes: None.
- Lighting: Site lighting fixture – Agency Vehicle parking, circulation, and Agency Service areas. Refer to Chapter 4 for foot candle and fixture requirements

# ELECTRICAL SERVICE APPROACH

## GOALS

Fleet conversion to battery-electric buses requires a great deal of power to charge the vehicles. The relationship between the transit agency and the distribution utility changes because the utility is more like a fuel provider. If buses cannot fuel after a day of service, the buses are not able to run the next day. Similarly, with battery electric buses (BEBs), if there is a power outage, it could have a substantial impact on the next day's rollouts. This means that the power coming from the utility needs to be reliable and the grid needs to be able to support the increased load that BEBs require. This section will discuss how the distribution utility, PG&E, can supply sufficient power, reliably, and discuss resiliency options if there is a power outage.

## UTILITY RELIABILITY

The Next Generation Transit Facility will be new construction on a yet undetermined site. As described below there are a number of factors to determine the reliability of power at a specific site. Site / address specific historic utility reliability data can be generated but only after the electrical service on a specific site has been installed and enough time has elapsed to collect data. For sites without an existing power service or historic data, regional reliability data can be used to forecast reliability. Yuba and Sutter counties are both served by PG&E and both fall within the PG&E's Sacramento Division. The reliability indices listed below are specific to this PG&E Sacramento Division and hence will apply to all potential Next Generation sites within this study.

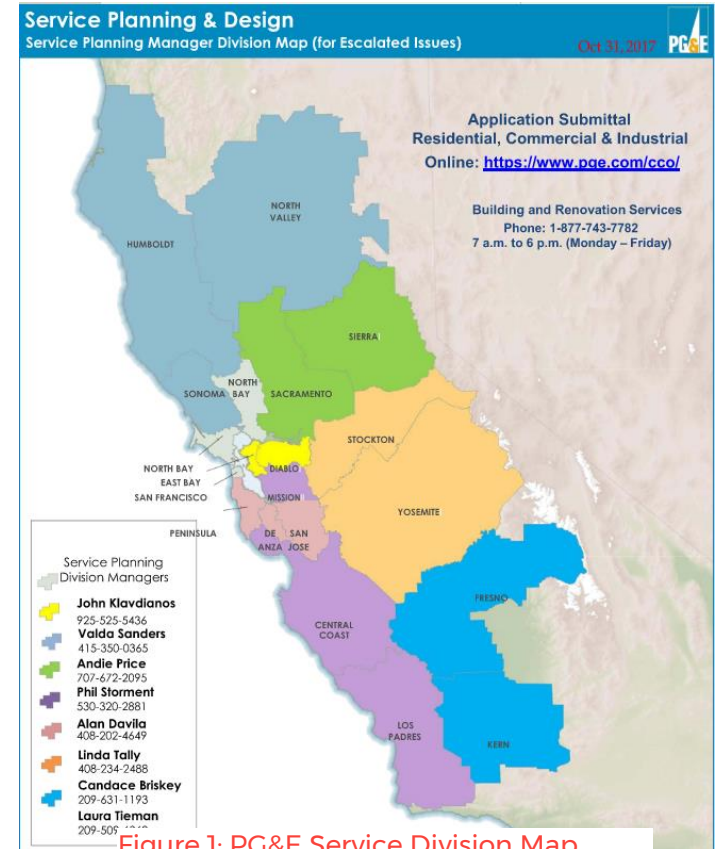

Figure 1: PG&E Service Division Map

## Reliability Indices

Power reliability is an important factor when considering the transition to BEBs. Without an understanding of existing reliability or measures in place to mitigate the risks of an outage, any disruption in electrical flows can be devastating to Yuba-Sutter Transit’s service.

- The California Public Utilities Commission (CPUC) monitors reliability for regulated, investor-owned utilities around the State to ensure that performance is upheld. Information was gathered from the CPUC (see Table 1 and Figure E.2) as it relates to Pacific Gas & Electric (PG&E), the local distribution utility.

**Table 1: Electric Power Distribution Reliability Indices**

INDEX	MEASURE	UNITS
System Average Interruption Duration Index (SAIDI)	Average outage duration per customer	Minutes per outage (per customer)
System Average Interruption Frequency Index (SAIFI)	How often a customer can expect to experience an outage	Number of outages a year (average)
Momentary Average Interruption Frequency Index (MAIFI)	The frequency of momentary interruptions	Number of instantaneous outages per year (average)
Customer Average Interruption Duration Index (CAIDI)	Average outage duration if an outage is experienced, or average restoration time	Minutes Per Year (per customer)

Source: CPUC



## PG&E Reliability

Reliability metrics can vary from year to year based on large power outage events, such as the Camp in Paradise, California in 2018, or the Southwest Blackout of 2011. Therefore, CPUC generally uses 10-year rolling averages to show improvements over time. After Pacific Gas & Electric’s transmission lines caused the deadliest fire in California history (the Camp Fire), the CPUC and regulated utilities began to implement public safety power shutoffs (PSPS) in 2019. The resulting harm to PG&E’s reliability has not been publicly reported yet. While the potential Next Generation sites area all located outside of the CPUC wildfire zones of California, it relies on transmission lines that cross the wildfire zones which is a risk to the sites. PG&E reliability in the Sacramento service division shows an increasing frequency of power outages with a slight decrease in duration of outages.

For all four metrics shown in Table 2 lower numbers indicate more reliability, higher numbers less reliability. For example, if an average outage duration (CAIDI) is experienced, the number represents the number of minutes of the outage, so an outage of only 45 minutes shows a more robust system than an average outage of 90 minutes. The results show that Sacramento Division’s performance is about average for California.

An example of the listed causes for the higher than average SAIFI numbers included a 2018 March 1 storm with heavy winds and rain. This one weather event contributed to 0.024 PG&E’s customer-interruptions to the division’s SAIFI performance. Example of MAIFI interruptions included late December 2018 storm events over an eight-day period that contributed to 0.080 customer-interruptions to the division’s SAIFI performance.

Based on the latest historic 5-year average, each customer, or future customer, within PG&E’s Sacramento district can expect just under one power outage per year, and it will last approximately 113 minutes. (By multiplying 0.911 average outages per year \* 103.6 minutes per outage = 94.5 minutes of average outage minutes per year). Similarly, there are 1.5 momentary outages per customer per year. This is about average for all Investor Owned Utility (IOU) Divisions within California and may be an acceptable risk for Yuba Sutter Transit.

There are other ways to get additional reliability from PG&E, including redundant feeders. This may be a cheaper way to achieve a similar level of reliability.

Table 2: PG&E Service Division Metrics Fire

### Sacramento Division Performance

Division / System	Year	SAIDI	SAIFI	MAIFI	CAIDI
SACRAMENTO	2013	93.0	0.937	1.566	99.2
SACRAMENTO	2014	94.4	0.807	1.258	117.0
SACRAMENTO	2015	80.1	0.799	1.556	100.3
SACRAMENTO	2016	83.6	0.944	1.539	88.5
SACRAMENTO	2017	121.2	1.070	1.772	113.2
5-Year Average	13-17 Avg	94.5	0.911	1.538	103.6
SACRAMENTO	2018	101.0	1.021	1.887	98.9
	%Difference	7.0%	12.0%	22.7%	-4.6%

Source: CPUC

**ANTICIPATED MAXIMUM POWER REQUIREMENTS FOR DAILY BEB CHARGING**

**Fleet and BEB Charging Assumptions**

By 2040, Yuba-Sutter Transit is anticipating a 100% zero emission bus (ZEB) fleet. Zero emission vehicles can be either a battery electric bus (BEB), hydrogen fuel cell electric vehicle (FCEV) or an electric trolley run from DC powered overhead catenary (wire) system. Electric trolleys were eliminated as a potential viable vehicle option for the Next Gen Facility and the Next Gen Facility Space Needs Program listed three potential ZEB configurations:

- 100% Hydrogen Fuel Cell Electric Vehicle Fleet
- 100% Battery Electric Bus Fleet
- Mixture of both FCEV and BEBs

A full 100% BEB fleet will generate the maximum power usage at the site so the following calculation of the Anticipated Maximum Power Requirements for daily BEB charging is provided as a worst-case power usage scenario where all the revenue vehicles are charged in designated nightly parking spaces. Note that there are numerous and common ways to reduce this worst-case power requirement including:

**Table 3:Maximum Power Requirement – BEB Charging**

- Utilizing charge management software to keep below a set power usage limit (most common and important strategy)
- Utilizing single chargers to charge multiple buses (this also reduces capital expenditures and is chosen by most transit agencies)
- Not charging the Down Line buses
- Generating power on site from solar and / or wind, with stationary batteries to store power and smooth peaks
- Staggered charging times as buses are connected to chargers as they enter the site over nightly pulling charging time

VEHICLE	QTY	CHARGER CAPACITY	FULLY LOADED OUTPUT @ 1:1 CHARGER:DISPENSER RATIO
45 Foot Transit Commuter	22	150 Kw	3.3 MW
35 Foot Transit Coaches	28	150 Kw	4.2 MW
24-25 Foot Shuttle	20	150 Kw	3.0 MW
	<b>70</b>		<b>10.5 MW</b>

Additionally, the rating of a BEB charger is its maximum output and in practice a charger will deliver a lower range of power over a single charging cycle with the power varying based on multiple factors including battery temperatures, state of charge, and battery chemistry. The amount of power drawn from a charger is controlled by the specific battery charge controller on the specific bus to which it is connected. By assuming full output from the chargers as if every charger would be fully utilized at the same time, the maximum worst-case power amount generated by calculation will be substantially more than power anticipated to be used. Table E.2 indicates the 2040 fleet breakdown and anticipated charger capacity and total maximum worst-case scenario power requirement to support that fleet.

## BACKUP GENERATOR REQUIREMENTS

### Emergency Engines

One option in the event of a power outage is to size and install back up power generation from a traditional fossil fueled generator. This may be the most economical option, especially if existing fuel sources of diesel and natural gas are already present on site, and/or if existing backup generators can be repurposed. However, generator lifetime costs and reporting costs add up quickly so careful analysis should be done on these options.

Internal combustion emergency engines (either Diesel or natural gas) >25 brake horsepower are subject to air quality permitting through the Feather River Air Quality District (FRAQMD) prior to construction in either Yuba or Sutter county. Properly sizing a generator and its needs can be complex based on other Distributed Energy Resources, Bus Route Modeling, and Charge Management Modeling. However, a rough estimate of a 380 kW generator is about \$400,000 for just the generator itself. Assuming a 174 kW peak load for a charger, this could theoretically power two (2) 150kW charging positions to charge 12 electric buses by cycling a bus onto the charger as each previous bus finished the charging process over a day if run constantly. Alternately, a 1.5 MW generator would cost roughly \$1.1M and could power eight (8) 150kW charging positions simultaneously to much more quickly cycle the same 12 (or more) buses in an emergency situation. Additional input from battery and/or solar panels would augment this capability with the right microgrid controls to coordinate activities.

### Operating Restrictions

An emergency engine is intended to operate in the event the primary energy supply is disrupted or discontinued during outages and disaster outside the control of the owner or operator of the emergency engine. Federal regulations allow operations for non-emergency purposes up to 100 hours per calendar year. CARB and FRAQMD limits future non-emergency operation per calendar year, based on generator specifications, unless FRAQMD provides written authorization to exceed the limit. Engines that operate more than 200 hours per year are subject to additional emission, monitoring, inspection, and stack testing requirements. All operation is subject to record-keeping which documents the purpose and duration of operation as measured by the non-resettable hour meter. Note however that CARB allows for unlimited generator usage during an emergency outage situation and has recently confirmed that a planned shutdown / Public Safety Power Shutoff (PSPS) is an emergency.

### Emission Considerations

All emergency engines manufactured on or after January 1, 2009 are required to meet emission limits by design or with an emission control device such as a catalyst. Further, CARB and FRAQMD may require emergency engines, depending on generator specifications, operating more than 200 hours per year to reduce emissions of nitrogen oxide (NOx), carbon monoxide, and volatile organic compounds (VOC). Emissions are verified by stack testing initially for engines subject to Federal standards and every 24 months for those subject to FRAQMD emission limitations.

### Reporting Considerations

Emergency engines are required to perform annual maintenance or more frequently based on hours of operation. Based on generator specifications, emergency engines are required by FRAQMD to conduct inspections periodically and to monitor exhaust characteristics of the engine. All inspection, monitoring, and maintenance is subject to recordkeeping of the measurement or occurrence of the event.

### Summary

The requirement threshold for air quality monitoring is any unit with approximately 50 bhp which is roughly a 150-kW generator. Any new generator for this effort, even if it just supports an initial limited bus deployment of 12 BEBs, would likely need to be larger than this and subsequently would require it to be monitored and total runtime would be limited. The cost-benefit analysis of this must be done while considering what realistic resiliency needs are.

### STATIONARY BATTERY ENERGY STORAGE

Stationary batteries are not an alternative energy source, but instead are simply a mechanism to store electrical energy. Batteries can be used to avoid peak demand charges by storing energy during times of low usage and discharging during peak usage times. Batteries do not currently qualify for any federal incentive programs but can be paired with solar to be eligible for the Investment Tax Credit (ITC). The ITC is valued at 22% during 2021, and 10% after 2022.

### Benefits

Batteries can help achieve a lower utility category. For example, PG&E requires additional customer requirements for connections larger than 10MW. When coordinated with the utility, a battery can be used to consume more than 10MW for short durations.

There is potential to use stationary batteries as a source of revenue to Yuba-Sutter Transit. Batteries can respond to changing conditions very rapidly and can participate in frequency response or ramping markets. Yuba-Sutter Transit might be able to use the stationary batteries during the day to participate in these markets, while then using the batteries to charge the battery electric bus fleet at night.

Stationary battery energy storage requirements are usually less onerous than the requirements for batteries used for transportation (like battery electric buses). It is expected that in the next 10 years, a large secondary market will become available for buying used vehicle batteries and using them for stationary applications..

## Drawbacks

Batteries are expensive but costs have been coming down every year. The costs of batteries heavily depend on the amount of energy to be stored, so short duration batteries are more cost effective than long duration.

Batteries take up valuable real estate, though they could be raised onto supporting steel since they have no moving parts.

There are energy losses in converting energy for storage and back again to grid power. This penalty is usually ~20%.

Additionally, battery capacity reduces overtime, and eventually will hold insufficient charge and will need to be replaced and recycled. Proper disposal or recycling of end of life batteries can be very costly and hazardous if not done correctly. While there are many suggested cases of “second-life” uses of degraded batteries, this is still largely a complex and unknown industry issue, both for stationary storage and batteries in vehicles.

## Examples and Sizes of Stationary Batteries

If the first phase of the Next Gen Facility project would include 5 battery electric buses at an estimated 360 kWh battery per bus (current Van Hool 45ft coach battery size). If each bus needs 80% charge to complete its route, that is a total of 1,440 kWh of energy needed. Stationary Batteries often come in shipping container sizes and each 20' shipping container can hold around 2MWH, depending on brand. Yuba-Sutter Transit could install one to provide enough load to fully charge the 5 buses in the event of a total power outage. During blue sky days, the battery could be used to earn revenues through resource adequacy contracts and arbitrage fluctuating energy costs. However, the cost would be around \$2M for this installation without solar or tax credits.

## DETERMINING RESILIENCY NEEDS

There are many different ways to add resiliency besides those listed above as solar panels, battery storage, backup generators, redundant power feeds, microgrids, are all options. With enough space, time, and money, almost any amount of resiliency is achievable, but at what cost? It is important to integrate needs for resiliency into the overall resiliency effort and planning. The first stage of the resiliency is to be able to support fully charging limited fleet of initial BEBs to full in the event of a power outage. During early fleet transition, the existing conventional fleet can provide backup for BEBs. As the BEB fleet gets closer to 50% or more of the fleet, having resiliency for charging becomes critical for maintaining a full fleet pull out. For a full 100% BEB fleet, charging multiple BEBs to full has a much more substantial cost, and further analysis can help determine the most cost-effective way of providing resiliency. There are two main aspects that adding these technologies can help with:

- 1) Reducing overall operational/electricity cost.
- 2) Ensuring backup power exists to meet a certain rollout time in the event of an outage.

Both of these items require further analysis of the demands of the BEB network, the resiliency of the utility, and the level of comfortability that the transit authority has for estimating those needs. The Reliability statistics in section 1 are a great place to start, especially for determining how much backup power a depot really needs. For the assumed example of an initial 5 BEB fleet, there are probably enough diesel buses to fill any gaps in service if there is an outage, but as those get phased out and the fleet is converted to all electric, what happens if there is an outage overnight and all of the chargers go down?

To determine this, modeling needs to be done to estimate the amount of time the BEBs will need to charge versus the time they are at the depot. It is possible that some buses may come in close to empty that require substantially more charge time, whereas some buses may come in at 40% or more battery power. Therefore, it is important to measure what the average differential in time sitting at the depot versus time charging really is. From there, you can look at the resiliency statistics for the area to determine what the impact of an anticipated power outage would be.

For example, the CAIDI statistic, which is the average number of minutes the power is down when there is an outage, can help determine the gap that you need to cover. For the potential Yuba-Sutter Transit Next Gen Facility sites, the average outage is 104 minutes (1 hour and 44 minutes). When looking at fleet times, you then want to see what percentage of your buses would not be able to charge enough to complete their routes if an outage lasted that long, or some multiple of that amount based on Yuba-Sutter Transit Operation's comfort level with those statistics and their effects if a rollout is not achieved. If only 5% of buses wouldn't be able to charge to full capacity if the power was out for nearly 2 hours, it might not be a concern and little to no back up may be required. However, if something like 50% of buses would not be able to complete their routes if the power went out for less than two hours, then that is a much bigger concern and substantial investment in alternative generation and storage technologies could be critical.

To help look at electricity cost, you can also use microgrid technologies that would allow you to achieve the same level of resilience while paying less for electricity every month. PG&E has rates that change based on when the electricity is used, so if there are some buses that need to charge during peak times, using something like solar + battery storage to charge those buses could substantially decrease that operational cost.

## Hydrogen Service Approach

The single most pragmatic limitation for either a mixed or full hydrogen FCEV is the availability and cost of the hydrogen itself. During the Next Gen Site evaluation, no local source of available hydrogen was found. Gas vendors like Air Liquide and Airgas can be contracted to bring in hydrogen similar to how diesel is trucked in now, but with the hydrogen source being from outside of Yuba or Sutter counties.

Modular portable ‘trailer’ size hydrogen generation and compression units are available but have limited capacities. A single 12 ft x 50 ft compression trailer will be capable of filling approximately two (2) 45-foot buses from empty. If FCEV are used sparingly as a range extender for long routes, a smaller fleet of 2 to 6 FCEV may suffice for Operations and the capital tradeoff of the cost of the compressor container module could be validated.

A larger fixed compression and hydrogen storage yard can be constructed on the top ranked Sites 3 and 7, which have adequate land to build a fixed compression station. While site 12 would have enough land for a larger fixed compression and hydrogen storage yard if both available parcels were included, however the adjacency to buildings and road ways would make it more challenging to successfully accommodate a fixed full fleet hydrogen yard.

As per NFPA and other building codes, there are certain clearances that need to be kept from air intakes and buildings, lot / property lines, parked vehicles, and sprinkled buildings of noncombustible construction. A footprint of approximately 160 feet x 180 feet (28,800 sf), as shown on Figure E.3 is required for a hydrogen yard to fuel 50 buses (including required clearances). Physical enclosure of the actual yard is a much smaller footprint of 40 feet x 50 feet (2,000 sf). Note the 50-foot setback from the hydrogen storage tanks to the property lines. Whereas CNG compression yards are often found on the perimeter of sites, more care is needed to locate a hydrogen compression yard. To provide a full hydrogen fueling option, Figure E.3 has an assumed hydrogen compression / storage yard “module” to fuel 50 fuel cell electric buses (FCEB). The 50 FCEB “module” is an assumed representative equipment layout and multiple alternative equipment configurations are possible.

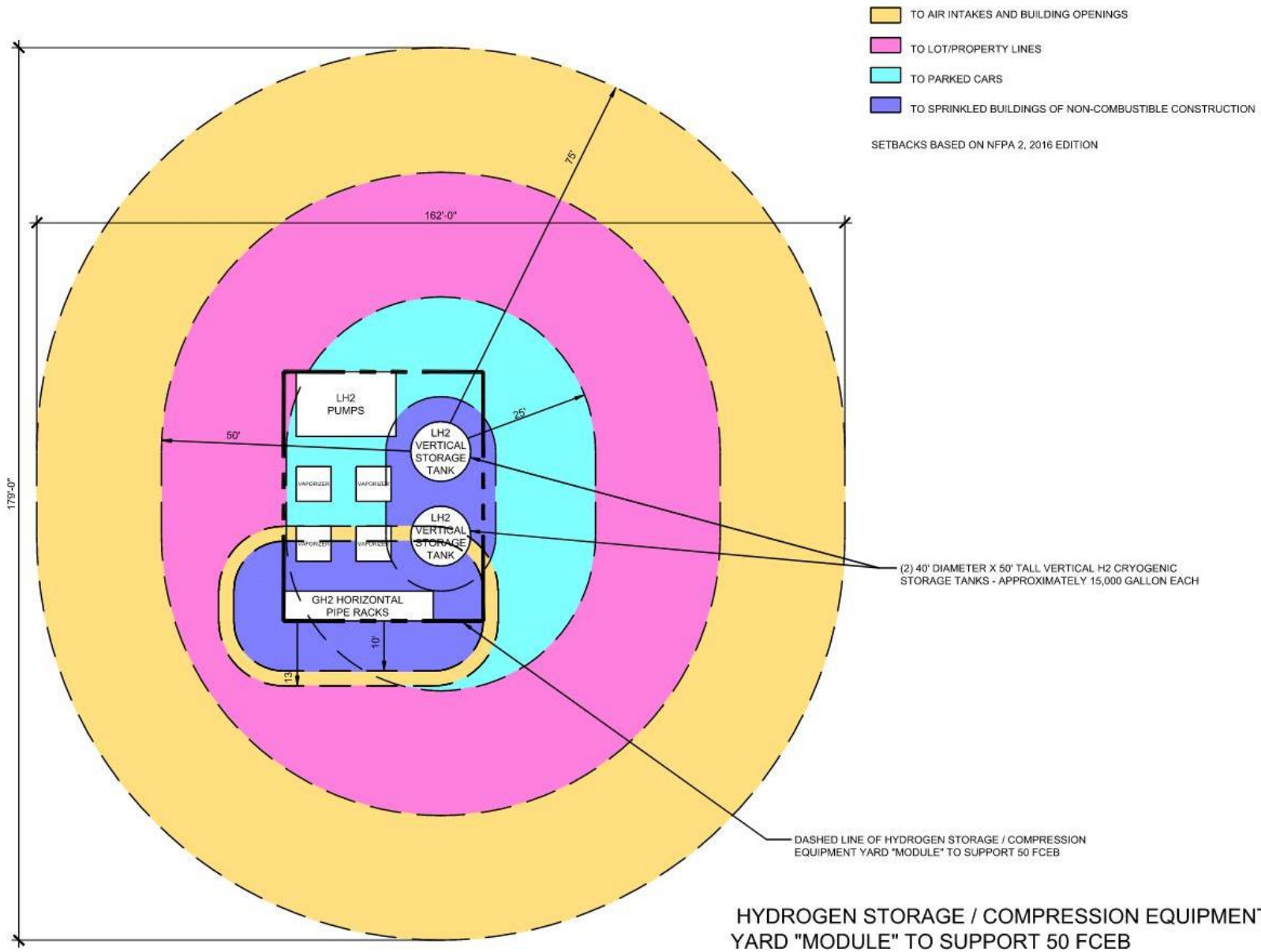



# SITE AND BUILDING REQUIREMENTS

---

## INTRODUCTION

The following pages describe the site and building requirements for the project during future detail design. The building components and discipline systems are described to document the anticipated preferred Yuba Sutter Transit building systems types to be used as a basis of design for the facility during future design development. The code, standards and permits requirements listed are the minimum anticipated elements needed to secure a future construction and occupancy permit after detail design has been completed.

## CODES, STANDARDS, AND PERMITS

- All design elements shall be based on the requirements of local, state, and National Codes and standards. Due to the unique functions associated with this type of facility, a detailed code review shall be performed at the beginning of detailed design to incorporate all codes and standards related to the facility.
- The code review shall include listing and discussion of fire prevention methods, occupancy separations, and area classifications. Particular attention must be given to the impacts of the use of fuel cells and other alternative fuels.
- A comprehensive list of all permits required from national, state, and local authorities, utility owners, and other private entities shall be prepared and included in the preliminary design submittal.
- The design shall meet all applicable regulatory requirements for the handling, storage and waste disposal of hazardous materials.
- The new Yuba-Sutter Transit Facility shall be accessible to persons with disabilities in accordance with ADA Accessibility Guidelines (ADAAG) and the authority having jurisdiction (AHJ) over final selected site to be used for detail design. Compliant at a minimum with:
  - California Building Code 2019 Edition or most recently adopted version
  - California Electrical Code 2019 Edition or most recently adopted version
  - California Energy Code 2019 Edition or most recently adopted version
  - International Fire Code 2018 Edition or most recently adopted version
- The design must meet all applicable State and local energy standards, policy & guidelines.

## CIVIL

The civil design should address the following issues. These issues are not meant to represent the full extent of civil involvement and are only intended to convey basic functional requirements in an effort to facilitate coordination during detailed design.

## SURVEY

- A survey of the site will be provided showing all pertinent existing boundaries, property lines, above and below ground utilities, easements, and topography. Underground utility location shall be verified by potholing where necessary.

- 

#### SOILS, EARTH RELOCATION, AND OTHER CONSIDERATIONS

- A geotechnical investigation shall be performed to gain detailed information regarding surface and subsurface soil conditions.
- Recommendations from the geotechnical investigation shall be utilized in site development design.

#### STREETS

- The proposed access street and any improvements required for existing streets should be designed to conform to applicable standards and codes and shall be approved by the responsible authority.
- Any off-site circulation and roadway improvements will be prepared under a separate design project. This project will be coordinated with the off-site project. IF APPLICABLE

#### PARKING LOTS

- Concrete should be provided for all driveways and agency vehicle parking areas.
- Concrete should be provided for all fueling positions, vehicle washing, vehicle details and dumpster areas.
- Driveways into the site must be sufficient to accommodate heavy loads and frequent traffic.
- Asphalt paving with concrete curbs is sufficient for exterior employee/visitor parking areas.
- Concrete wheel stops and/or curbs should be furnished in automobile parking lots only where required for physical protection of buildings, landscaping, fencing, and as needed for storm drainage. Use of curbs should be limited allowing as much storm water as possible to return to the ground.
- A concrete apron should be provided for access to all bays, fueling lanes, and vehicle washers. Concrete bypass lanes should also be provided around these facilities where practical.
- All slopes should be perpendicular to vehicle parking where practical.
- Vehicle parking areas shall include pavement markings, signs, sidewalks, and lighting as required for safe and efficient operations.
- Pavement markings shall be paint striping with no projections so that the surface can be easily swept and cleaned.
- Pavement markings shall be thermoplastic.
- Low profile fully adhered RPM's (Raised Pavement Marker) with reflective surfaces to be utilized on crosswalks, handicap spaces, and circulation routes.
- Landscaping in employee/visitor parking areas should be provided as recommended by the local jurisdictions.
- Parking spaces and passenger loading zones shall be provided to comply with Accessibility Standards and all codes and ordinances enforced by the final authority having jurisdiction.

#### SITE DRAINAGE

- All storm drains shall be routed to a central sampling point in a location to be determined by the final authority having jurisdiction.

- New pavement grades should be established with an attempt to maintain a minimal grade of 1.00% (asphalt) and an absolute minimum grade of .5% (concrete). Maximum pavement grades should be limited to 6%. If greater slopes are required, care must be taken to ensure that vehicles will not bottom-out due to abrupt grade changes.
- Adequate quantities and sizes of catch basins and drains should be provided to keep paved areas free of standing water during normal rainfall.
- Site drainage should include oil/water separation and retention/detention as required by state and local codes prior to discharge into storm sewer, sanitary sewer, or natural outlet location.
- Building foundation elevations should be integrated to the site drainage to avoid the need for stairways at personnel entrances and excessive grades at vehicle entrances.
- Drainage should always be directed away from buildings and facilities.
- Drainage design shall address wetlands protection and avoidance if wetlands are present.
- All outside vehicle maintenance areas to be canopy covered.

#### SITE UTILITIES

- Electrical, telephone, water, irrigation water, natural gas, sanitary sewer, and storm drainage/retention availability, capacity, and characteristics should be determined by the detailed design team.
- All utility services shall conform to local codes and requirements.
- All utility services should be underground.
- The specification should stipulate that the contractor is to pay for any tap-in fees.
- Single point electrical service will be provided to the facility by the local power utility.

#### LANDSCAPE

The landscape design should address the following issues. These issues are not meant to represent the full extent of the landscape architect's involvement and are only intended to convey basic fundamental requirements in an effort to facilitate coordination during detailed design.

#### VEGETATION

- Vegetation should consist of low maintenance, drought resistant types.
- Vegetation that is compatible and indigenous to the surrounding area is preferred.
- Vegetation, decorative fencing, and berms should be used to screen parking areas and maintenance areas from the public view as applicable.
- A small lawn area would be appropriate near the main or visitor's entry to the facility.
- Vegetation should be placed to avoid conflict with visibility needs for vehicle circulation, ingress, and egress.
- Consideration should be given to perimeter vegetation selection and placement to avoid its use as a screen for criminal or undesirable social activities.
- Landscaping should be provided in employee/visitor parking areas and for any street improvements in the right-of-way as recommended by the final authority having jurisdiction, including county input.
- Consideration will be given to the size of fully mature plantings with respect to site lighting and parking lot safety concerns.

#### IRRIGATION

- All new landscaped areas shall be provided with an automated drip irrigation system.
- Irrigation system shall conform to local water use standards and limitations.
- Underground piping circuit lengths shall be minimized and sized to reduce required water delivery time to appropriate durations.
- Irrigation shall be provided with an automatic controller, separate water meter, water backflow devices, control valves, zones, pipe irrigation system, and rain sensor with automatic shutoffs.

## STRUCTURAL

The structural design should address the following issues. These issues are not meant to represent the full extent of structural involvement and are only intended to convey basic fundamental requirements in an effort to facilitate coordination during detailed design.

### FOUNDATIONS

- Foundation design shall be based on the recommendation of the geotechnical investigation reports.
- Control joints in floor slab shall be provided at adequate spacing, to minimize cracking.

### FLOOR LOAD RATINGS

- Floor loads shall be determined by occupancy per accepted codes and standards.
- Where practical, floor loads should be consistent for all occupancies on a given floor.

### STRUCTURAL STEEL

- Structural members should be provided with corrosion protective coatings based on the functions of spaces in which they are exposed.
- Exposed joists and other structural members shall be provided with ample future loading for miscellaneous support loads.
- Use of open frame structural members will facilitate air movement and prevent accumulation of flammable gases.

### TRENCHES (DRAIN AND PIPING) AND SUMPS (DRAINED AND COLLECTION)

- Trenches and sumps should be coordinated with structures, architectural elements, mechanical and utilities, and fixed equipment.
- Trenches and sumps should be covered with steel plate or grating consistent with the floor loading and finishes specified for the space served.
- All trench and sump grates to be removable. Grates to be a manageable and readily removable size.
- Do not install equipment and fixtures in such a way as to limit the ability to remove grating for trench and sump cleaning and maintenance.
- Steel support beams and angles or nosing should be imbedded in the trench or sump mouth to support the trench covers and to prevent trench wall spalling.
- Trench and sump walls and floor finishes should be epoxy coated to prevent excursions of the piping fluids (see Plumbing) into or through the concrete.
- Trench bottoms shall slope to drainage or collection points as required.
- All piping trenches shall be drained to an oil / water separator.
- The method of pipe support attachment in the trench shall be detailed to provide adequate space for future piping modifications/replacement and keep the pipe off the trench bottom.

## ARCHITECTURAL

The architectural design should address the following issues. These issues are not meant to represent the full extent of the architect's involvement and are only intended to convey basic fundamental requirements in an effort to facilitate coordination during detailed design.

## GENERAL CONSIDERATIONS

- The overall architecture of the facility and its aesthetics should create the feeling of unity and proper relationship of all components.
- The facility design shall be ADA compliant.
- The facility should be oriented to take advantage of cross ventilation in the work bays, if practical.
- Natural light should be utilized wherever possible. Vertical orientation (windows) should be used instead of horizontal orientation (skylights) to avoid problems with leaking.
- This will be a "no smoking and vaping" facility.
- Avoid "air pockets" in vehicle bays where explosive gases could accumulate at the ceiling.
- Slope roof structure of maintenance bays to a high point to facilitate evacuation of flammable gasses.
- Expandability and flexibility are important factors to consider in planning the building.
- The building should provide employee amenities and convey sense of pride and professionalism.
- The design will provide the necessary separations between building occupancies as required by code.
- Design "open" structures for fuel and wash such that lighter than air gases are not trapped below the roof.

## DESIGN DIMENSIONS AND CLEARANCES

The design of the facility must allow for safe and efficient movement of personnel, equipment, agency vehicles, and delivery vehicles. In order to provide proper clearances, the following minimum unobstructed clearances will be maintained. Note that "unobstructed clearance" means structure, lighting, mechanical ductwork, and any other obstructions must be above the minimum vertical clearances indicated.

- Hallways, Doorways, Interior Grade Changes, and Restrooms: ADA standards.
- Ceiling Clearances (minimums):
  - Offices areas: 8'-6".
  - Parts Rooms: 12'-0".
  - Shops: 14'-0".
  - Repair Bays: 19'-0"
  - Vehicle Washer: 16'-0"
- Door Openings (width by height):
  - Parts Rooms: 10'x10' (interior) and 12'x14' (exterior at Loading Dock).
  - Shops: 10'x10' (for forklift access).
  - Repair Bays: 14'x14'
  - Vehicle Washer: 14'x14'
  - Any door to accommodate vehicle traffic: 14'x14'

- Circulation (width):
  - Pedestrian corridors: 6'-0".
  - Forklift aisles: 10'-0".
- Work Area:
  - Engine end of vehicle: 10'-0".
  - Opposite end of vehicle: 5'-0".
- Bay Width and Depth (width x depth):
  - Repair Bays: 20'x60' for 45 ft. buses (25' wide when adjacent to a wall).
  - Steam Clean Bay: 20'x70'.
- Parking Space Dimensions (width x length):
  - 45' Over the road Commuter Coaches: 14'x50'. Spaces shall be designed as such to allow for flexibility and accommodate all vehicle lengths, including the 35 ft. Transit Coaches.
  - Support/Employee/Visitor Vehicles: 10'x20'.
  - Handicap Parking Stall: per ADA standards. VERIFY PARKING SPACES WITH CURRENT FLEET AND PROJECTED FLEET
- Turning and Circulation Requirements (90° turn):
  - Medium vehicle (auto, light truck, van): 25'.
  - Transit Coaches: 70'.
  - Forklift: 12'.

#### MATERIALS

The facility design should utilize materials that not only are aesthetically pleasing but are also durable and cost effective. The materials should also be appropriate for the functional area in which they are used. Some of the areas in which careful selection of materials is very important due to the specialized functions are:

- Vehicle Washers.
- Steam Clean Bay.
- Lube/Compressor Room.

If a composite wall system is used, CMU or another hard surface should be used at least up to eight feet above finished floors. Mechanical fasteners that are exposed to the weather or a wet environment should be constructed from stainless steel.

#### FLOORS

- Floors in all repair bays and shops shall be flat with no slope.
- Floors in wash bays shall slope to the trench drains.

#### FLOOR LOAD RATINGS

- Floor loads shall be determined by occupancy per accepted codes and standards
- Where practical, floor loads shall be consistent for all occupancies on a given floor.

#### FINISHES

Room finishes are an important element in the design of this type facility. The wrong finish can not only be dangerous but can also be very costly to replace. The following are specialized finishes inherent with maintenance functions:

- Epoxy painted CMU walls in all repair bays and maintenance shops.
- Epoxy painted CMU walls or glazed block with epoxy grout in vehicle wash areas.
- Soil and grease resistant walls.
- Painted exposed ceiling structure (light reflective color).
- Soil, grease, and water resistant concrete floors with an integral non-metallic hardener, light reflective coloring, and sealer.

#### DOORS

- All door types and materials should be standardized throughout the facility except in spaces that have hostile, corrosive environments, such as wash areas and chemical storage.
- Exterior overhead garage doors should be insulated high lift aluminum frame type with full view glass panels.
- Door controls shall allow for only full up or down (not partially closed). Doors shall open completely.
- Door thresholds should be avoided in maintenance and shop areas unless necessary. If thresholds are required, they should be of industrial grade in maintenance and shop areas.
- Doors and doorways should meet applicable accessibility requirements.
- All shop doors entering onto corridors should have automatic fire closures.
- All overhead doors shall have a manual override and ability to be raised and lowered manually.
- Doorframes shall be all welded. Knockdown type frames are not acceptable.

#### BOLLARDS

- Protective bollards should be provided at all overhead doors and where protection of personnel, structures, and equipment are deemed necessary.
- Steel curb faces and corner edges should be provided at all raised concrete islands associated with protecting the building or equipment.

#### HOUSEKEEPING PADS

- Housekeeping pads and isolation pads should be provided for appropriate electrical, mechanical, and plumbing equipment. Other housekeeping pads may be functionally necessary for some shop equipment.
- Housekeeping pad and isolation pad design should be coordinated with the structural engineer to ensure pad strength and uniformity throughout the facility.
- Exposed housekeeping pad surfaces should drain away from the equipment supported on them.
- Housekeeping pad surface finishes should be consistent with room floor finishes.

## MECHANICAL

The mechanical design should address the following issues. These issues are not meant to represent the full extent of mechanical involvement, and are only intended to convey basic functional requirements in an effort to facilitate coordination during detailed design

### HEATING, VENTILATION AND AIR CONDITIONING

- All enclosed occupied building areas should be provided with heating and ventilation in accordance with code requirements.
- All office areas should be provided with air conditioning and heating to 72 degrees Fahrenheit, 50% relative humidity.
- Air conditioning in areas with communication equipment, computers, data, servers, AVL and security equipment should maintain a temperature of 68 degrees Fahrenheit with 50% ± 5% relative humidity year round. These spaces should have a separate HVAC system.
- Positive pressure must be maintained in all offices and break rooms adjacent to repair bays to preclude migration of fumes into these areas.
- Restroom areas should maintain negative pressure, drawing air from adjacent spaces for ventilation.
- Ventilation of repair bays should include a portion of supply air inlets near the floor and exhaust inlets near the ceiling.
- Maintenance areas should be ventilated and heated with particular attention to the effects of air movement on the perception of comfort.
- Provide for smoke and heat venting in repair areas. Make use of smoke curtain boards as required. Do not create air pockets at ceiling.
- Spot cooling in maintenance areas, per ASHRAE, should provide for a velocity of 200 fpm across the worker. Supply should be via personal cooling fans near a bay opening; exhaust via fans in a mechanical penthouse (monitor exhaust system).
- Repair and inspection areas shall be ventilated by at-floor exhaust and shall conform to the ventilation requirements of NFPA 513 and NFPA 30A. These systems will remove vapors which are heavier than air.
- Provide smoke, CO<sub>2</sub>, NO<sub>x</sub> detectors in vehicle areas to adjust ventilation rates in response to vehicle activity.
- Mechanical systems must be “zoned” so that adjustments can be made in response to varying demand and activity.
- HVAC building management control system shall be computer controlled and accessible by Maintenance personnel through the Agency’s internal computer network system.
- The HVAC system shall utilize a central plant modular VRF (variable refrigerant flow) system that includes both cooling and heating to each of the zones. Each spacing having the ability to be controlled to the desired temperature. Exhaust Ventilation
- Exhaust ventilation, where required, should be provided in accordance with all applicable codes.
- An overhead vehicle exhaust reel system should be provided for all vehicle maintenance bays. Reels should be located at the appropriate end of each stall. Economies should be reviewed for service of a large number of exhaust reels by a single, variable speed exhaust fan as compared to multiple exhaust fans (one per reel). Adapters should be provided to accommodate each different bus type in the fleet.
- Vehicle exhaust hose should be selected for continuous operation at the high temperatures resulting from diesel bus exhaust.
- Vehicle exhaust ductwork should be selected for corrosion resistance.
- Dust collection systems must be installed and maintained in compliance with all applicable codes.

### ENERGY CONSERVATION AND MANAGEMENT



- Mechanical and electrical design efforts should coordinate to evaluate the cost effectiveness of the following:
  - ~ Using high efficiency motors.
  - ~ Duty cycling of HVAC systems (rotating "off" periods).
  - ~ Demand load shedding controllers for non-essential HVAC motors.
  - ~ Reduced voltage or current limiting starting for large motors.
  - ~ Power factor correction for large motors.
  - ~ High efficiency cooling and heat recovery units.
  - ~ Use of automatic dampers and variable frequency motor controllers to allow a central fan to efficiently collect exhaust from only the exhaust hose reels in use, even though several reels are ganged together via common ductwork to the central fan.
  - ~ Soft start capability for larger motors (40 hp or greater).
- Increase sizing of long pipe and duct runs to achieve reduced horsepower and reduced electrical consumption.
- Provide a heat recovery system for compliance with energy codes and economy of operation.
- Passive solar solutions (orientation, natural lighting, cross ventilation) should be evaluated.
- A centralized Energy Management System (EMS) based on the following criteria, among others:
  - ~ Ability to conform to peak load criteria for energy cost savings.
  - ~ Automated equipment maintenance scheduling resulting in lower anticipated equipment life cycle costs.
  - ~ Benefits of monitoring equipment performance to be within acceptable limits.
  - ~ Utility usage patterns.
  - ~ Temperature setbacks corresponding to occupancy and utilization patterns.
  - ~ Uniform and limited control of temperature settings.
  - ~ Filter performance monitoring and replacement pattern data accumulation.
  - ~ Ability to monitor and record indoor and outdoor conditions affecting HVAC systems, as well as alarms, failures, and abnormal operating conditions.
  - ~ Ability to automatically control selected equipment such as chillers, air handlers, pumps, fans, boilers, heaters, valves, and automated dampers, as well as lighting in selected areas.
  - ~ Ability to perform energy accounting by displaying/recording electrical and natural gas flows.
- Passive energy consumption reduction strategies, such as increased insulation and isolation of temperature controlled and ambient spaces and increased equipment capacities to reduce duty cycles, should be utilized to the best advantage of the facility.

#### POLLUTION CONTROL

- Mechanical systems designs shall insure that airborne and waterborne contaminant emissions will meet all applicable codes and regulations.
- The percentage of air re-circulated into the occupied spaces of the facility should take ASHRAE recommendations into account to avoid "sick building syndrome" and other undesirable effects associated with stagnant air.

#### MECHANICAL/EQUIPMENT ROOMS

- The mechanical discipline should provide guidance to the architect concerning the size and location of mechanical and equipment rooms and utility chases.

- Mechanical room sizing should take heat exchanger tube and air filter removal, as well as other common maintenance activity clearance requirements, into account as well as space and clearance required by ASHRAE and building codes, and the recommendations of the design basis equipment manufacturer should also be taken into account.
- If computer controls are used in mechanical/equipment rooms, the temperature in the space must be maintained in conformance with the control manufacturer's requirements.

## ELECTRICAL

The electrical design should address the following issues. These issues are not meant to represent the full extent of electrical involvement and are only intended to convey basic functional requirements in an effort to facilitate coordination during detailed design.

### POWER

- The site electric service voltage shall be coordinated with the power utility early in the detailed design. The electrical engineer should provide the architect with direction concerning the form, space requirements, and site impacts of the transformer and service entrance.
- In most cases, motors larger than 1/2 HP should be supplied 480 VAC, 3-phase or 208 VAC, 3-phase if 480 VAC is not available.
- Dedicated circuits and conduit connections should be provided throughout the facility for computer terminals.
- A dedicated circuit, 120 VAC convenience receptacle should be provided at each telephone terminal backboard.
- Spare capacity (50%) should be provided at all panel boards and switchboards.
- Surge suppression equipment should be provided either at the panel boards from which isolated ground receptacle circuits originate or individually at the appropriate outlet.
- A 90-minute battery backup system should be provided for the following items:
  - Radio and dispatch system.
  - Fire alarm and other fire protection and security systems.
  - Exit lights.
  - Telephone PBX
  - Computer Server/Data/Technology Rooms
- Computers should be connected to battery powered UPS packages with surge protection.
- Rack mounted equipment within telecom rooms should be connected to battery powered UPS packages with surge protection.
- All electrical equipment should be suitable for the area classification of the area for which it is designed to be installed.
- All wall outlets and disconnects should be labeled with panel locations.
- Removable traffic bollards should protect the transformer and service entrance equipment.
- The main distribution system voltage should be 480/277 volts, 3 phase, and 4-wire grounded neutral with a 4-wire fault system that meets or exceeds the National Electrical Code requirements.

- Circuit breakers in the main switchboard should have ground fault protection set to trip before the main circuit breaker as well as solid state trip devices with adjustable long time and short time settings.
- Distribution of branch circuits and feeders should take the application of emergency power and zone electrical shutdown requirements into account.

#### BUILDING EMERGENCY GENERATOR

- A building emergency generator should be sized to accommodate the full facility of the facility power needs, excluding that of charging battery electric buses. The generator should be connected to the main distribution system in such a manner as to promote maximum flexibility for utilizing emergency power.
- The emergency generator location should be determined during facility layout finalization. It should be close to the electrical service equipment, will require an outlet for hot exhaust gasses, and will require ample intake and ventilation air.
- Due to the noise and heat from the engine, the generator should be isolated from facility occupants.
- The components to be connected to the emergency generator should be verified during the detailed design.
- An automatic transfer switch should transfer the load from utility power to the engine generator after the engine gets up to speed and the generator up to frequency.
- The emergency power system will be composed of both uninterruptible loads and interruptible loads. Uninterruptible loads are those that must remain operational due to a life safety issue or is of a critical nature or in the case of some computers, where unwanted data loss or damage may occur. Interruptible loads are those than can tolerate a momentary interruption of power while power is being transferred by the automatic transfer switch.
- Regulatory approval and permits to construct/operate the emergency generator shall be provided prior to final authority having jurisdiction. For acceptance and operation. **IF APPLICABLE**

#### GENERAL LIGHTING TYPES AND LIGHTING LEVELS

- All lighting levels shall be equal to those suggested by the Illuminating Engineers Society (IES) Handbook and authority having jurisdiction over final selected site.
- **Office Light Fixture:** 50 FC. Use color corrected LED lamps with energy efficient ballast and parabolic reflectors. Fixture mounted in acoustic ceiling tile grid. 3 lamp fixture capable of being switched for either 1 lamp on or all three lamps on.
- **Office Light Fixture Dimmable:** 50 FC to 2 FC. Dimmable can light with color corrected LED lamps capable of being dimmed with no flickering or discernable noise (hum) from fixture. Fixture recessed in ceiling.
- **Service Light Fixture - Shop:** 50 FC. color corrected LED lamps with energy efficient ballast and acrylic diffuser or lamp protective metal grid diffuser. Fixture mounted in acoustic ceiling tile grid or surface mounted to exposed structure. 3 lamp fixture capable of being switched for either 1 lamp on or all three lamps on.
- **Service Light Fixture – Utility spaces:** 20 FC. color corrected LED lamps with energy efficient ballast and acrylic diffuser or lamp protective metal grid diffuser. Fixture mounted in acoustic ceiling tile grid or surface mounted to exposed structure. 3 lamp fixture capable of being switched for either 1 lamp on or all three lamps on.

- **Service Light Fixture – Storage rooms:** 20 FC. Color corrected LED lamps. Fixture mounted in acoustic ceiling tile grid or surface mounted to exposed structure. Single light fixture.
- **Waterproof service light fixture** – 20 FC. LED lamps with energy efficient ballast and acrylic diffuser. Fixture surface mounted to exposed structure. 3 lamp fixture capable of being switched for either 1 lamp on or all three lamps on.
- **Wet location sealed light fixture** – 30 FC. color corrected LED lamps with energy efficient ballast and acrylic diffuser. Fixture recessed mounted in ceiling / soffit or surfaced mounted to exposed structure. 3 lamp fixture
- **Wet location sealed fixture w/ diffusers** – 30 FC. Non-ferrous light fixture body with LED lamps with energy efficient ballast and indirect reflector or acrylic diffuser. Fixture recessed mounted in ceiling. 3 lamp fixture.
- **Indirect light fixture over mirror** – 30 FC. color corrected LED lamps with energy efficient ballast and indirect reflector. Fixture recessed mounted in ceiling. 3 lamp fixture.
- **High Bay Fixture** – 70 FC. High output color corrected LED lamps with energy efficient ballast. Lamp protection by either clear lamp wrap or impact resistant diffuser. Fixture surface mounted or suspended from exposed structure.
- **Waterproof High Bay Sealed Fixture** – 70 FC. High output non-ferrous light fixture body with LED lamps with energy efficient ballast. Lamp protection by clear lens. Fixture surface mounted or suspended from exposed structure.
- **Explosion proof sealed fixture w/ diffusers** – 50 FC. color corrected LED lamps with energy efficient ballast and indirect reflector or acrylic diffuser. Fixture recessed mounted in ceiling. 3 lamp fixture.
- **Task Light – Shops** – 100 FC. Color corrected LED lamps with energy efficient ballast. Fixture surface mounted to wall / column on swivel mounts to allow light to be direct / adjusted by users. Individually switched fixture controlled by user independent from room / space lighting.
- **Task Light – Chassis Wash / Detail Clean** – 100 FC. High output color corrected LED lamps with energy efficient ballast. Sealed waterproof fixture surface mounted low on wall / column on swivel mounts to allow light to be direct / adjusted by users. All tasks light in Chassis Wash and Gantry Washer floor area, doubled used as Detail Clean, controlled by single switch and independent from room / space lighting.
- **Site lighting fixture – Agency Vehicle parking, circulation, and Agency Service areas.** 10 FC. LED lamps with energy efficient ballast. Pole mounted or surface mounted to building / structure walls. Sealed clear lens with adjustable light cutoff and “Dark Sky” compliant fixture.
- **Site lighting fixture – Yard Storage, Employee and other parking and circulation areas.** 5 FC. LED lamps with energy efficient ballast. Pole mounted or surface mounted to building / structure walls. Sealed clear lens with adjustable light cutoff and “Dark Sky” compliant fixture.
- **Site lighting fixture – BEB Charging.** 50 FC. LED lamps with energy efficient ballast. Pole mounted or surface mounted to canopy / structure over bus parking. Sealed clear lens with adjustable light cutoff and “Dark Sky” compliant fixture.
- Site lighting (exterior only) should be photocell controlled.
- Light poles in the agency vehicle parking area should be limited to the perimeter if possible.
- Site lighting shall comply with any local light pollution regulations.
- Employee parking and agency vehicle parking areas must meet the City / County standard lighting levels for security and the prevention of accidents.
- Office lighting levels shall be equal to those suggested by the Illuminating Engineers Society (IES) Handbook and the City and County’s standards.
- Each repair bay shall be individually switched.

- Lighting shall be suitable for the area classification in which it is designed to be installed. Areas such as the vehicle wash area and others will bear special consideration.
- Damp or wet location fixtures shall be labeled and used in appropriate locations.
- Interior lighting should be controlled locally but may be integrated to the Energy Management System in cases of single shift occupancies.
- Extra lighting must be provided in all areas (exterior and interior) with vehicle movement at night.
- Areas where television, CCTV, or personnel interface monitors (computer screens) are used should have non-glare lighting treatments.
- All lighting levels shall comply with the City and County's established standards.

#### FIRE ALARM AND DETECTION

- Fire alarm and fire/smoke detection devices shall be provided to monitor all areas in the facility.
- Fire alarm pull boxes shall be provided at exits.
- Activation of any detector or pull-box shall result in an audible/visual alarm throughout the facility, interact with the mechanical systems, interact with the fire protection/suppression system (ref. plumbing), and transmit an alarm signal via telephone line to a centrally located monitor and the local fire department monitoring station.
- The fire alarm control panel shall provide visual and audible annunciation for each initiating zone.
- The fire alarm control panel shall be located in a conspicuous place.
- All control panels shall be located in appropriate locations.

#### TELEPHONE/DATA COMMUNICATIONS AND RADIO

- A system of empty conduits, outlet boxes, and terminal backboard shall be provided in each building of the facility and between buildings.
- Conduits should include pulling ropes.
- Computer network wiring schemes shall be coordinated with the Agency.
- Most telephones should have long distance restrictions on outgoing lines.
- Equipment rooms with computerized equipment must have an appropriate HVAC system that monitors the proper temperature.
- Conduit for communication cabling shall be provided to all CCTV cameras.
- One-inch conduit shall be provided to every workstation to provide for up to 2 voice and 2 data lines per workstation. This shall be verified during detailed design.
- A minimum of 150% of actual requirements shall be provided for conduit between buildings to accommodate future growth and spares.
- Only gel fill cabling shall be used for feed cabling between buildings and from closet to closet.
- Current cabling technology shall be used.

#### PAGING/PUBLIC ADDRESS SYSTEM

- A paging/public address system shall provide service to all offices, shops, repair bays, and outdoor work areas around the maintenance building and vehicle parking area.
- System speakers shall be of a type suitable for areas of high ambient noise.

- The control equipment shall be complete with provisions to permit interfacing with the telephone system to allow origination of paging from telephone instruments by dialing an assigned number.
- The volume level of individual speakers shall be adjustable without sacrificing system performance.

## PLUMBING

The plumbing design should address the following issues. These issues are not meant to represent the full extent of plumbing involvement and are only intended to convey basic functional requirements in an effort to facilitate coordination during detailed design.

### PLUMBING AND PIPING SYSTEMS

- The following piping systems may be incorporated within buildings, as applicable:
  - Domestic Hot and Cold Water (HW and CW)
  - Fire Protection Water
  - Sanitary Recyclable and Vent
  - Industrial Recyclable Water
  - Roof Drainage
  - Storm Drainage
  - Compressed Air (CA)
  - Automatic Transmission Fluid (ATF)
  - Engine Coolant (EC)
  - Engine Oil (EO)
  - Fuel Gas/Low Pressure Natural Gas
  - Vehicle Wash Water
  - Diesel Fuel (DF)
  - Diesel Exhaust Fluid (DEF)
  - Windshield Washing Solution (WS)
- Piping which contains soil-contaminating fluids shall not be direct buried in earth.
- Piping which is required to communicate with services across floors and vehicle traffic areas should be routed in trenches as described in the structural section of Chapter 4.
- All piping should be readily accessible and available for visual inspection.
- Fuel gas/low pressure natural gas house line to be tested for inspection.
- The plumbing discipline should provide the structural discipline with trench width and turning area requirements with attention given to wrench clearances between fittings and pipes where appropriate or necessary for safe maintenance practices.
- The preferred methods for supporting pipes shall be detailed along with their arrangement and routing.

- Piping supports shall allow for the possible modest addition of future services and piping.
- Each piping system shall have shut-off valves overhead except for fire protection systems, gravity forced systems.
- All piping sizes should be based on maximum expected flows.
- A set of pipe specifications shall be developed such that at least one specification section exists for each fluid service type with design pressures and temperatures not to exceed the expected operating pressure and temperature extremes of the system in question. The pipe specification should detail the material, design conditions, suitable valves and fittings in the appropriate size ranges, minimum pipe wall thickness, and required insulation, if any.
- Pipe insulation is required for domestic hot water.
- Industrial recyclable water must go to an oil/water separator.
- Where required by code, piping shall have secondary containment with leak detection.

#### PLUMBING FIXTURES

- All plumbing fixtures, where applicable, should be of a water saving, low flow design and be consistent with the client's standards.
- Water closets should be wall-hung, flush valve type.
- Urinals in maintenance areas shall be wall-mounted, durable, low maintenance type.
- Hand washing stations shall be provided in shop areas. Consider use of touchless faucet activation device. Two types of hand washing stations shall be provided with one being a trough type, stainless steel sink with gooseneck faucets, and long handles and the second being of semi-circular stainless steel design with either foot activated bar for water flow activation or infrared sensor operation.
- Showers for men and women shall be individual type.
- Eyewash and safety showers shall be located in hazardous areas and must be connected to the sanitary sewer.
- Standard stainless steel paper towel dispensers and hand dryers shall be provided in restroom facilities.
- All drainage shall have adequate slope towards the drainage points.
- Trap primers shall be used as required by local codes and shall be installed on lines with a reasonable expected frequency of operation.
- Exterior hose bibs shall be key-type and of the "freezeless" variety.
- Water hammer arrestors should be properly applied to the system.
- Use of instant-on electric water heaters should be considered for restroom facilities without showers.
- Flush valve handles on handicapped closets to be located the on wide side of the stall.
- Use of large "paddle" handles on fixtures (water closets, urinals, and hand washing faucets) should be considered.

#### DRAINS

- All floor/area drain piping should be sized based on the maximum expected flow loading with a generous allowance for fouling due to gravity flow velocities.
- Drain grates and frames shall be cast iron.
- There shall be no drains in lubricant containment areas.

- Drains from maintenance areas shall pass through adequately sized oil/water separators.
- Some areas such as lift pits and vehicle wash require special drains, traps, and sumps. These components should be identified and coordinated early in the detailed design.
- Drains should be located away from maintenance activities, where possible, so as not to impede movement of toolboxes and portable equipment.
- Vehicle wash water must connect to an oil/water separator, unless the treatment plant design and drain configuration address this issue.
- All trench drains must connect to an oil/water separator, unless the treatment plant design and drain configuration address this issue.
- Outflow from oil interceptor shall connect to the sanitary sewer.

#### COMPRESSED AIR SYSTEM

- The compressed air system shall have a “loop” distribution system.
- Compressed air should be provided to all maintenance work areas and to other designated locations.
- Compressed air drops should consist of the following components: ball cut-off valve, filter, regulator with gauge, lubricator, 1/4 inch quick disconnect, and a 6 inch drip leg with automatic drains.
- Compressed air should be suitable in quality, quantity, and pressure for tool operation, including pneumatic engine starters, and tire pressurization. Simultaneous use of tools may occur in particular areas.
- Instrument and/or breathable air should be provided for equipment as applicable.
- The compressed air system shall have appropriately sized air receivers located in the compressor room. The receivers shall have automatic drains.
- All branch lines for the compressed air header shall exit from the top of the header, except drip legs to condensate drain traps which shall exit from the bottom.
- All lines, including main header, shall be sloped to drain to drip legs with condensate drain traps.
- Designer shall evaluate cost, reliability, and benefits of regenerative, refrigerated, and combination refrigerated and deliquescent air dryers to obtain compressed air with a suitable pressure dew point to prevent condensation under winter ambient design conditions.
- A pressure switch shall be mounted in the main air header and shall activate an audible and visual alarm when the switch detects pressure at or below 90 PSI.
- Quick connect fittings for different services, such as lubricated air, paint/blast air, and breathing air shall be color-coded and be non-interchangeable.
- A separator and filter shall be mounted between the air receiver and the air dryer.
- The air dryer, as well as the upstream separator and filter, shall be designed to handle the maximum surge flow from the receiver or the compressor rated flow, whichever is greater.
- All receivers shall be equipped with automatic condensate drain traps that shall discharge to the industrial recyclable system.
- All valves in the compressed air system should be of the ball-type.

#### LIQUID BULK STORAGE/DISTRIBUTION

- The most economical method of purchasing and storing liquid consumables is in bulk. Recyclable liquids can also be handled in bulk. Storage capacities that are to be provided at the facility are listed under the appropriate space in the Functional Requirements section.



- Fuel tanks and fuel delivery piping shall be equipped with leak detection and alarm and automatic gauging devices. Alarm location shall be identified during detailed design. Leak detection and alarm equipment must be computer controlled with compatible connection to the Agency's network.
- Each tank will be separately vented at a safe distance from grade and from site facilities and equipment.
- All tanks containing environmentally hazardous materials should be of the double wall type, thus providing secondary containment in the event of inner wall failure. A leak detector should be located in the annulus between the inner and outer shells.
- The facility shall be provided with a central lubricant system. This system should provide a variety of lubricants to the appropriate location (refer to the Functional Requirements section) by utilizing the following components:
  - Air piston lubricant pumps; wall-mounted whenever possible.
  - Compressed air to operate lubricant system
  - Lubricant and fluid hose reel banks mounted overhead or on specially fabricated racks.
  - Bulk lubricant and fluid storage tanks and associated piping.
  - Lubricant and fuel dispensers.
- The floor below the lubrication pumps and storage tanks should be a grating covered containment sump with a manually operated drainage valve normally closed except during wash down. Note that a containment sump is not required under double wall tanks.
- Air piston pumps should be used to transfer the lubricants listed in the Functional Requirements section.
- Noise from the pumps and lubrication system must be isolated from all mechanic work areas and adjacent spaces.
- All storage tanks should be equipped with relief valves or devices to protect from over or under pressure conditions.

#### OPERATING PRESSURES

- Operating pressures of liquid consumables distributed throughout the facility via the central lubricant system shall be verified during detailed design to be compatible with the pressures generated by the pumps.

#### FUEL MANAGEMENT SYSTEM

- A fuel management system should be provided at the fueling area to monitor use of all fuels and lubricants dispensed.
- Consideration should be given to installation of a fully automated system, using radio frequency or similar data transfer techniques.
- Final installation details may vary based on the approved fuel management system manufacturer.
- The diesel fuel directed to the emergency generator should be monitored by the fuel management system and drawn from the main fuel island tanks if possible.
- Fuel management system performance during fire alarm situations should be addressed.
- Provisions for premature vehicle pull-out should be included in the design. Examples include breakaway hoses and traffic signals tied to the fuel dispenser solenoid.

#### LEAK DETECTION/INVENTORY MONITORING SYSTEM

- Underground fuel storage tanks, pump/piping manholes, dispenser boxes and fuel supply piping will be equipped with automatic leak detection monitoring and alarm, automatic gauging/inventory monitoring and overflow monitoring and alarm.
- Bulk oil lubrication tanks will be provided with leak detection monitoring and alarm

- Leak detection/inventory monitoring system monitoring and alarm panel location will be identified during detailed design.

## FIRE PROTECTION SYSTEM

- Fire protection systems such as automatic fire sprinklers, standpipes, fire hose cabinets, and fire extinguishers shall be designed, as required, for maximum safety in accordance with the requirements of all applicable codes and the local Fire Department for each hazard occupancy.
- Fire hydrants and pump connection locations shall be coordinated with the local Fire Marshall or other appropriate local authority for the type and class of firefighting equipment serving the site.
- The building fire alarm shall shut down process fluid flow to the building.
- The fire alarm system shall have the option for testing individual alarm function.
- Provide map of entire fire suppression system, installed at the Control Panel location. Also, provide evacuation route maps, behind glass, in appropriate locations.
- An FM 200 dry chemical system shall be used in computer equipment rooms.

## STRUCTURAL/ARCHITECTURAL

- Eliminate pockets (where possible) where gas could collect.
- Utilize open roof framing to facilitate air movement and to eliminate pockets.
- Utilize pitched roofs where possible.
- Provide bulkheads and/or separation walls and doors between vehicle and non-vehicle areas.
- Consider utilizing fast-acting, rubber, coiling doors with breakaway feature to provide for pressure relief at all exterior overhead door locations.
- Door motors should be Division 1 rated and on the emergency stand-by power system.
- Roof awnings (or overhangs) should be avoided or ventilated to prevent accumulation of gases.
- Fall arrest systems should be provided above vehicle repair bays to allow mechanics to safely work on the top of the vehicle. The fall arrest systems should cover the length of the vehicle. At least two bays should be provided initially.

## SECURITY

During detail design a separate security workshop should be conducted to verify and finalize security requirements outlined in the Design Criteria.

## FENCING

- The entire yard area must be secured (with fence, walls, and/or buildings).
- Fenced areas will need control gates at access/egress points. Gates will be accessed by key card and will be connected to the Agency's current standard security card access system via the Agency's network.

## LIGHTING

- Sufficient security site lighting should be provided at building exteriors, at perimeter fencing locations, and in employee and vehicle parking and driveway areas.

- Security lighting should not adversely impact surrounding property.

#### CCTV

- The CCTV system should be routed to the appropriate location within the facility to be determined by Yuba-Sutter Transit.
- Cameras, at a minimum, should be provided at the front of all bay doors, employee parking lot, vault pull, shipping and receiving areas, the reception desk, vehicle parking area, and at any money handling location.
- Cameras in employee parking shall be stationary with panning capability.
- A non-switched electrical source shall be provided to the CCTV system.
- Specific CCTV camera locations shall be identified early in the detailed design process and shall be coordinated with security.

#### CARD ACCESS SYSTEM

- The facility should be equipped with a card key access system. The system must be connected to the Agency's internal network system.
- Card access locks, at a minimum, should be provided at all storage rooms, manager's offices, outside doors, the lobby vestibule inner door, and parking access gates.
- A new Access Control System (ACS) shall be provided. The ACS shall consist of card readers, door contact alarms, passive infrared sensors, door contact switches, exit pushbuttons, duress pushbuttons, electromagnetic door locks and proximity type electronic key cards. Card access locks, at a minimum, should be provided at all storage rooms, manager's offices, outside doors, the lobby vestibule inner door, and parking access gates.
- Cabling from ACS equipment shall be routed to the nearest telecommunications room. Cabling from exterior ACS equipment or routed between buildings shall pass through and terminate at TVSS equipment prior to being terminated at ACS headend equipment. ACS cabling shall be terminated at wall mounted intelligent field panels. These panels shall be connected together via the fiber optic backbone and connect into an alarm monitoring workstation / headend system server.
- ACS system equipment shall be powered from building emergency power.
- The ACS shall interface with the new CCTV system to provide video recording of ACS alarm points.
- Emergency call boxes will be located within the employee parking lots. The boxes will interface with telephone, access control and CCTV system. An alarm condition will ring the phone at the dispatch center, send an alarm to the access control system and cause the CCTV camera near the call box to view that area.

#### OTHER SECURITY CONSIDERATIONS

- An electronic security system shall be provided for the entire facility. The system specifications must be coordinated with the Agency during detailed design.
- All security systems must be carefully coordinated with the Agency during detailed design.
- Vegetation should be thorny where possible and should not provide hiding places.
- Panic buttons with a two-way speaker system should be provided in the employee parking area.
- Coordinate with local law enforcement during detailed design.
- From a safety and security standpoint, it would be ideal if access to the site were restricted.

### SIGNAGE AND GRAPHICS

Proper signage and graphics throughout the facility are important. Because of the complex industrial workflow, safety regulations, mixing of vehicle and pedestrian traffic, employee performance codes, and the requirements of the Americans with Disabilities Act, high quality graphics that promote a positive organizational image are important. Properly designed graphics will not only add to the aesthetics of the facility, they will also assist employees in performing their assigned tasks more efficiently and safely. Specific signage and graphics requirements including safety, directional, informational, traffic signs, and pavement markings should be developed during detailed design to be consistent with the Agency's standards.

- All exposed pipes, conduits, and major lines in the maintenance areas should be color coded for easy identification. Color-coding should be accomplished with full painting if possible, or color-banding at a minimum, and meet the Agency's standards.
- All reel banks shall be labeled.
- Design of a monument sign shall be by the Agency.

### WASTE HANDLING

- Appropriate space for storage and handling of waste must be provided. Inadequate storage space can result in an unsightly mess that is difficult to control. There are four types of materials for which storage must be provided.
  - Trash: This consists of the facility's trash and waste products which cannot be recycled. Provide a canopy covered area for one 6-yard dumpster.
  - Scrap Metal: Ferrous and non-ferrous scrap metals. A contract scrap dealer may provide containers for collection and removal, but adequate space and vehicle circulation must be considered when locating scrap areas. Provide a canopy covered area for one 6-yard dumpster.
  - Recyclable: Bins may be provided for recycling steel, brass, copper, glass, aluminum, paper, and other selected materials (including tires and oil filters). Provisions for these should be included in the facility design. Provide one 6-yard dumpster.
  - Organics: Collection of organic materials such as... Which can be collected and removed from the facility. Provide a canopy covered area for one 6-yard dumpster.
  - Hazardous Materials: Many items are now considered hazardous materials and must be dealt with in special ways. Some of these items are tires, batteries, paint, solvents, light bulbs and tubes, and contaminated oil filters. Containers for hazardous materials may be provided for storage and collection, but adequate space and vehicle circulation must be considered when locating these containers. Storage of hazardous materials must provide secondary containment.
- The central waste collection facility should be canopy covered to prevent water infiltration.

### FACILITY MAINTENANCE

- Storage space for janitorial supplies and equipment must be provided in each area.
  - Space must be provided for charging batteries on floor scrubbers, carts, and manlifts.
- A floor sink with hot and cold water is required in each janitorial room.



# APPENDIX A SIGN IN SHEET

PROJECT NAME: Yuba-Sutter Next Gen BEB

## SIGN-IN SHEET



DATE: 1/28/2020

NAME	ORGANIZATION	JOB TITLE	EDUCATION	PHONE NUMBER	E-MAIL ADDRESS
Jewels Carter	WSP	FUNCT DGN	Houston	281-589-5878	Jewels.CARTER@wsp.com
Rafael Ruiz	WSP	FUNCT DGN	Houston	(281)589-5961	rafael.ruiz@wsp.com
Alva Carrasco	WSP	PM	Sacramento	916-621-9950	Alva.carrasco@wsp.com
Keith Martin	Yuba-Sutter Transit	Transit Manager	Marysville	530-634-6880	Keith@yubasuttertransit.com
Renick Haise	STORER Transit Systems	General Manager	Marysville	530-844-3906	rhaise@storerbus.com
Bill Harris	STORER Transit Systems	Asst Ops Manager	Marysville	530 844 3910	bharris@storerbus.com
Bill Hammer	STORER	Director	CA	805 779 136	BHammer@StorerBus.com
Adam Hansen	Yuba-Sutter Transit	Planning Program Manager	Marysville	634-6880	adam.hansen@yubasuttertransit.com
Simone Reed	Yuba-Sutter Transit	Finance Program Manager	Marysville	634-6880	simone@yubasuttertransit.com

PROJECT NAME: Yuba-Sutter Next Gen BEB

**SIGN-IN SHEET**



DATE: 1/29/2020

NAME	ORGANIZATION	JOB TITLE	LOCATION	PHONE NUMBER	E-MAIL ADDRESS
Rafael Ruiz	WSP	Proj. Assoc.	Houston	281-589-5961	rafael.ruiz@wsp.com
Bruce Cannon	Storer	Maint. Manager	Modesto	209-769-5417	bcannon@storerbus.com
Bill Hummer	STORER	Maint. Director	Corp.	805-717-9436	bhummer@storerbus.com
Renick House	Storer	General Manager	Marysville	530-844-3906	rhouse@storerbus.com
Jewels Carter	WSP	FUNCTIONAL	Houston	281-589-5878	Jewels.Carter@wsp.com
Kevin Martin	Yuba-Sutter	Transit Mgr			
Adam Hassen	Yuba-Sutter Transit	Planning Admin Manager	Marysville	530-634-6280	adam@yubasuttertransit.com
Bill Harris	Storer	Asst Ops Manager	Marysville	530-844-3910	bharris@storerbus.com
STEVE FERNANDES	Storer	Vice President	Modesto	209-758-7924	STEVE@STORERBUS.COM

DATA A ?



PROJECT NAME: Yuba-Sutter Next Gen BEB

**SIGN-IN SHEET**



DATE: 1/30/2020

IT / Safety = Security / Wrap-Up

NAME	ORGANIZATION	JOB TITLE	LOCATION	PHONE NUMBER	E-MAIL ADDRESS
Rafael Ruiz	WSP	Proj. Assoc.	Houston	(281) 589-5961	rafael.ruiz@wsp.com
Alan Hansen	Yuba-Sutter	Planning Program		530-634-6280	
Keith Martin	Yuba-Sutter				
Amy White	Yuba-Sutter	Program Analyst		530-624-6080	amy@yubasuttertransit.com
Kenick House	Storer Transit	General Manager	Marysville	(530) 944-3906	rhouse@storerbus.com
Bill Hummer	-L	Maint. Dir.	Corp	805 717 9436	bhummer@storerbus.com
Bruce Cannon	Storer	Maint. Director	Corp	209-769-5417	bcannon@storerbus.com
STEVE FERNANDES	Storer	Vice President	Marysville	209-758-7224	Steve@Storerbus.com



## APPENDIX B PROGRAMMING QUESTIONNAIRES

---

### PROGRAMMING QUESTIONNAIRE

Your input is critical to the success of the project. The first step in the new Transit Operations and Maintenance Facility design process is to gain a thorough understanding of the functional requirements and operational characteristics of the facilities. Detailed discussions will be conducted with key stakeholders during Workshop #1 scheduled for January 28 through January 31, 2020. In preparation for those discussions, please fill out this questionnaire by close of business Thursday, January 23, 2020. Please forward completed questionnaires to Alva Carrasco at [Alva.Carrasco@wsp.com](mailto:Alva.Carrasco@wsp.com).

This questionnaire is to be completed by everyone that will participate in the Workshop #1 (Programming interviews) Please type or print clearly. Feel free to attach additional pages if necessary.

Your Name: Adam Hansen

Your Position / Title: Planning Program Manager

Your Department / Agency: Yuba-Sutter Transit Administration

Your Phone Number (530) 634-6880 Your E-Mail Address: adam@yubasuttertransit.com

1. Describe the primary function & activities of your department. What are your department's responsibilities?

General organizational and administrative oversight including all service planning, monitoring and reporting; procurement and monitoring of the private transit operations and maintenance contract; transit facilities planning, procurement and maintenance; fleet and major equipment planning and procurement; short and long-range budgeting; marketing and community relations; Board of Directors and member jurisdiction relations; technology procurement and administration; state and federal legislation and regulation monitoring and compliance; lost & found; counter sales and information; etc.

2. What factors are primarily responsible for the growth of your department?  
 Changes in ridership; system growth/changes; additional administrative burden due to new legislation, mandated reporting and audit requirements; increased customer service expectations/needs; increased need/use and complexity of technology; increased need/use and complexity of marketing/outreach; increased demands for new/additional transit services; increased need for regular and systematic service and operational oversight; increased human resource mandates, training and reporting.
3. Please provide a current organization chart for your department. Ideally, the chart would include names and/or quantities of people in each box.

[Yuba-Sutter Transit Chart Attached]

### ATTACHMENT 1

## YUBA-SUTTER TRANSIT ORGANIZATIONAL CHART



4. Please provide current and projected staffing by job title/position. [YUBA-SUTTER TRANSIT ADMIN.]

Job Title / Position	Number of People Per Position			
	2019 (current)	2024 (5 years)	2029 (10 years)	2039 (20 years)
<i>Example: Supervisor</i>	1	1	1	2
Transit Manager	1	1	1	1
Assistant Transit Manager	0	0	0	1
Planning Program Manager	1	1	1	1
Finance Program Manager	1	1	1	1
Program Analyst	1	3	3	4
Administrative Assistant	1	1	2	2
Office/Counter Assistant	0	0	2	2
Marketing & Outreach Specialist	0	1	1	2
IT Specialist	0	0	1	2
Program Manager (Undefined)	0	1	1	1

5. Please provide a list of existing revenue and non-revenue vehicles that may be operated from or maintained at the new facility. (Verify attached existing vehicle list as received in RFP)

[Existing Vehicle List Attached]

**YUBA-SUTTER TRANSIT  
VEHICLE INVENTORY  
EFFECTIVE JANUARY 1, 2020**

**REVENUE VEHICLES**

<u>Bus #</u>	<u>Year</u>	<u>Make</u>	<u>Model</u>	<u>Engine Type</u>	Total Seating	Estimated Replacement	Length (ft)
					<u>Capacity</u>	<u>Date</u>	
1681	2014	Chevy/Glaval	Titan II 4500	6.6 L/Diesel	16/2	2022	25
1682	2014	Chevy/Glaval	Titan II 4500	6.6 L/Diesel	16/2	2022	25
1683	2014	Chevy/Glaval	Titan II 4500	6.6 L/Diesel	16/2	2022	25
1684	2014	Chevy/Glaval	Titan II 4500	6.6 L/Diesel	16/2	2022	25
1685	2014	Chevy/Glaval	Titan II 4500	6.6 L/Diesel	16/2	2022	25
1686	2014	Chevy/Glaval	Titan II 4500	6.6 L/Diesel	16/2	2022	25
1690	2019	Ford/Glaval	Universal	6.0L/V-8 Gasoline	16/2	2026	24
1691	2019	Ford/Glaval	Universal	6.0L/V-8 Gasoline	16/2	2026	24
1692	2019	Ford/Glaval	Universal	6.0L/V-8 Gasoline	16/2	2026	24
1693	2019	Ford/Glaval	Universal	6.0L/V-8 Gasoline	16/2	2026	24
1694	2019	Ford/Glaval	Universal	6.0L/V-8 Gasoline	16/2	2026	24
1695	2019	Ford/Glaval	Universal	6.0L/V-8 Gasoline	16/2	2026	24
1696	2019	Ford/Glaval	Universal	6.0L/V-8 Gasoline	16/2	2026	24
1697	2019	Ford/Glaval	Universal	6.0L/V-8 Gasoline	16/2	2026	24
1698	2019	Ford/Glaval	Universal	6.0L/V-8 Gasoline	16/2	2026	24
1699	2019	Ford/Glaval	Universal	6.0L/V-8 Gasoline	16/2	2026	24
3150	2019	Gillig	Low Floor G27B	Diesel	31/2	2031	35
3151	2019	Gillig	Low Floor G27B	Diesel	31/2	2031	35
3152	2019	Gillig	Low Floor G27B	Diesel	31/2	2031	35
3153	2019	Gillig	Low Floor G27B	Diesel	31/2	2031	35
3154	2019	Gillig	Low Floor G27B	Diesel	31/2	2031	35
3155	2019	Gillig	Low Floor G27B	Diesel	31/2	2031	35
3156	2019	Gillig	Low Floor G27B	Diesel	31/2	2031	35
3157	2019	Gillig	Low Floor G27B	Diesel	31/2	2031	35
3158	2019	Gillig	Low Floor G27B	Diesel	31/2	2031	35
3159	2019	Gillig	Low Floor G27B	Diesel	31/2	2031	35
3160	2019	Gillig	Low Floor G27B	Diesel	31/2	2031	35

**YUBA-SUTTER TRANSIT  
VEHICLE INVENTORY  
EFFECTIVE JANUARY 1, 2020**

**REVENUE VEHICLES**

<u>Bus #</u>	<u>Year</u>	<u>Make</u>	<u>Model</u>	<u>Engine Type</u>	<u>Capacity</u>	<u>Date</u>	<u>Length (ft)</u>
3230	2013	Gillig	35DD	8.9L/Diesel	32/2	2026	35
3231	2013	Gillig	35DD	8.9L/Diesel	32/2	2026	35
3232	2013	Gillig	35DD	8.9L/Diesel	32/2	2026	35
3233	2013	Gillig	35DD	8.9L/Diesel	32/2	2026	35
3234	2013	Gillig	35DD	8.9L/Diesel	32/2	2026	35
3235	2013	Gillig	35DD	8.9L/Diesel	32/2	2026	35
3236	2014	Gillig	35DD	8.9L/Diesel	32/2	2026	35
3237	2014	Gillig	35DD	8.9L/Diesel	32/2	2026	35
3238	2014	Gillig	35DD	8.9L/Diesel	32/2	2026	35
3239	2014	Gillig	35DD	8.9L/Diesel	32/2	2026	35
3240	2014	Gillig	35DD	8.9L/Diesel	32/2	2026	35
5701	2010	MCI	D4500	11.0 L/Diesel	57/2	2025	45
5702	2010	MCI	D4500	11.0 L/Diesel	57/2	2025	45
5703	2010	MCI	D4500	11.0 L/Diesel	57/2	2025	45
5704	2012	MCI	D4500	11.9 L/Diesel	57/2	2028	45
5705	2012	MCI	D4500	11.9 L/Diesel	57/2	2028	45
5706	2012	MCI	D4500	11.9 L/Diesel	57/2	2028	45
5707	2018	MCI	D4500	11.9 L/Diesel	57/2	2034	45
5708	2018	MCI	D4500	11.9 L/Diesel	57/2	2034	45
5709	2018	MCI	D4500	11.9 L/Diesel	57/2	2034	45
5710	2018	MCI	D4500	11.9 L/Diesel	57/2	2034	45
5711	2018	MCI	D4500	11.9 L/Diesel	57/2	2034	45
5712	2018	MCI	D4500	11.9 L/Diesel	57/2	2034	45
5713	2018	MCI	D4500	11.9 L/Diesel	57/2	2034	45

**YUBA-SUTTER TRANSIT  
VEHICLE INVENTORY  
EFFECTIVE JANUARY 1, 2020**

**REVENUE VEHICLES**

<u>Bus #</u>	<u>Year</u>	<u>Make</u>	<u>Model</u>	<u>Engine Type</u>	<u>Capacity</u>	<u>Date</u>	<u>Length (ft)</u>
--------------	-------------	-------------	--------------	--------------------	-----------------	-------------	--------------------

**NON-REVENUE VEHICLES**

005	2003	Ford Truck	F350	6.0 L/Diesel	3		n/a
-----	------	------------	------	--------------	---	--	-----

**SUPERVISOR (TRANSDEV) VEHICLES**

010	2007	Ford	Escape	Gas/Hybrid	5		n/a
011	2009	Ford	Escape	Gas/Hybrid	5		n/a
012	2006	Ford	Explorer	Gas	5		n/a
013	2012	Chevy	Cruze	Gas	5		n/a
014	2012	Chevy	Cruze	Gas	5		n/a

\*First number is seated capacity, second number is the wheelchair capacity.

All vehicles **except** for the Supervisor (Transdev) vehicles, are titled to Yuba-Sutter Transit Authority

All vehicles are stored on-site at the Yuba-Sutter Transit facility located at 2100 B Street, Marysville, CA

P:\vehicles\vehicle list

Red: Data still needed in this category

Updated: 12/17/2019 By: APW



6. Please provide the projected vehicle replacement and expansion by year for the next 20 years that may be operated from or maintained at the new facility. (Can be submitted as separate attachment) **[Fleet Replacement/Expansion Lists are Attached]**

**EXHIBIT C**

**Yuba-Sutter Transit Authority Capital Improvement Plan (CIP)**

**Fleet & Facility Replacement/Expansion Schedule for the Metropolitan Transportation Plan (MTP 2040)**

**Adopted FY 2020 - FY 2024 Program of Projects**

Updated January 22, 2020

Current Model / Vehicle # / Service Type	Y-E #	Project Completion Fiscal Year																			
		2021	2022	2023	2024	2025	2026	2027	2028	2029	2030	2031	2032	2033	2034	2035	2036	2037	2038	2039	2040
<b>2014 Gillig Buses (3200's -- Fixed Route)</b>	<b>11</b>						13												13		
2019 cost estimate of \$500,000 each (\$1,000)							\$6,500												\$6,500		
MTP or MTP # (if any)							10370												NA		
<b>2012 MCI Buses (5704 - 5706 -- Commuter)</b>	<b>3</b>							5													
2019 cost estimate of \$600,000 each (\$1,000)								\$3,000													
MTP or MTP # (if any)								10360													
<b>2014 Glaval (1651 - 1686 -- Paratransit/Rural)</b>	<b>6</b>		7							10							10				
2019 cost estimate of \$95,000 each (\$1,000)			\$665							\$950							\$950				
MTP or MTP # (if any)			10400							10423							10428				
<b>2018 MCI Buses (5707 - 5713 -- Commuter)</b>	<b>7</b>																				
2019 cost estimate of \$600,000 each (\$1,000)																					
MTP or MTP # (if any)																					
<b>2019 Gillig Buses (3100 Series -- Fixed Route)</b>	<b>11</b>																				
2019 cost estimate of \$500,000 each (\$1,000)																					
MTP or MTP # (if any)																					
<b>2019 Glaval (1690 - 1699 -- Paratransit/Rural)</b>	<b>10</b>																				10
2019 cost estimate of \$95,000 each (\$1,000)																					\$955
MTP or MTP # (if any)																					NA
<b>2010 MCI Buses (5701 - 5703 -- Commuter)</b>	<b>3</b>																				5
2019 cost estimate of \$600,000 each (\$1,000)																					\$3,125
MTP or MTP # (if any)																					NA
	<b>2020</b>	<b>2021</b>	<b>2022</b>	<b>2023</b>	<b>2024</b>	<b>2025</b>	<b>2026</b>	<b>2027</b>	<b>2028</b>	<b>2029</b>	<b>2030</b>	<b>2031</b>	<b>2032</b>	<b>2033</b>	<b>2034</b>	<b>2035</b>	<b>2036</b>	<b>2037</b>	<b>2038</b>	<b>2039</b>	<b>2040</b>
Fixed Route (35')	22		22			22	24	24		24			28	26			28		28		26
Commuter (4.5')	13		13			15	15	17		17			21	21			21		21		21
Paratransit (25')	16		17			17	17	17		20			20	20			20		20		20
Running Fleet Total	51		52			54	56	58		61			69	69			69		69		69

**Facility Expansion/Replacement Projects**

2020 Budget Estimate (\$1,000)  
MTP # (if any)

Replace  
Facility  
\$25,000  
10424

(Common:TP-MTP/MTP Replacement Schedule.xls)

[Five Year Totals -- Buses & Facilities]

\$3,665

\$11,405

\$40,055

\$11,530

7. Typically, the spaces at a Transit Operations and Maintenance Facility fall under 3 major categories: Office Space /Driver & Mechanic Spaces / Support Spaces, Shop, and Storage.
- a. Please provide a listing of the Office Space / Driver & Mechanic Spaces / Support Spaces that you feel should be provided for your Department at the new facility (i.e. Supervisor, Break Room, Clerk, Locker Room, etc.)?

**ADMINISTRATION:**

Public Reception (Counter Sales, Photo ID Processing, Information & Referral, Waiting Area, Restrooms, etc.)

Administrative Support Office Space

Finance Office

Planning Office

Undefined Program Manager Office

Transit Manager & Assistant Transit Manager Offices

Executive Conference/Meeting Room (10 Person Capacity)

Administrative Work Room (Copier, Office Supplies, Layout, etc.)

Administrative Break Room/Kitchen, Restrooms & Quiet Room

Secure Administrative Storage Space (Lost & Found, Fare Media, Passenger Informational Materials, Bus Stop Supplies, Small Office Equipment, Etc.)

Large Long-Term Record Storage Space

IT Room (Server, System Control Room w/Joint Controlled Access to Contract Operations)

Office Expansion Space(s) (Future Employees, Contract/Consulting Office Space)



**OPERATIONS:**

Contract Manager Office  
Operations Manager Office  
Administration Office (Up to 3 desks)  
Dispatch/Control Center (Up to 4 Dispatchers/CSRs)  
Training Room  
Small Conference/Meeting Room (10 Person Capacity)  
Large Operations Break Room/Kitchen/Vending Machines  
Driver Recreation Room  
Operations Restrooms/Locker Rooms/Showers  
Operations Quiet Room (Rest between shifts)  
Operations Privacy/Nursing/Sick Room  
Operations Storage (Uniforms, Records, Supplies, Etc.)  
Secure Coin Room  
Road Supervisor Office (4 person)  
HR/Office Manager Office  
Driver Assignment Window  
Contract Reception Area/Lobby (Job Applicants, Vendors, Etc.)  
Office Expansion Space (Future Employees, Temporary Corporate Office Space, Etc.)  
Janitor Closet (Wash Sink, Janitorial Supply Storage, etc.)  
Water Fountain (Bottle Fill Station)  
Large Long-Term Record Storage Space  
Outdoor Break Area (Smoking & Non-Smoking)

**SHOP/PARTS/MECHANICS**

Parts Delivery/Reception Area  
Parts Clerk Office Space  
Parts Receiving/Processing Area  
Shop Manager Office  
Mechanic Desk Area  
Mechanic Break Room/Kitchen  
Shop Restroom/Showers/Locker Room  
Secure Tool Area  
Secure Parts Storage Area  
Hand Wash Area (Water Fountain & Bottle Fill Station)  
Janitor Closet (Wash Sink, Janitorial Supply Storage, etc.)  
Long-Term Record Storage Space

- b. Please provide a listing of the Shop type spaces that you feel should be provided for your Department at the new facility (i.e. Running Repair, Body Repair, Component Rebuild, etc.)?
- Running Repair/Inspection Bays
  - Vehicle Lifts (Portable vs. In-Ground, etc.)
  - Large Equipment Storage Areas
  - Tire Storage Areas
  - Battery Storage Areas (BEB Requirements?)
  - Air Compressor Room
  - Fluid Dispensing Area (Supply and Waste Tanks)
  - DEF Filter Burner (Special Power Supply)

Emergency Generator

Welding Area, Work Benches, Small Component Rebuild

Wash Bay (Portable vs. Drive-Through?)

Water Filter/Reclaim System

Chassis Wash / High Pressure Cleaner

c. Please list the types of items that need to be stored for your department at the new facility.

See above

8. What are the five most important items that must be addressed in the design of the new facility?

1) ZEB Integration

2) Accommodate Future Fleet & Staffing Levels (Workspace, Fleet Parking, Employee Parking & Visitor Parking)

3) Site & Facility Security (Public Access & Accommodation)

4) Emergency Operations (ZEB Support, Office Functions, etc.)

5) Sustainability (Design/Durability, Facility Operating & Maintenance Costs, Power Requirements, Etc.)

9. Based on your experience and observations, please suggest any changes which might improve the operational efficiency in your department?

Better Bus Parking Layout/Placement (Under Observation to Operations)

Separate Controlled/Secure Employee Parking w/Access to Building

Ease of Maintenance: Lights that can be replaced easily by maintenance staff, bus parking areas and driveways that do not crack and degrade, long life roof, etc,

Functional workspaces, individual office spaces, larger storage space

Minimal xeriscape landscaping (no grass)

Avoid pigeon perches

10. Based on your experience with your operation and/or that at other facilities, what specific features would you like to **AVOID** at the new facilities?

Must be able to adequately secure the parking, offices and shop areas whether open or closed

Better accommodate the public visiting the facility (security, restrooms, parking, etc.)

Must be accessible to the public (located near a key route / bus stop with safe path to door)

High maintenance landscaping or non-reliable systems or structures that require continual maintenance.

11. Based on your experience with your operation and/or that at other facilities, what specific features would you like to see **incorporated** into the design of the new facilities?

Solar panel covered parking areas for buses and employees

Better employee facilities available on site

Technology in conference room to allow for collaboration, teleconferencing and meetings.

Security cameras on parking lots/employee work areas

Employee and visitor parking separated from bus parking/circulation

*THANK YOU FOR YOUR RESPONSE*

## PROGRAMMING QUESTIONNAIRE

Your input is critical to the success of the project. The first step in the new Transit Operations and Maintenance Facility design process is to gain a thorough understanding of the functional requirements and operational characteristics of the facilities. Detailed discussions will be conducted with key stakeholders during Workshop #1 scheduled for January 28 through January 31, 2020. In preparation for those discussions, please fill out this questionnaire by close of business Thursday, January 23, 2020. Please forward completed questionnaires to Alva Carrasco at [Alva.Carrasco@wsp.com](mailto:Alva.Carrasco@wsp.com).

This questionnaire is to be completed by everyone that will participate in the Workshop #1 (Programming interviews) Please type or print clearly. Feel free to attach additional pages if necessary.

Your Name: Renick House

Your Position / Title: General Manager

Your Department / Agency: STORER Transit Systems Yuba Sutter

Your Phone Number: (530) 844-3906 Your E-Mail Address: rhouse@storerbus.com

1. Describe the primary function & activities of your department. What are your department's responsibilities?

Overall daily operation of transit, commuter, and dial a ride services for the Yuba Sutter Transit Authority. Operate, maintain and coordinate fleet. Data collection, storage, and reporting for all use of the system we operate. Initial and reoccurring employee training. Daily inspections of drivers and routes for operational safety and improvement.

2. What factors are primarily responsible for the growth of your department?

Changes in contracted service hours due to population increases, service area growth, ridership increases, extended human services funding availability or employment growth in the Yuba Sutter area. Fleet growth or changes in fleet composition due to the introduction of ZEB and related charging systems. Increased customer service demands.

3. Please provide a current organization chart for your department. Ideally, the chart would include names and/or quantities of people in each box. [Storer Chart Attached]

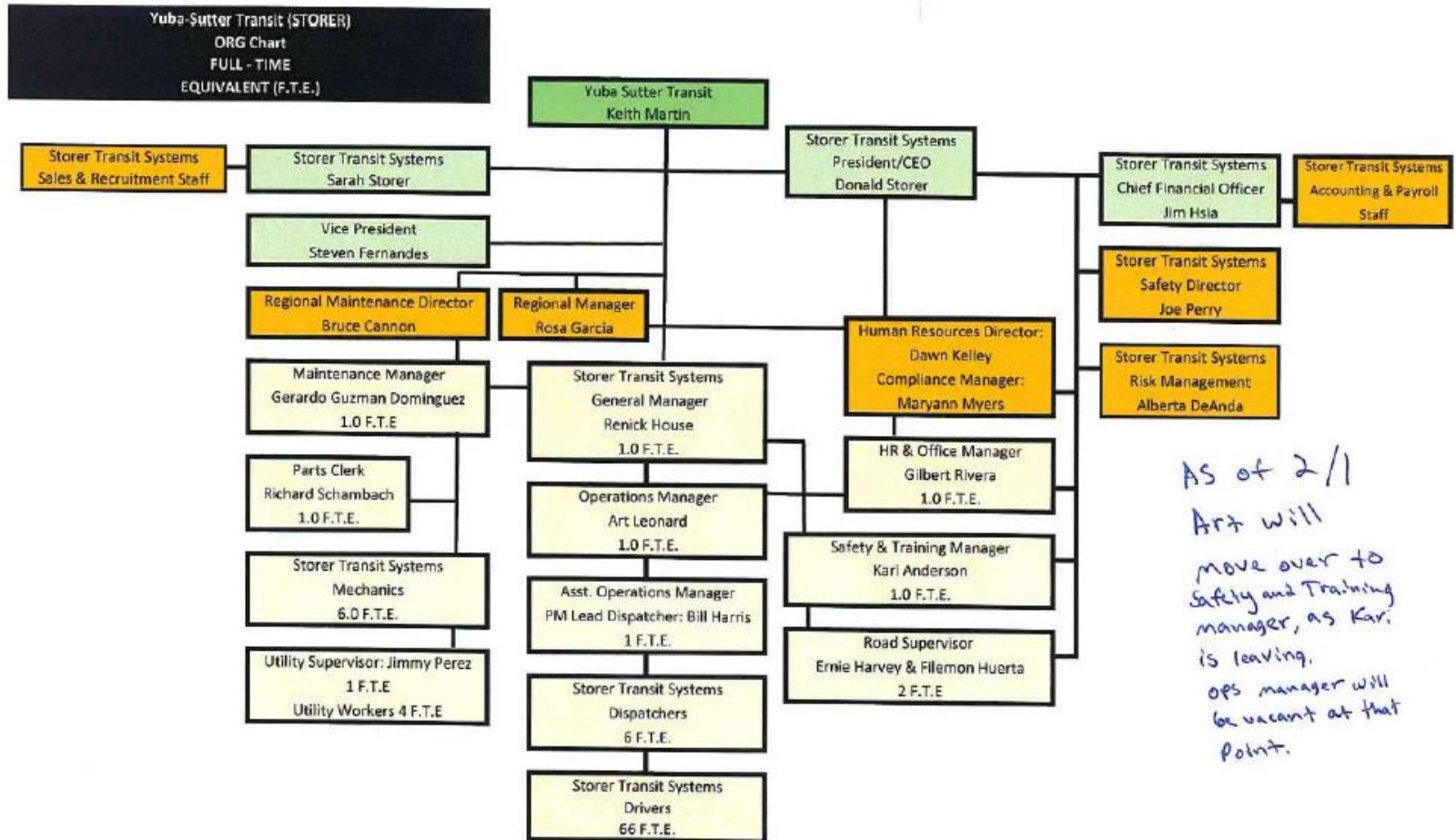

4. Please provide current and projected staffing by job title/position. **[STORER TRANSIT SYSTEMS]**

Job Title / Position	Number of People Per Position			
	2019 <i>(current)</i>	2024 <i>(5 years)</i>	2029 <i>(10 years)</i>	2039 <i>(20 years)</i>
<i>Example: Supervisor</i>	1	1	1	2
General Manager	1	1	1	1
Operations Manager	1	1	1	1
Safety Manager	1	1	1	1
Office Manager	1	1	1	1
Assistant Operations Manager	1	1	1	1
Safety Officer	1	1	1	1
Road Supervisor	2	2	3	3
Dispatcher	5	5	6	6
Driver	66	66	72	79
Customer Service Representative	1	4	4	4
Maintenance Manager	1	1	1	1
Parts Clerk	1	1	1	1
Mechanic	6	6	8	10
Electrician	0	0	1	2
Utility Supervisor	1	1	1	1
Utility	6	6	8	10



5. Please provide a list of existing revenue and non-revenue vehicles that may be operated from or maintained at the new facility. (Verify attached existing vehicle list as received in RFP)  
[\[See Yuba-Sutter Transit List in Yuba-Sutter Questionnaire\]](#)
6. Please provide the projected vehicle replacement and expansion by year for the next 20 years that may be operated from or maintained at the new facility. (Can be submitted as separate attachment)  
[\[See Yuba-Sutter Transit Fleet Replacement/Expansion Lists in Yuba-Sutter Questionnaire\]](#)
7. Typically, the spaces at a Transit Operations and Maintenance Facility fall under 3 major categories: Office Space /Driver & Mechanic Spaces / Support Spaces, Shop, and Storage.
  - a. Please provide a listing of the Office Space / Driver & Mechanic Spaces / Support Spaces that you feel should be provided for your Department at the new facility (i.e. Supervisor, Break Room, Clerk, Locker Room, etc.)?
  - b. Please provide a listing of the Shop type spaces that you feel should be provided for your Department at the new facility (i.e. Running Repair, Body Repair, Component Rebuild, etc.)?
  - c. Please list the types of items that need to be stored for your department at the new facility.
8. What are the five most important items that must be addressed in the design of the new facility?
  - 1) Bus parking pull through spaces and added capacity
  - 2) Pull through maintenance shop
  - 3) Appropriate office spaces for growth
  - 4) Power service and battery charging station
  - 5) Spacing between Maintenance, Operations and Authority offices.
9. Based on your experience and observations, please suggest any changes which might improve the operational efficiency in your department?

10. Based on your experience with your operation and/or that at other facilities, what specific features would you like to AVOID at the new facilities?

Congested fueling, wash bay and shop space.

11. Based on your experience with your operation and/or that at other facilities, what specific features would you like to see incorporated into the design of the new facilities?

Build with the charging stations and bus flow in mind.

*THANK YOU FOR YOUR RESPONSE*



## APPENDIX C CONSIDERED OPTIONS AND SITE TEST FITS

---

### INTRODUCTION

A new site will be selected for a new Yuba-Sutter Transit Operations and Maintenance Facility. As part of the site selection process, a set of 10 candidate sites have been identified and evaluated for their ability to cost-effectively accommodate the new Yuba-Sutter Facility.

A Site Selection Matrix was developed to identify ten viable sites for potential test fits based on the criteria of the Preliminary Space Needs Program. The site size required for the new Yuba-Sutter Transit site is approximately 9 usable acres per the Space Needs Program.

The sites identified are as follows:

Site 1 - 1356 N Beale Rd

- No test fit on this site.

Site 2 - 5962 Avondale Ave

- No test fit on site.

Site 3 - 6035 Avondale Ave

- Test fit on this site with three options. In addition to the test fit, a 3D rendering of Option 1c is provided to show the conceptual layout of the site. Enlarged plans and elevations are also provided for the buildings and charging options for the electrification of the vehicles.

Site 3a - 6062 Avondale Ave

- No test fit on site.

Site 4 - Chestnut Rd & Erle Ave

- No test fit on site.

Site 7 - Goldfields Parkway & Beale Rd

- Test fit on this site.

Site 9 - 1687 Hammonton Smartsville Rd

- No test fit on site.

Site 11 - 1055 N Beale Rd

- Test fit on this site.

Site 12 - 1441 E Onstott Rd

- Test fit on this site showing two options, one going north to south and one going east to west.

Site 14 - Butte House Rd & Tharp Rd

- No test fit on this site.



DRAWING NUMBER	DRAWING TITLE	 WSP WESTERN SOUTHERN PROJECTS SUITE 201, 12545 7TH A TELL CITY, IN 46784 TEL: (317) 998-0900 FAX: (317) 998-0100	 Yuba-Sutter Transit	PROJECT NO.	19215A
				DESIGNED BY	HR
	Site 3 3D VIEW			DATE	06/03/2020
S1				SCALE	NTS

BIM 360://HOU-193215A - YUBA SUTTER NEXT GEN BEB OMF 2019 - R19/Yuba-Sutter Site 3.rvt 8/4/2020 2:45:14 PM

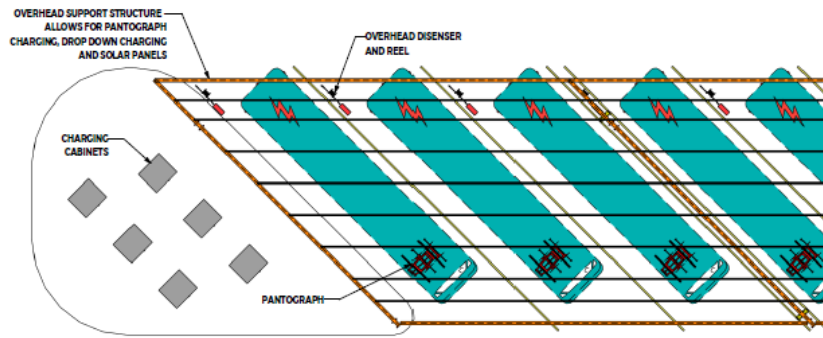

③ Enlarged Charging Plan  
1/8" = 1'-0"

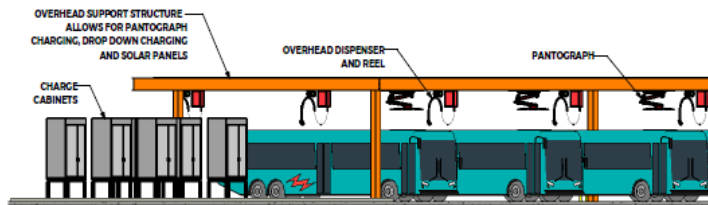

③ Charge Support Structure Section View  
1/8" = 1'-0"

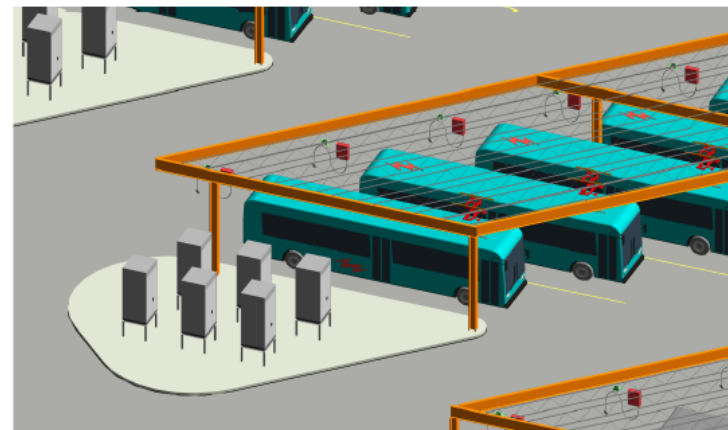

① 3D View of Overhead Structure and Charging Components

Page C.4

DRAWING NUMBER	PROJECT NO.	18235A
	DRAWN BY	RR
DRAWING TITLE	DATE	08/20/20
	SCALE	1/8" = 1'-0"
DRAWING TITLE	Yuba-Sutter Transit Resilient Next Generation Transit Facility Plan	
		
DRAWING TITLE		
	WSP USA, INC. 10501 PARK ROW HOUSTON, TEXAS 77064 TEL: 281.989.9900 FAX: 281.989.9704	
DRAWING TITLE	Site 3 BEB Charging Options	
DRAWING NUMBER	S2	

BIM 360://HOU-193215A - YUBA SUTTER NEXT GEN BEB OMF 2019 - R19/Yuba-Sutter Site 3.rvt 8/20/20 2:45:14 PM

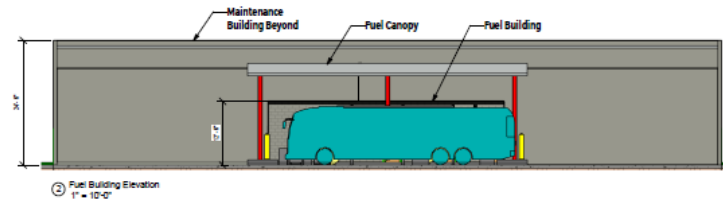
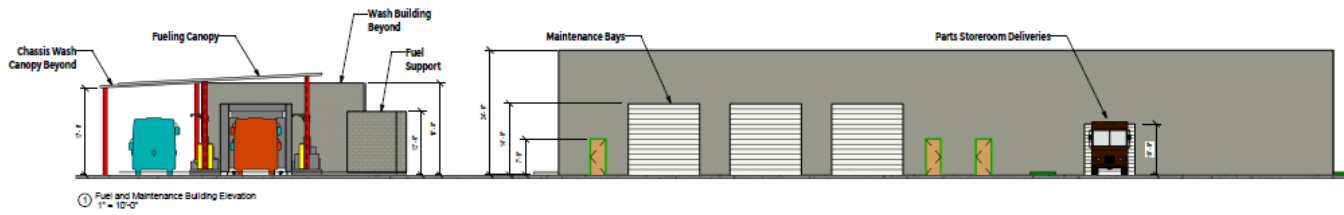

PROJECT NO.	193215A
DRAWN BY	RR
DATE	10/04/20
SCALE	1" = 10'-0"
PROJECT TITLE Yuba-Sutter Transit Resilient Next Generation Transit Facility Plan	
	
	
WSP HAS AN ISO 9001:2015 CERTIFICATION TEL: (916) 299-0900 FAX: (916) 299-0194	
DRAWING NUMBER	EL1
DRAWING TITLE	Site 3 Building Elevations
8/17/2020 9:30:51 AM	

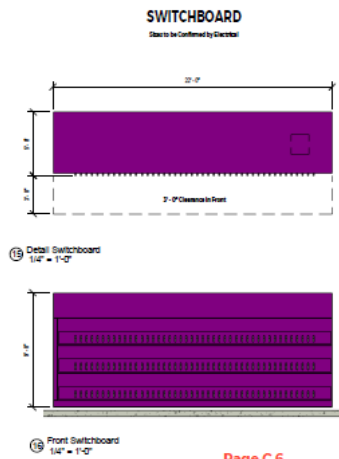
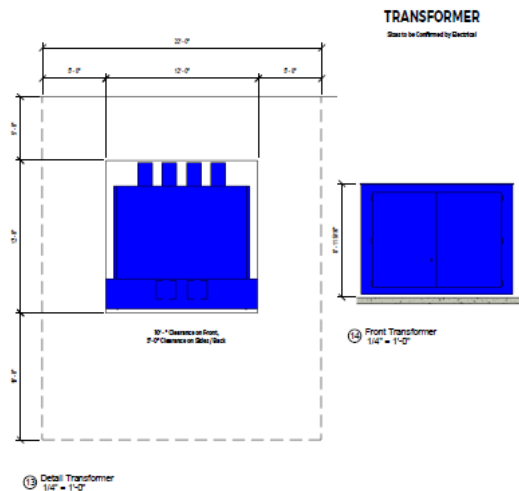
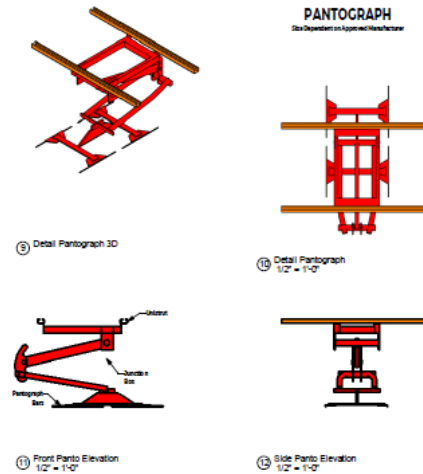
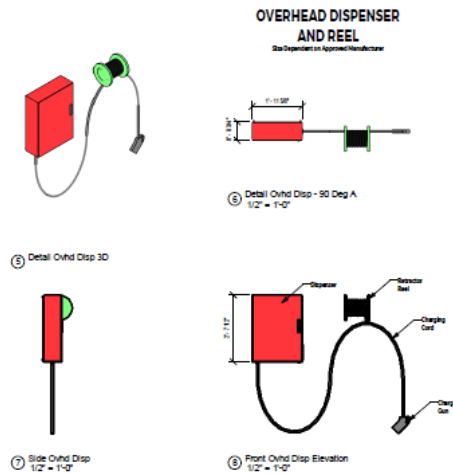
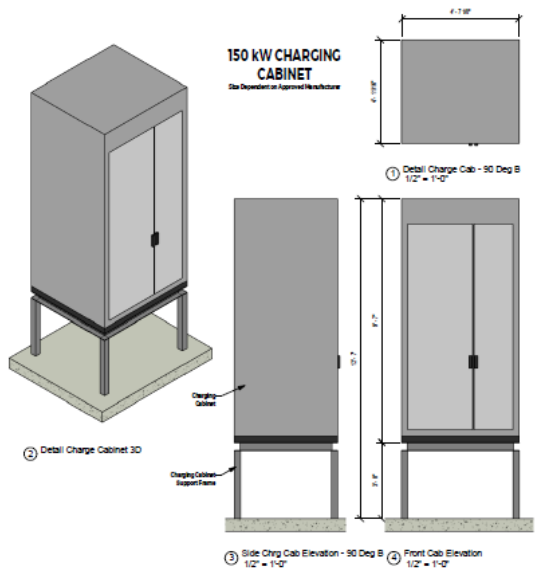

DRAWING NUMBER	DRAWING TITLE	PROJECT TITLE		
		Yuba-Sutter Transit Resilient Next Generation Transit Facility Plan		
BD	Basis of Design	PROJECT NO.	193215A	
		DATE	06/19/2019	NTS
		DRAWN BY	Author	
		SCALE		

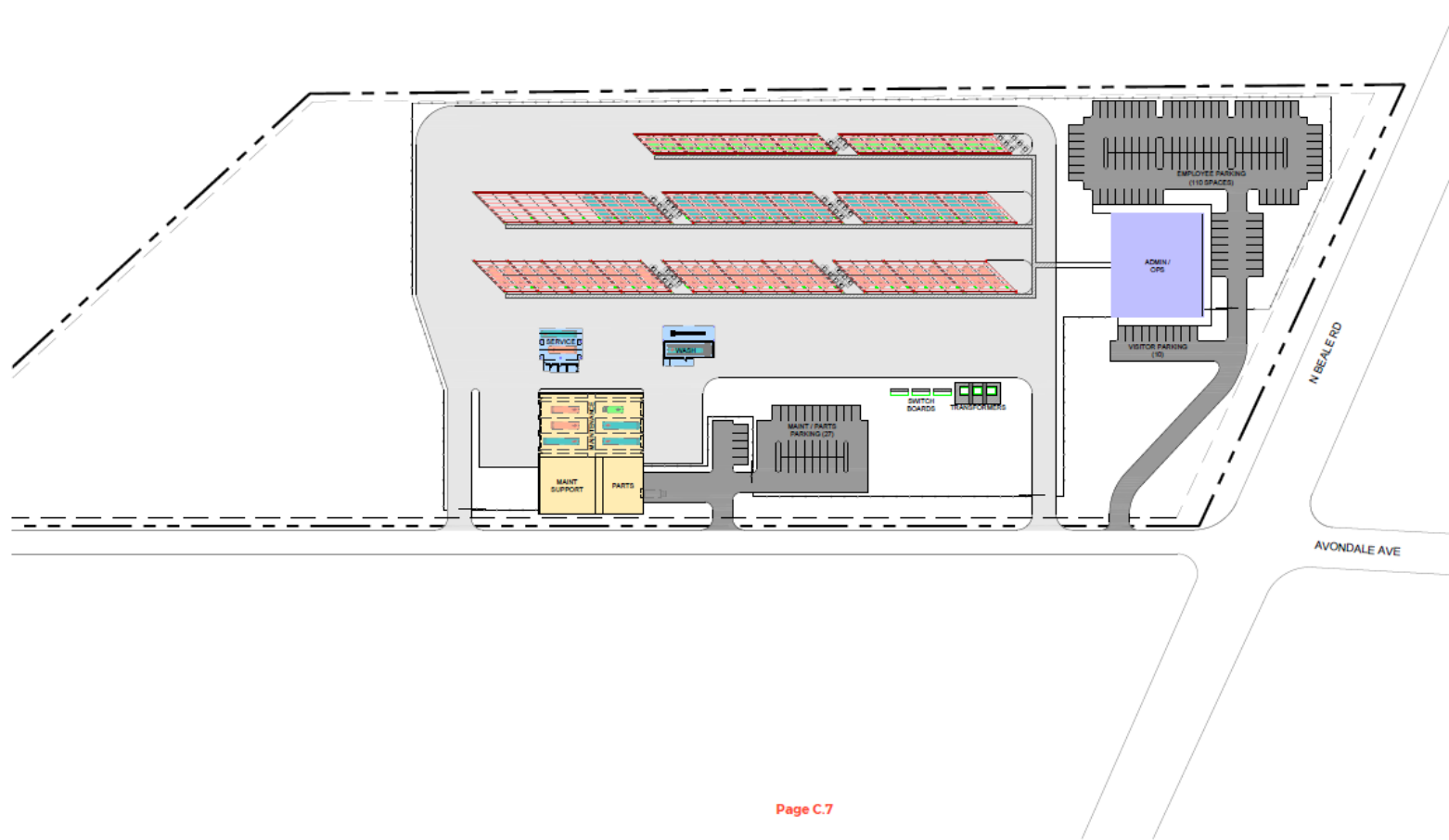

Page C.7

PROJECT NO.	18275A
DRAWN BY	BR
DATE	6/16/2020
SCALE	200x 1" = 60'-0"
	11.5.17 1" = 120'-0"
PROJECT TITLE	YUBA-SUTTER TRANSIT RESILIENT NEXT GENERATION TRANSIT FACILITY PLAN
	WSP 1000 PERRY AVE MARTIN LUTHER KING JR. BLDG TEL: (916) 984-9000 FAX: (916) 984-9004
DRAWING TITLE	SITE 3 TEST FIT OPTION 1a
DRAWING NUMBER	3.1a

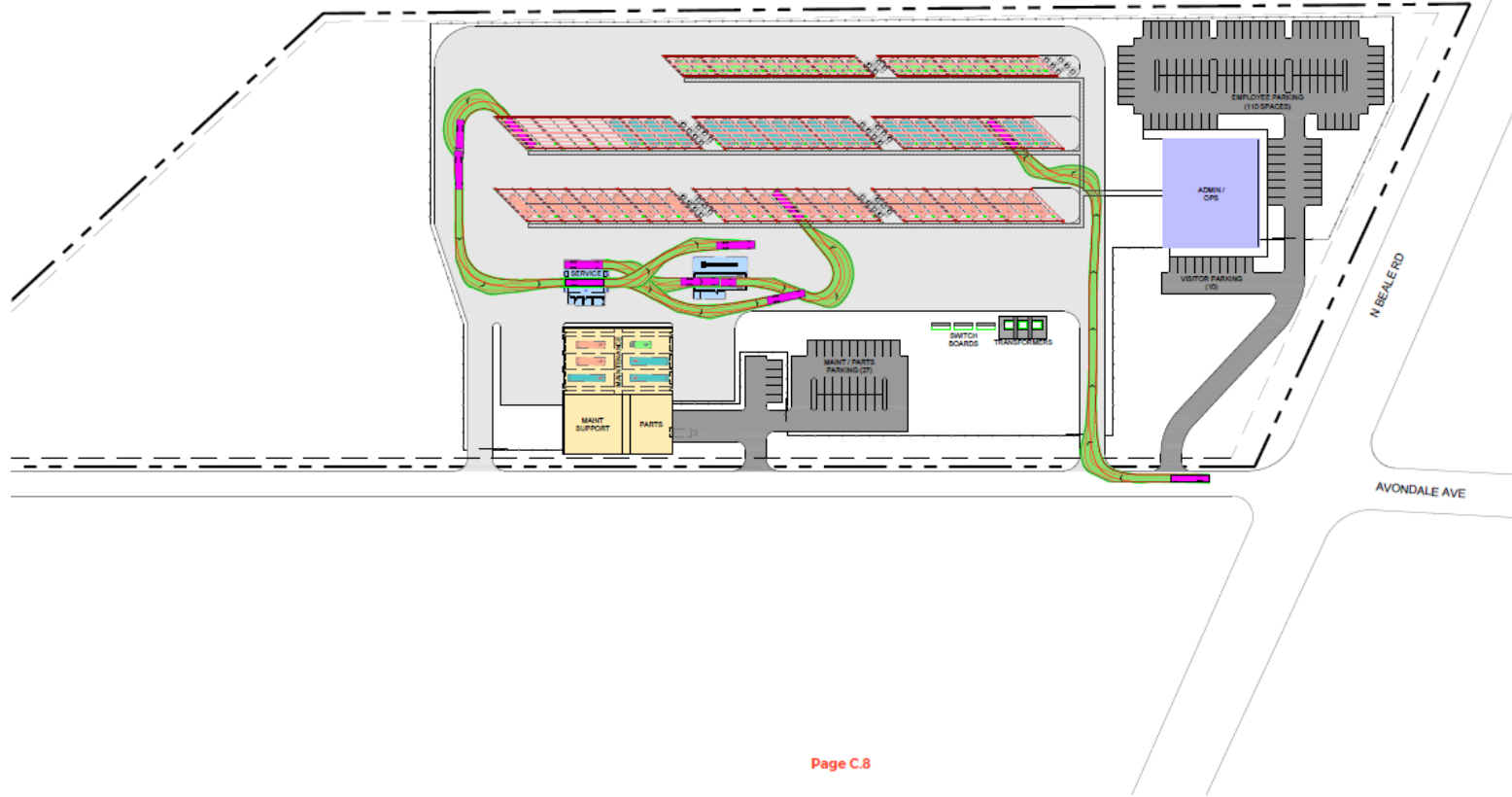

Page C.8

DRAWING NUMBER <b>3.1a</b>	DRAWING TITLE <b>SITE 3 TEST FIT OPTION 1a VEH. CIRCULATION</b>	 WSP USA, INC. 1000 PARK ROW HAYWARD, CALIF 94541 TEL: (925) 961-9999 FAX: (925) 961-9994		PROJECT NO. 1825A
				PROJECT TITLE <b>YUBA-SUTTER TRANSIT          RESILIENT NEXT GENERATION          TRANSIT FACILITY PLAN</b>
				DRAWN BY RR
				DATE 6/6/2020
				SCALE AS SHOWN
				DATE 11.11.17
				SCALE 1" = 132'-0"





Page C.9

DRAWING NUMBER	3.1a
DRAWING TITLE	SITE 3 TEST FIT OPTION 1a WITH AERIAL
	
WSP USA INC. 10000 WILSON AVENUE SUITE 200 TEL: (916) 840-0000 FAX: (916) 298-8566	
	
PROJECT TITLE	YUBA-SUTTER TRANSIT RESILIENT NEXT GENERATION TRANSIT FACILITY PLAN
PROJECT NO.	18218A
DRAWN BY	RJR
DATE	04/02/20
SCALE	AS SHOWN 1" = 100'-0"





Page C.10

DRAWING NUMBER	3.1b	DRAWING TITLE	SITE 3 TEST FIT OPTION 1b			PROJECT TITLE	YUBA-SUTTER TRANSIT RESILIENT NEXT GENERATION TRANSIT FACILITY PLAN	PROJECT NO.	18215A
				WSP USA, Inc. 1100 PARK ROW SUITE 200 HAWAII, TEXAS 75044 TEL: (972) 960-9000 FAX: (972) 750-9104				DRAWN BY	RR
								DATE	6/20/20
								SCALE	3/8" = 1' - 0/8"
									1/4" = 1' - 0/8"

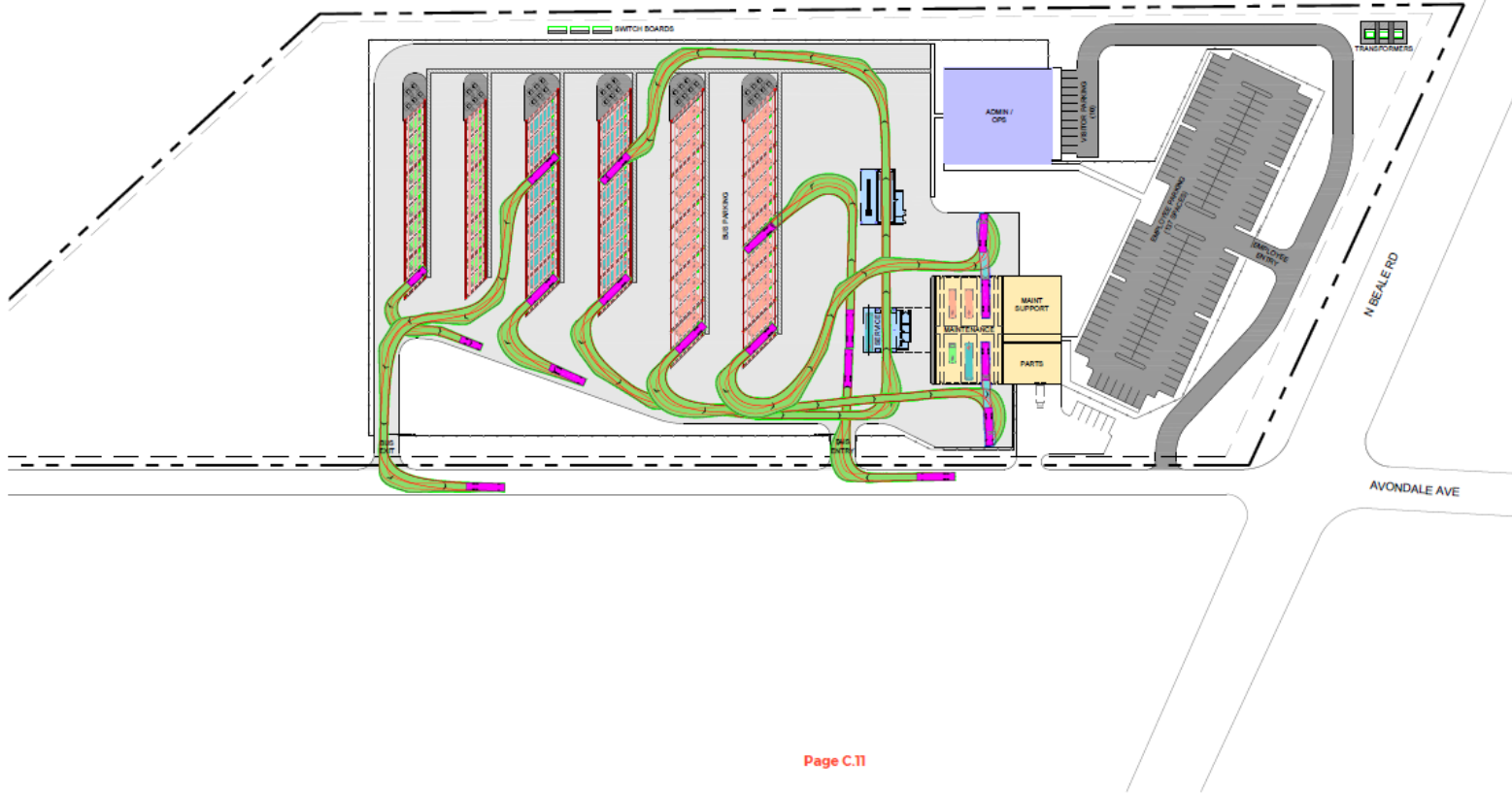

Page C.11

DRAWING NUMBER	3.1b	DRAWING TITLE	SITE 3 TEST FIT OPTION 1b VEH. CIRCULATION	 WSP INC. 1400 DAKOTA SUITE 200 WORTH, TEXAS 75084 TEL: (972) 948-9000 FAX: (972) 750-6100	 PROJECT TITLE YUBA-SUTTER TRANSIT RESILIENT NEXT GENERATION TRANSIT FACILITY PLAN	PROJECT NO. 19225A DRAWN BY RIR DATE 6/30/2020 SCALE 25000 1" = 60'-0" 11x17 1" = 120'-0"
----------------	------	---------------	--	---	---	---

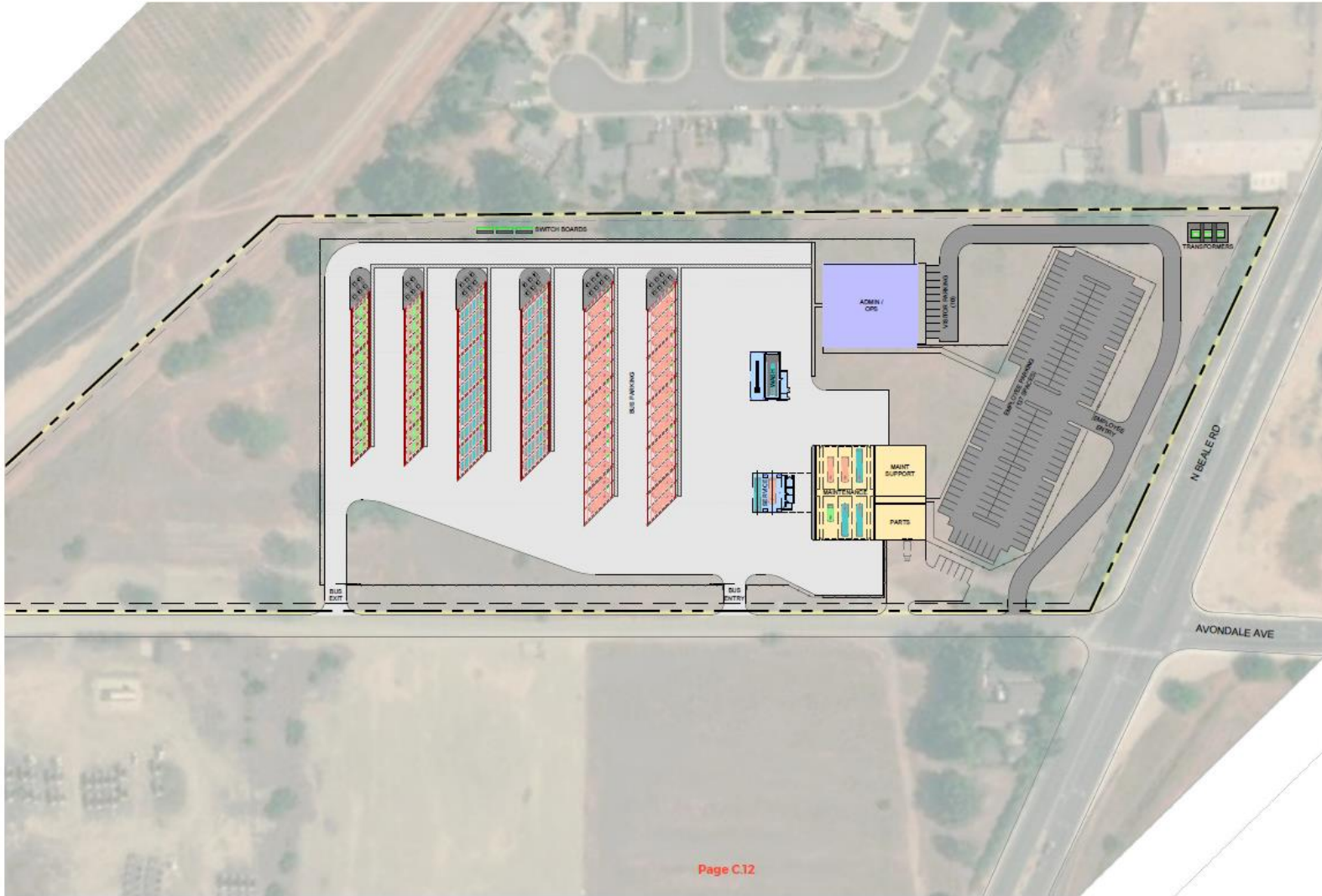

Page C.12

DRAWING NUMBER <b>3.1b</b>	DRAWING TITLE <b>SITE 3 TEST FIT OPTION 1b WITH AERIAL</b>	 WSP USA, INC. 1000 PARK ROW FOLSOM, CALIFORNIA 95630 TEL: (916) 788-0900 FAX: (916) 788-0904	 <b>Yuba-Sutter Transit</b>	PROJECT TITLE YUBA-SUTTER TRANSIT RESILIENT NEXT GENERATION TRANSIT FACILITY PLAN	PROJECT NO. 18275A
				DRAWN BY BR DATE 6/30/2020 SCALE 1" = 60.0' 1" = 120.0'	

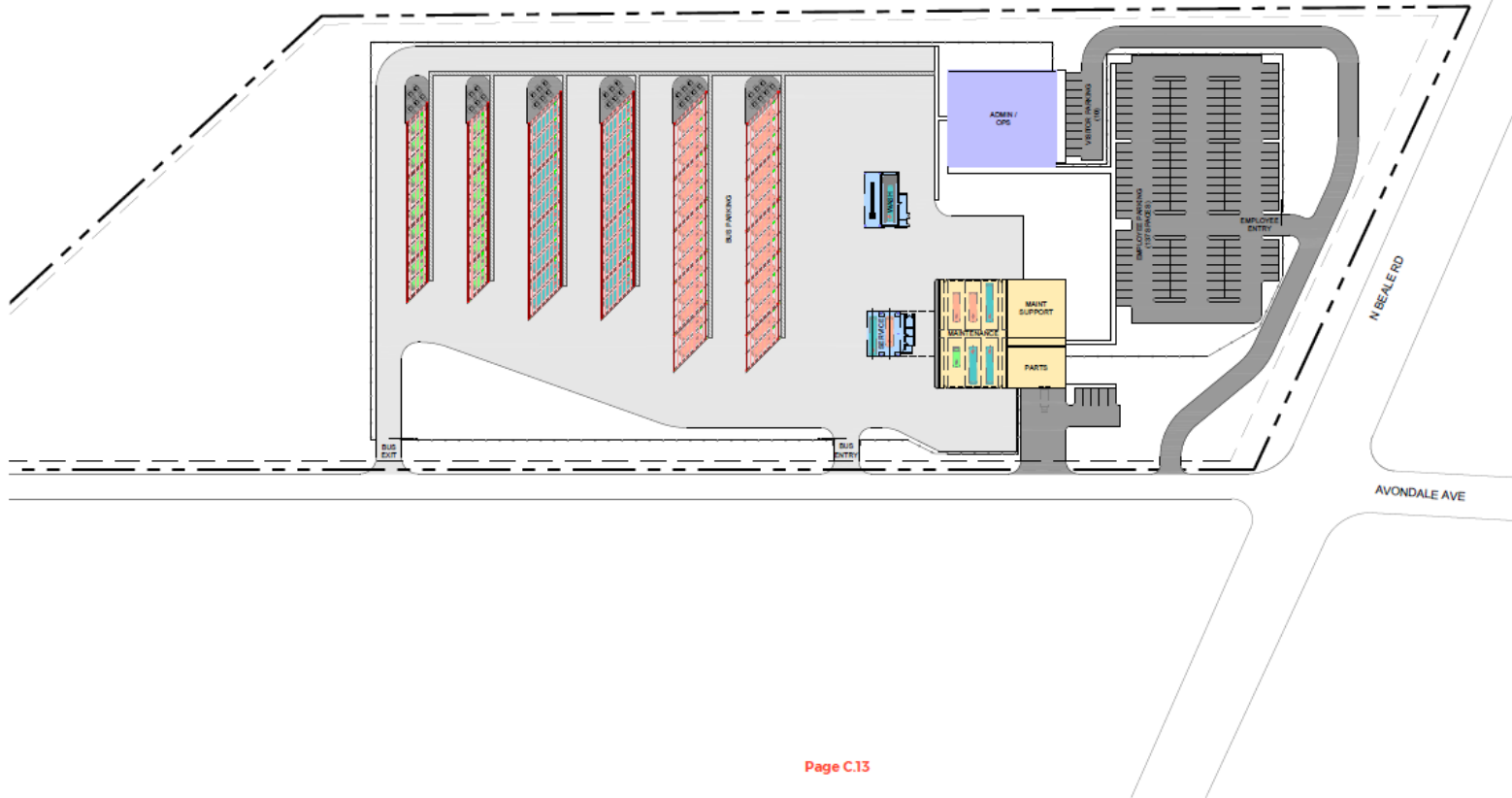

Page C.13

DRAWING NUMBER	DRAWING TITLE	WSP USA, INC. 1000 PARK ROW HAUNTON, TEXAS 77044 TEL: (281) 961-0000 FAX: (281) 961-0004			PROJECT NO.	18251A
					PROJECT TITLE	YUBA-SUTTER TRANSIT RESILIENT NEXT GENERATION TRANSIT FACILITY PLAN
3.1c	SITE 3 TEST FIT OPTION 1c				DRAWN BY	RR
					DATE	6/05/2020
					SCALE	20x4 1" = 60'-0" 11x17 1" = 120'-0"

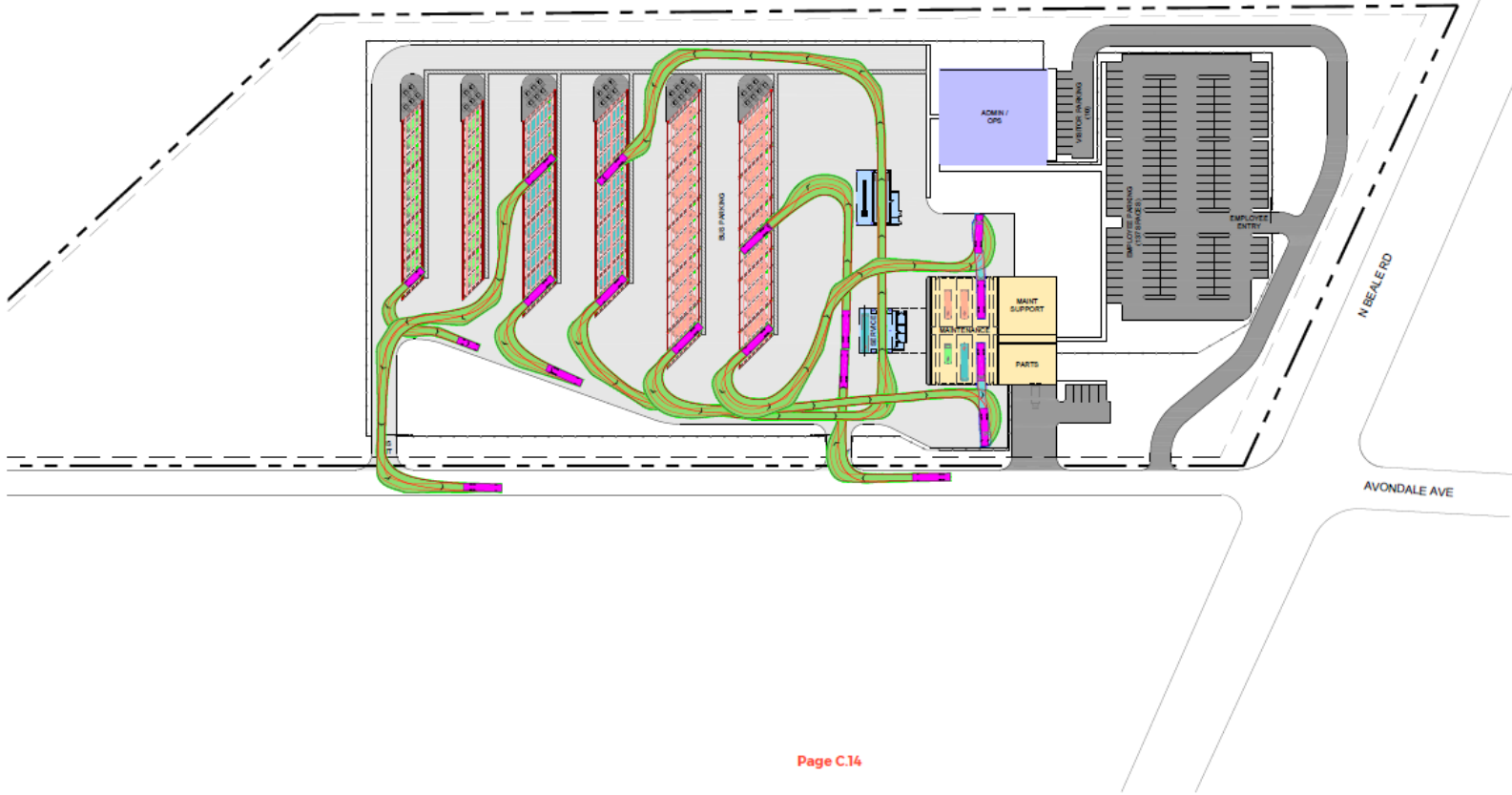

DRAWING NUMBER	3.1c	DRAWING TITLE	SITE 3 TEST FIT OPTION 1c VEH. CIRCULATION	 WSP USA INC. 10000 WILSON BLVD SUITE 200 TRUCKEE, CALIFORNIA 99574 TEL: (877) 835-6888 FAX: (877) 786-8166	 Yuba-Sutter Transit RESILIENT NEXT GENERATION TRANSIT FACILITY PLAN	PROJECT NO. 18215A DRAWN BY RR DATE 06/29/20 SCALE 1/8" = 1'-0"
----------------	------	---------------	--	--	--	--



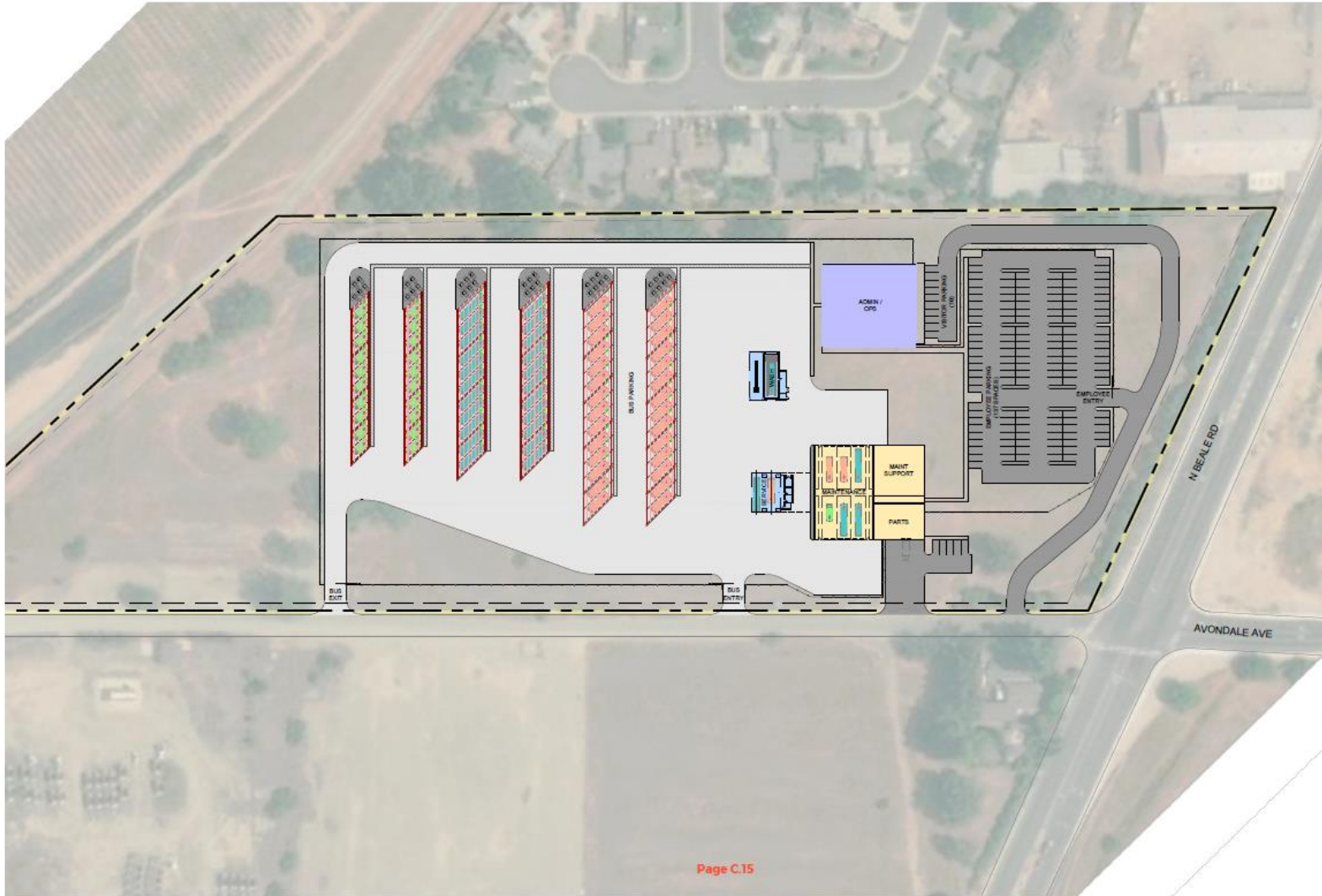

Page C.15

DRAWING NUMBER <b>3.1c</b>	DRAWING TITLE <b>SITE 3 TEST FIT OPTION 1c WITH AERIAL</b>	 WSP USA INC. 16200 PARKWAY SUITE 100 MARYSVILLE, TEXAS 77044 TEL: (281) 988-8888 FAX: (281) 988-8886	 <b>Yuba-Sutter Transit</b>	PROJECT NO. 180256A
				PROJECT TITLE <b>YUBA-SUTTER TRANSIT RESILIENT NEXT GENERATION TRANSIT FACILITY PLAN</b>
				DRAWN BY BRI
				DATE 6/20/2020
				SCALE 200X 1" = 60'-0" 11x17 1" = 120'-0"

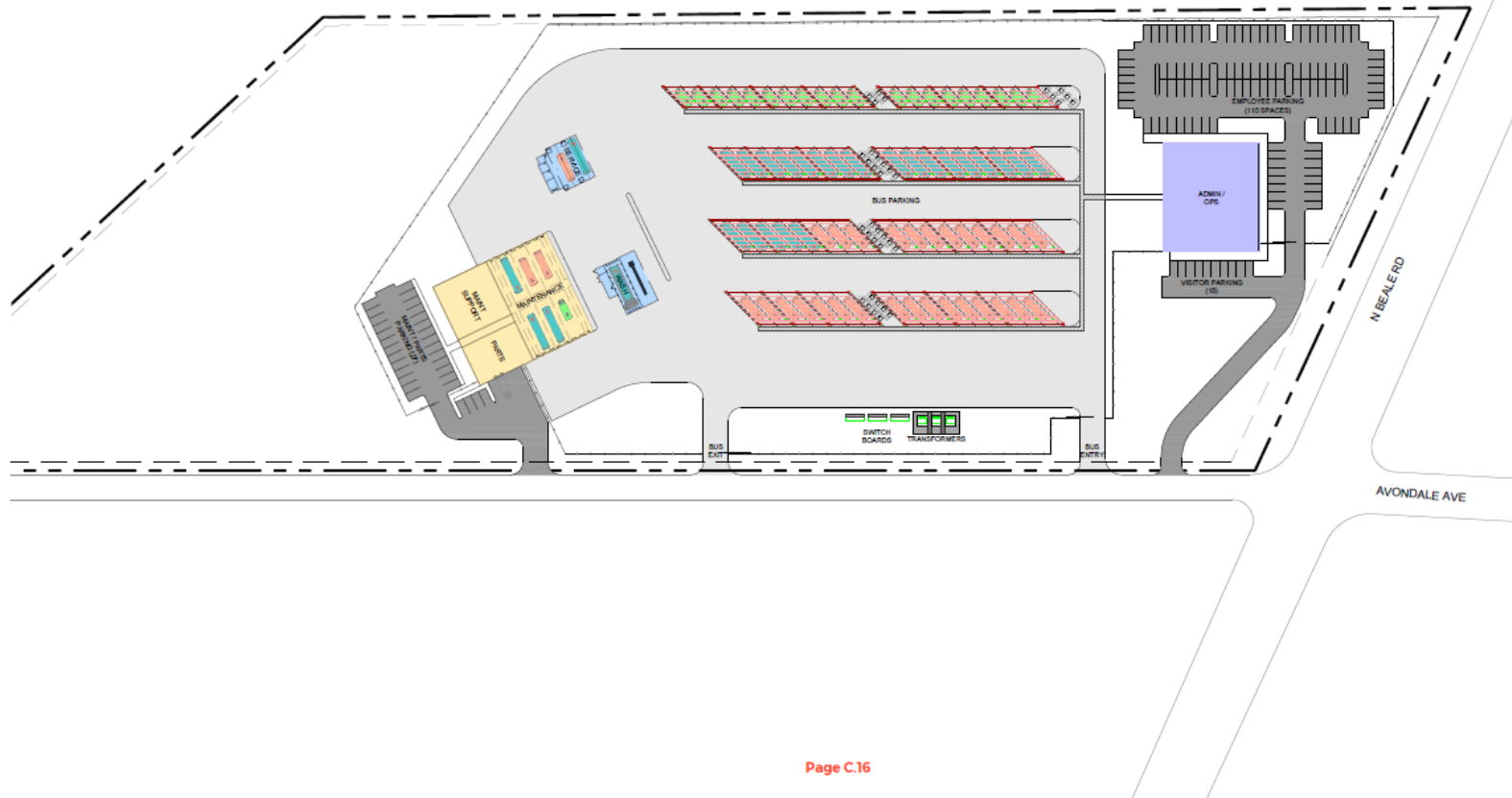

Page C.16

DRAWING NUMBER	3.2	DRAWING TITLE	SITE 3 TEST FIT OPTION 2	 WSP USA INC. 5011 KENTWOOD BLVD SUITE 200 MARYSVILLE, CA 95901 TEL: (916) 796-0000 FAX: (916) 796-0104	 PROJECT TITLE YUBA-SUTTER TRANSIT RESILIENT NEXT GENERATION TRANSIT FACILITY PLAN	PROJECT NO. 18215A DRAWN BY RR DATE 4/23/2020 SCALE 1/4" = 1'-0" 1/8" = 1'-0" 1/16" = 1'-0"
----------------	-----	---------------	-----------------------------	--	---	--

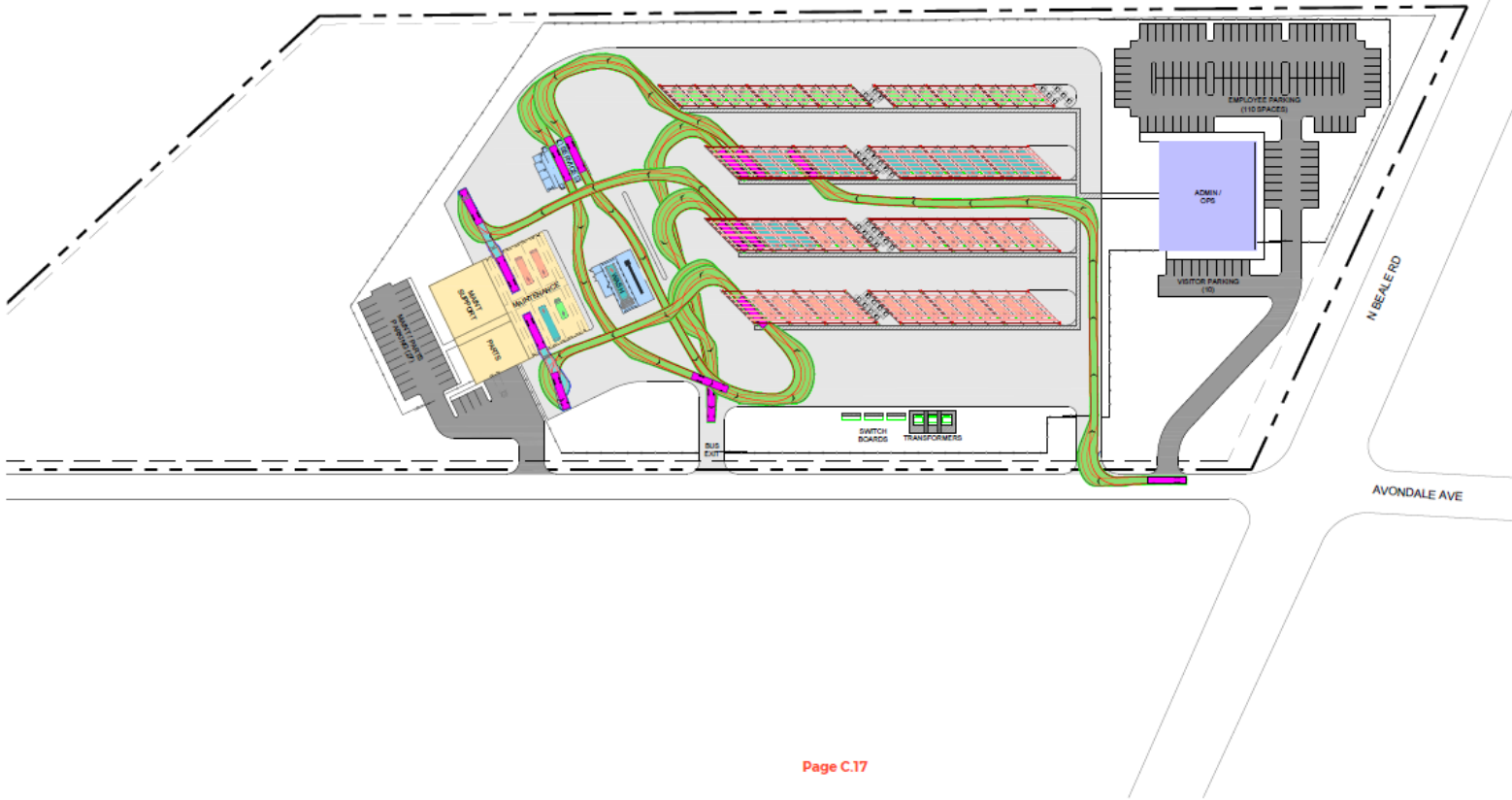

Page C.17

DRAWING NUMBER	DRAWING TITLE	WSP USA INC. 18001 PARK ROW MARIETTA, TEXAS 77654 TEL: (817) 798-0100 FAX: (817) 798-0100			PROJECT NO.	18215A
					PROJECT TITLE	YUBA-SUTTER TRANSIT RESILIENT NEXT GENERATION TRANSIT FACILITY PLAN
3.2	SITE 3 TEST FIT OPTION 2 VEH. CIRCULATION				DRAWN BY	RR
					DATE	6/21/2020
					SCALE	1" = 60'-0" 1/4" = 1'-0"-0"





Page C.18

DRAWING NUMBER	DRAWING TITLE	PROJECT TITLE	PROJECT NO.	18275A
			DRAWN BY	RR
3.2	SITE 3 TEST FIT OPTION 2 WITH AERIAL	Yuba-Sutter Transit	DATE	6/21/2020
			SCALE	20M 1" = 60'-0" 11X17 1" = 15'-0"





Page C.19

DRAWING NUMBER	DRAWING TITLE	PROJECT TITLE	PROJECT NO.	18215A
			DRAWN BY	RR
7.1	SITE 7 TEST FIT	Yuba-Sutter Transit Resilient Next Generation Transit Facility Plan	DATE	7/6/2020
			SCALE	200% 1" = 60'-0" 11 X 17 1" = 120'-0"



WSP USA INC.  
 10000 SUTTER BLVD  
 SUITE 200  
 YUBA, CA 95904  
 TEL: (916) 924-7900  
 FAX: (916) 795-0104

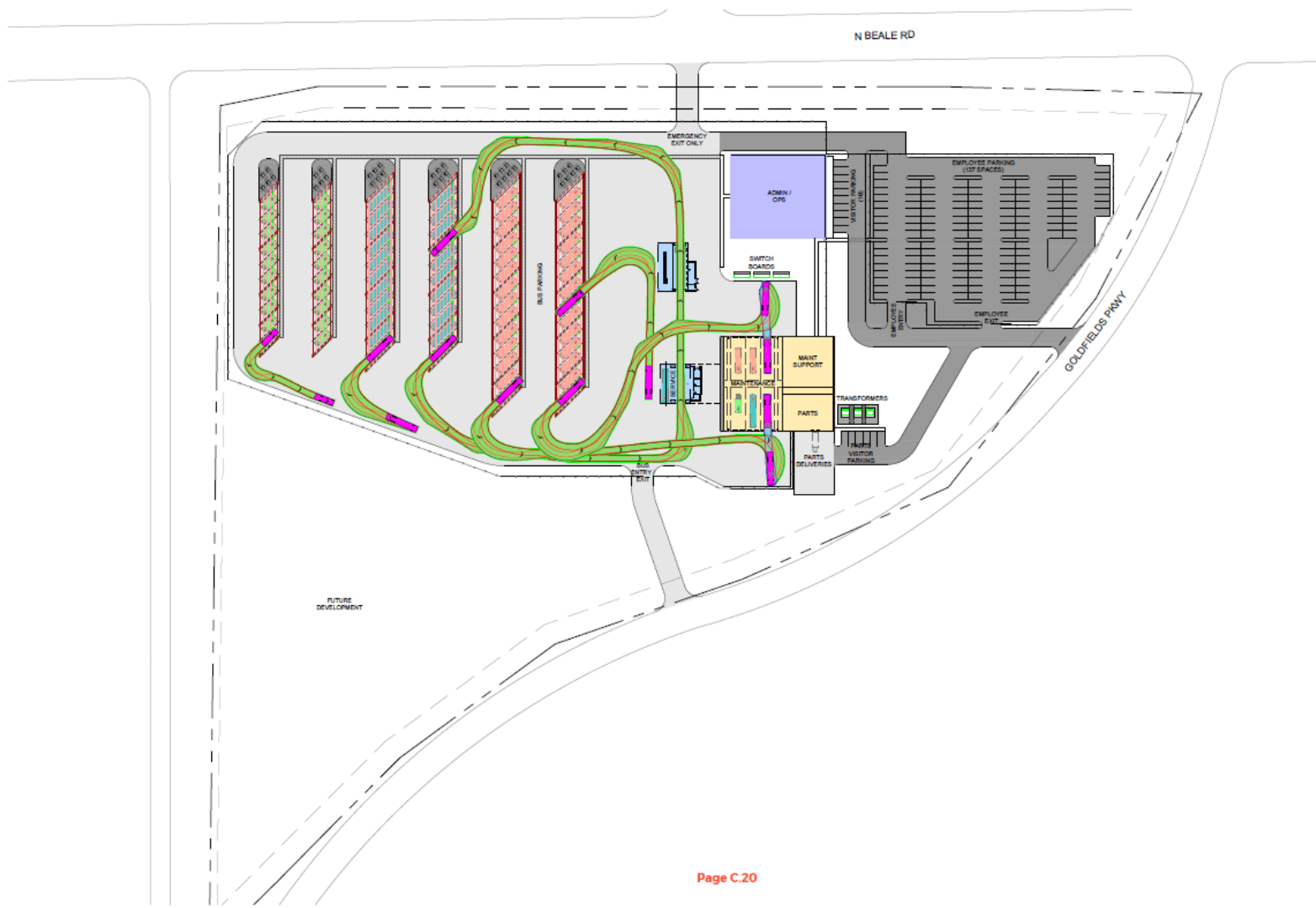

Page C.20

DRAWING NUMBER	DRAWING TITLE	 WSP USA, INC. 1000 PARK ROW SUITE 100 MARYSVILLE, TEXAS 77454 TEL: (817) 939-9000 FAX: (817) 758-0500		PROJECT NO.	18215A
				PROJECT TITLE	YUBA-SUTTER TRANSIT RESILIENT NEXT GENERATION TRANSIT FACILITY PLAN
7.1	SITE 7 TEST FIT VEH. CIRCULATION			DRAWN BY	RJR
				DATE	7/20/20
				SCALE	2004 1" = 60'-0" 11.1.17 1" = 120'-0"



DRAWING NUMBER	7.1	WSP USA INC. 1000 WASHINGTON IRVING, TEXAS 75039 PH: (972) 786-5166		Yuba-Sutter Transit TRANSIT FACILITY PLAN	PROJECT NO DRAWN BY DATE	18215A RR 7/2020
DRAWING TITLE	SITE 7 TEST FIT WITH AERIAL			YUBA-SUTTER TRANSIT RESILIENT NEXT GENERATION TRANSIT FACILITY PLAN	PROJECT NO DRAWN BY DATE	18215A RR 7/2020
					SCALE	1" = 60' 0" 1/4" = 150'



Page C.22

PROJECT TITLE	PROJECT NO.	18215A
YUBA-SUTTER TRANSIT RESILIENT NEXT GENERATION TRANSIT FACILITY PLAN	DRAWN BY	RR
	DATE	6/23/2020
WSP USA, Inc. 1000 PARK ROW MILFORD, MASSACHUSETTS 01875 TEL: (978) 681-0900 FAX: (978) 681-0904	SCALE	2004 1" = 60'-0" 1:1.17 1" = 135'-0"
DRAWING TITLE	SITE 11 TEST FIT	
DRAWING NUMBER	11	





Page C.23

DRAWING NUMBER	11	DRAWING TITLE	SITE 11 TEST FIT VEH. CIRCULATION	WSP USA, INC. 1000 W. HUNTER ROAD SUITE 200 MARTINEZ, CA 94553 TEL: (925) 786-5100 FAX: (925) 786-5100		PROJECT TITLE	YUBA-SUTTER TRANSIT RESILIENT NEXT GENERATION TRANSIT FACILITY PLAN		PROJECT NO.	102256A
						DRAWN BY	RR			
						DATE	02/28/20			
						SCALE	1" = 100'-0"			



DRAWING NUMBER	SITE 11 TEST FIT WITH AERIAL		 WSP USA, INC. 4000 PARKWAY SUITE 200 COLTON, CA 95926 TEL: 916.438.0000 FAX: 916.438.1000	 Yuba-Sutter Transit	PROJECT TITLE YUBA-SUTTER TRANSIT RESILIENT NEXT GENERATION TRANSIT FACILITY PLAN	PROJECT NO.	92218A
	DRAWING BY	RR				DATE	02/20/20
	11						11.11.17 1" = 120' 0"

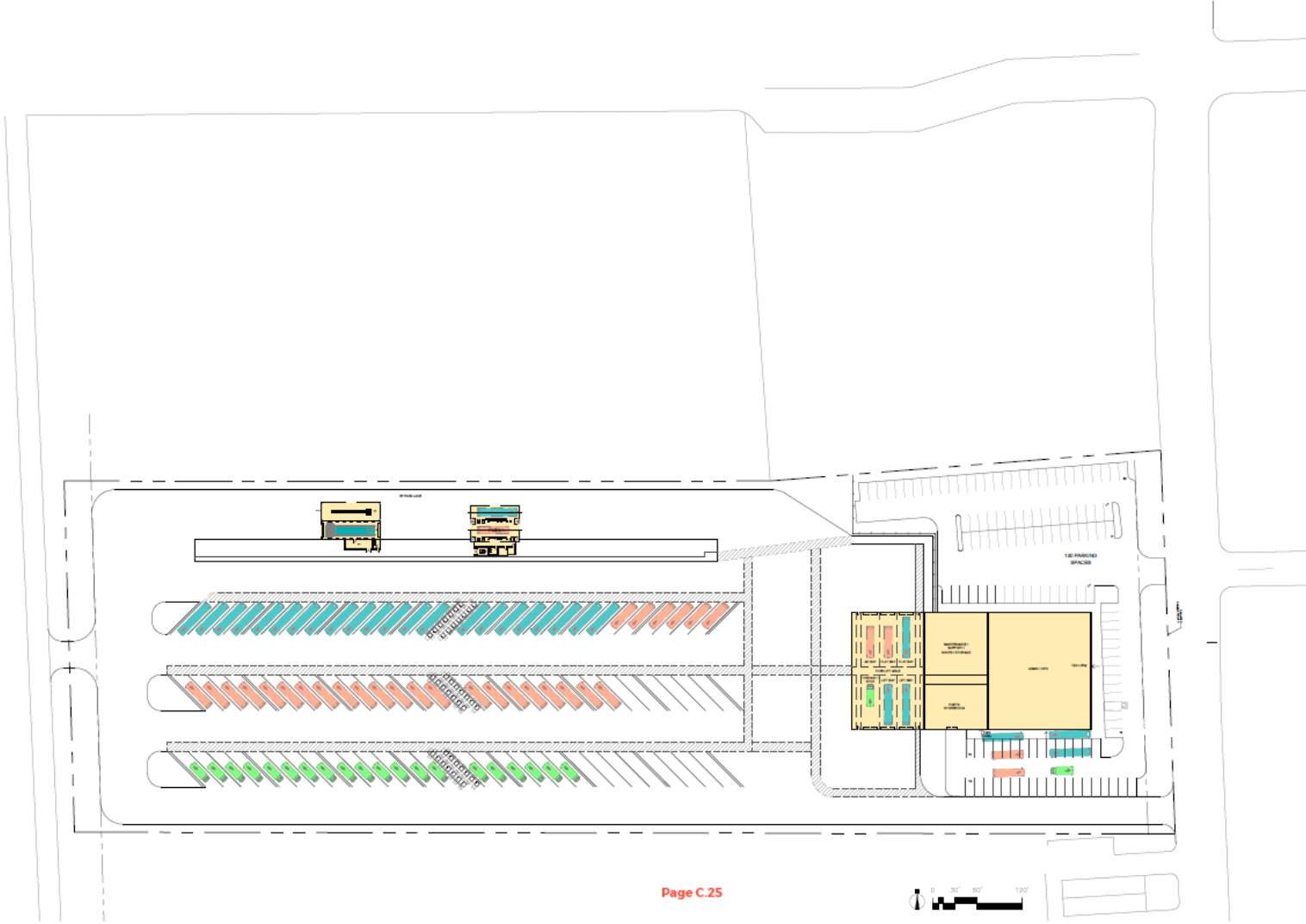

Page C.25

DRAWING NUMBER	12.1A	DRAWING TITLE	SITE 12 TEST FIT TARGET SITE OPTION 1			PROJECT TITLE	YUBA-SUTTER TRANSIT RESILIENT NEXT GENERATION TRANSIT FACILITY PLAN	PROJECT NO.	9925A
				WSP INC. 1600 PARKWAY SUITE 100 COLTON, TEXAS 77048 TEL: 409-338-0800 FAX: 409-338-1006			DESIGNER	JAC	
							DATE	07/02/2020	
							SCALE	AS SHOWN 1" = 50'-0" 1/4" = 100'-0"	



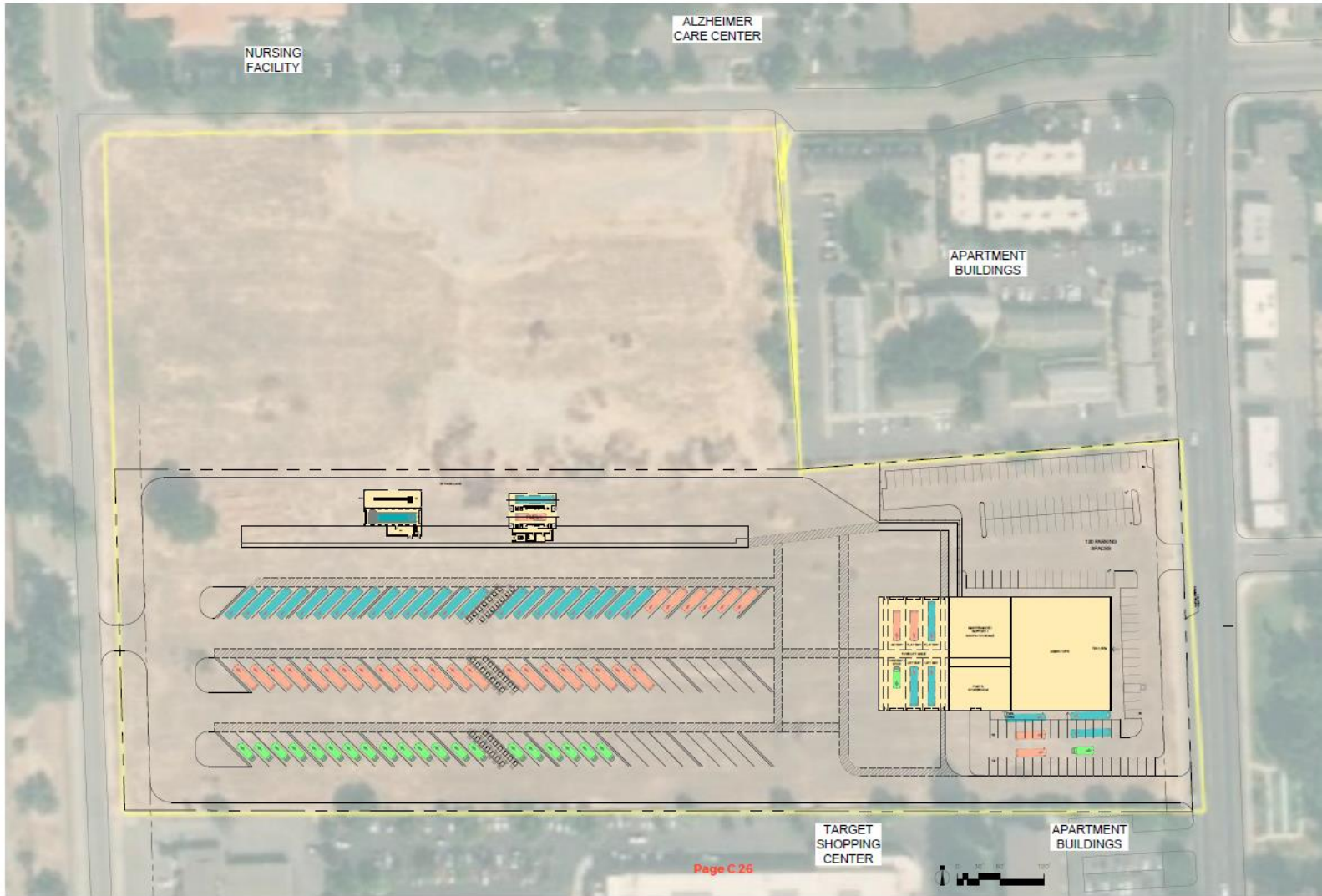

DRAWING NUMBER	12.1A
DRAWING TITLE	SITE 12 TEST FIT TARGET SITE OPTION 1 - W/ AERIAL
	
	WSP USA, INC. 10000 W. HIGHTWAY SUITE 500 HOUSTON TEXAS 77064 PHONE: (281) 784-5000 FAX: (281) 784-5004
	
PROJECT TITLE	YUBA-SUTTER TRANSIT RESILIENT NEXT GENERATION TRANSIT FACILITY PLAN
PROJECT NO.	90265A
DRAWN BY	JVC
DATE	09/08/2010
SCALE	1" = 100.0'

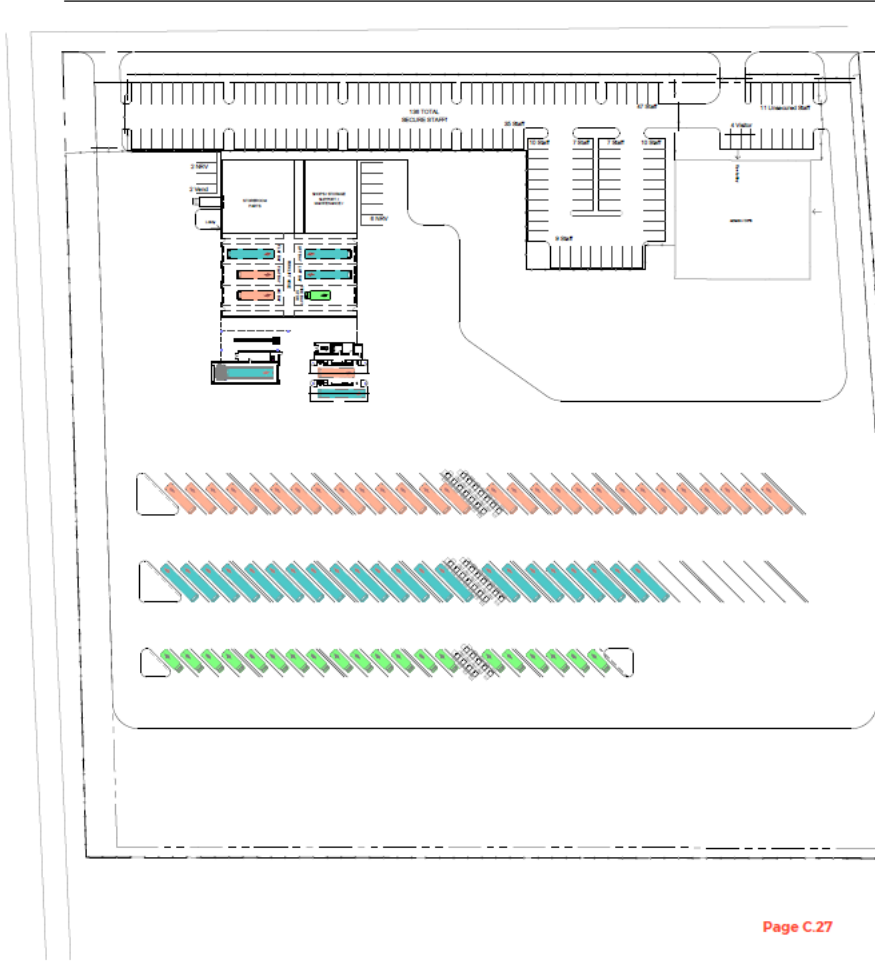

Page C.27



DRAWING NUMBER	DRAWING TITLE	PROJECT TITLE	PROJECT NO.	9525A
			DRAWN BY	JAC
12.1B	SITE 12 TEST FIT TARGET SITE OPTION 2	Yuba-Sutter Transit Resilient Next Generation Transit Facility Plan	DATE	01/02/20
			SCALE	2008 1" = 50.0' 11/11 1" = 100'
 WSP USA, INC. 10000 PARKWAY HOUSTON, TEXAS 77036 TEL: (281) 798-5100 FAX: (281) 798-5104		 Yuba-Sutter Transit	DATE	11/11
			SCALE	1" = 100'

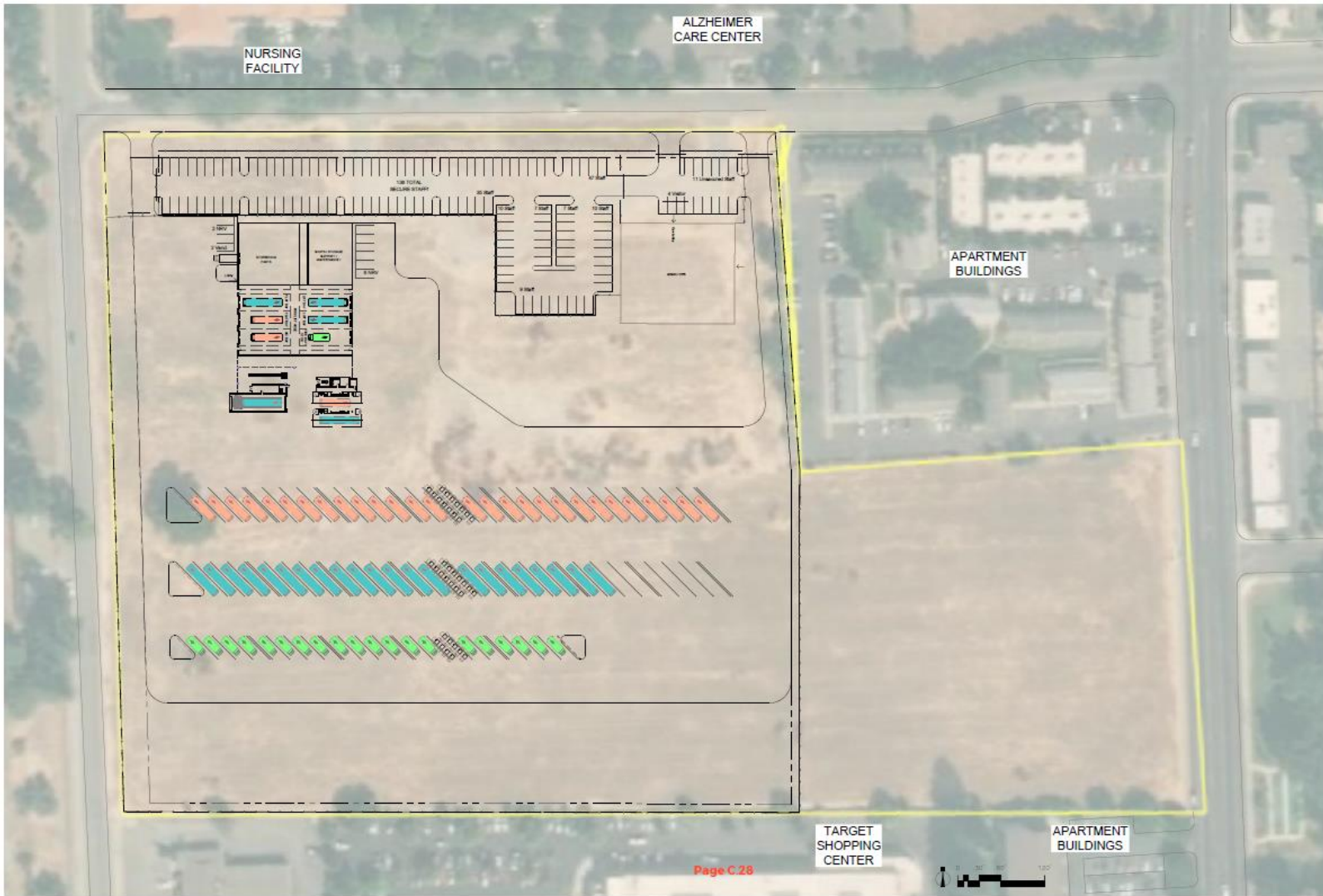

DRAWING NUMBER	12.1B	DRAWING TITLE	SITE 12 TEST FIT TARGET SITE OPTION 2 - W/ AERIAL	 WESTON PARK 4000 PARK ROW HOUSTON, TEXAS 77064 TEL: 281.258.8800 FAX: 281.258.8806		PROJECT TITLE	YUBA-SUTTER TRANSIT RESILIENT NEXT GENERATION TRANSIT FACILITY PLAN	PROJECT NO.	9925EA
	DESIGNED BY		JAC				DATE		01/10/2020

# APPENDIX D GREENFIELD SITES AND BUILDING LAYOUTS

---

## INTRODUCTION

The following pages show the Greenfield Sites which were idealized site layouts to be used as a basis and reference for viable sites selected by Yuba-Sutter Transit to be considered for test fits. The Greenfield Site configurations were then modified as needed for each test fit site, found in Appendix C.

The following pages also contain the Operations & Administration, Maintenance, and Parts Storeroom building layout options. Each of these functions were housed in a single-story building based on the square footage per the Preliminary Space Needs Program. During the Design Workshop with Yuba-Sutter Transit, it was determined that the most viable solution for the layout of the site, Operations functionality, and accessibility around the site, that a separate building for Administration & Operations and for Maintenance & the Parts Storeroom was the best solution. The separation of the buildings is represented in Appendix C on the Site Test Fits.

### Greenfield Sites:

Note: Maintenance and Operations Building 2A is indicated on all Greenfield site plans.

OPT 1, SP1 45 Degree Double Loaded Pull-In Parking

OPT 1, SP2 45 Degree Double Loaded Pull-In Parking Circulation (Indicates circulation patterns of buses around site)

Site is designed to have buses pull in and park at a 45-degree angle, then back out to circulate around through Fuel & Wash and to leave the site for bus routes.

OPT 2, SP3 45 Degree Double Loaded Back-In Parking

OPT 2, SP4 45 Degree Double Loaded Back-In Parking Circulation (Indicates circulation patterns of buses around site)

Site is designed to have buses back in and park at a 45-degree angle, then drive out to circulate around through Fuel & Wash and to leave the site for bus routes.

OPT 3, SP5 45 Degree Single Loaded Pull-Thru Parking

OPT 3, SP6 45 Degree Single Loaded Pull-Thru Parking Circulation (Indicates circulation patterns of buses around site)

Site is designed to have buses pull in and park at a 45-degree angle, then pull through to circulate around through Fuel & Wash and to leave the site for bus routes.

OPT 4, SP7 90 Degree Double Loaded Pull-In Parking

OPT 4, SP8 90 Degree Double Loaded Pull-In Parking Circulation (Indicates circulation patterns of buses around site)

Site is designed to have buses pull in and park at a 90-degree angle, then back out to circulate around through Fuel & Wash and to leave the site for bus routes.

OPT 5, SP9 90 Degree Double Loaded Back-In Parking

OPT 5, SP10 90 Degree Double Loaded Back-In Parking Circulation (Indicates circulation patterns of buses around site)

Site is designed to have buses back in and park at a 90-degree angle, then pull out to circulate around through Fuel & Wash and to leave the site for bus routes.

SP11 Site Plan Track Parking

Site is designed to have buses pull in and park nose to tail, two buses deep. The intent is for the buses in front to pull out first and circulation through Fuel & Wash as the bus behind is moved forward. The bus in front would also leave first for bus routes.



### **Fuel & Wash Building Layouts**

#### **A.4 Fuel Lanes**

Two fuel positions to accommodate both 35-foot and 45-foot diesel buses for the duration of time until the entire fleet is converted to Zero Emission Buses (ZEBs). Facilities at the Fuel Lanes include a Unisex Restroom, Utility Workstation, Cleaning Storage, and Central Vacuum. After the entire fleet of buses is converted to ZEBs the Fuel Lanes can continue to be utilized for interior clean lanes.

#### **A.5 Drive-Thru Wash / Chassis Wash**

One drive through Bus Wash gantry style washer position and one Chassis Wash position with a Water Reclaim room and Chassis Wash Equipment room. The gantry wash position will accommodate all bus types in the Yuba-Sutter Transit fleet.

**AGENCY VEHICLE COUNT**

45 Buses	22
35 Buses	28
24' to 25' Buses	20
<b>TOTAL:</b>	<b>70</b>

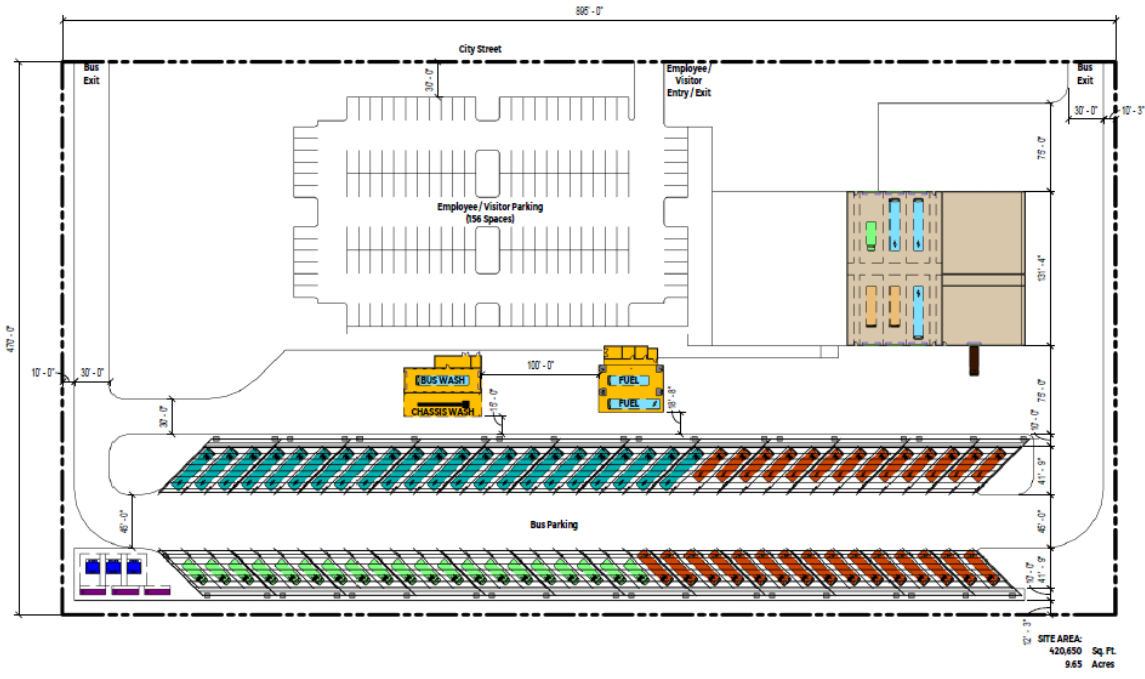



Page D.5

BIM 360/JHOU-193215A - YUBA SUTTER NEXT GEN BEB OMF 2019 - R19/Yuba-Sutter Greenfield.rvt

DRAWING NUMBER	OPT 1	DRAWING TITLE	PROJECT TITLE	PROJECT NO.	193215A
	SP1				193215A
45 Degree Double Loaded Pull-In Parking		Yuba-Sutter Transit Resilient Next Generation Transit Facility Plan	Yuba-Sutter Transit	DRAWN BY	Alamy
				DATE	08/11/2020
				SCALE	1" = 40'-0"



8/20/2020 4:19:24 PM

**AGENCY VEHICLE COUNT**

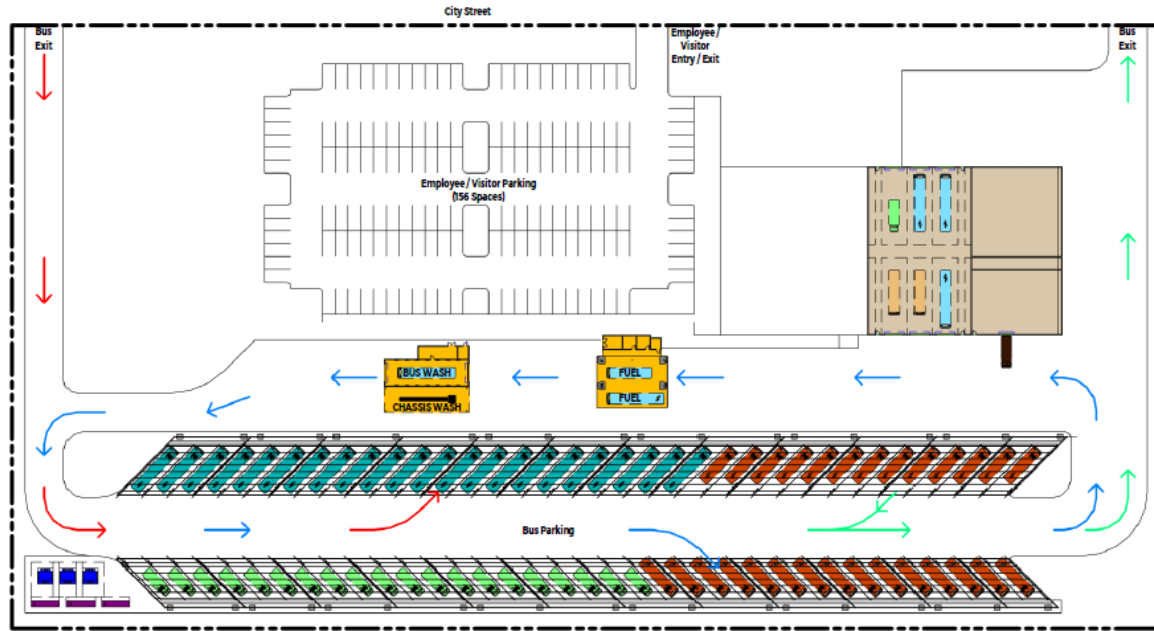
45 Buses		22
35 Buses		28
24 to 25 Buses		20
<b>TOTAL:</b>		<b>70</b>





**CIRCULATION**

- Inbound 
- Internal 
- Outbound 

DRAWING NUMBER	OPT 1	DRAWING TITLE	45 Degree Double Loaded Pull-in Parking Circulation
	SP2		
WSP   1000 JARVIS CROW SUITE 200   1500 S. 7TH ST. YUBA, CA 95904 TEL: (318) 980-9900 FAX: (318) 785-1504			PROJECT TITLE Yuba-Sutter Transit Resilient Next Generation Transit Facility Plan
PROJECT NO.	80215A		
DESIGN BY	Author	SCALE	1" = 40'
DATE	08/14/2020		

**AGENCY VEHICLE COUNT**

45' Buses		22
35' Buses		28
24' to 25' Buses		20
<b>TOTAL:</b>		<b>70</b>

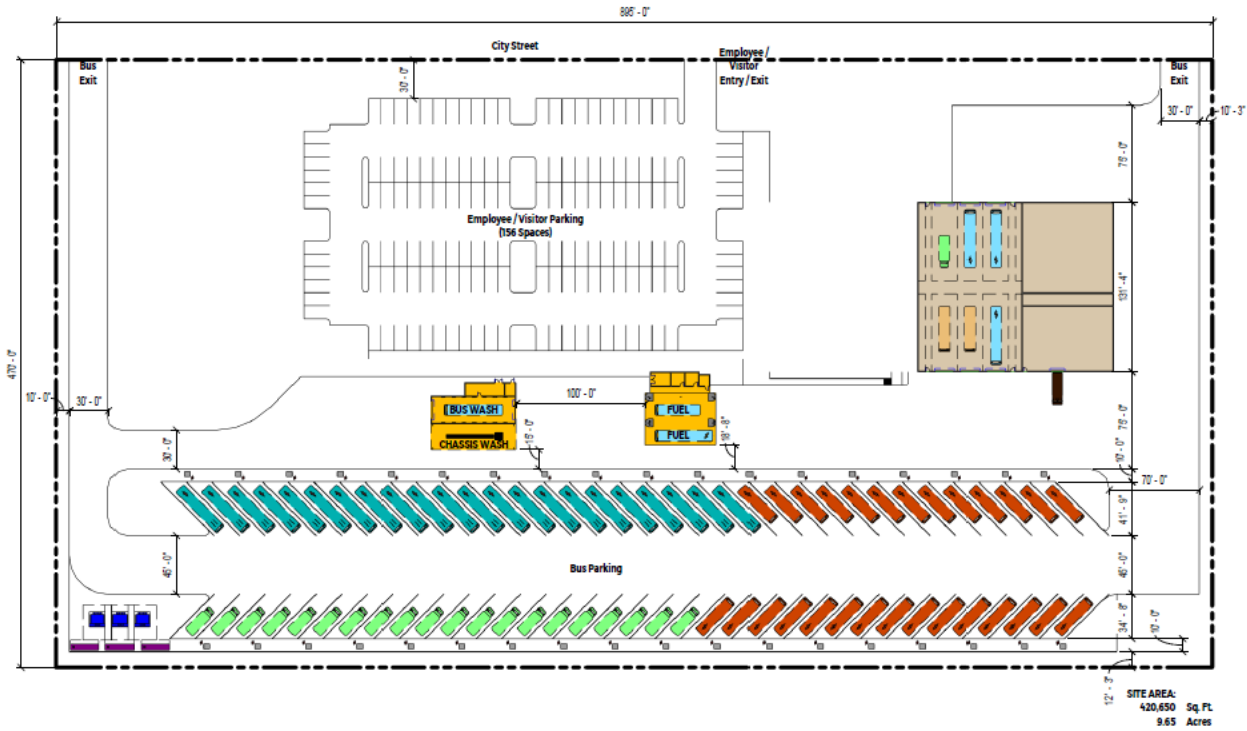

Page D.7

BIM 380.JIHOU-193215A - YUBA SUTTER NEXT GEN BEB OMF 2019 - R19/Yuba-Sutter Greenfield.rvt

DRAWING NUMBER	OPT 2	DRAWING TITLE	45 Degree Double Loaded Back-In Parking	PROJECT TITLE	Yuba-Sutter Transit Resilient Next Generation Transit Facility Plan	PROJECT NO.	193215A
	SP3				DATE		08/15/2020
						DRAWN BY	Author
						SCALE	1" = 40'





WSJ  
 WSP PARTNERS  
 1000 PARKWAY  
 SUITE 200  
 ESCALTON, CA  
 95629  
 TEL: (530) 566-9600  
 FAX: (530) 566-1066

8/20/2020 4:19:26 PM



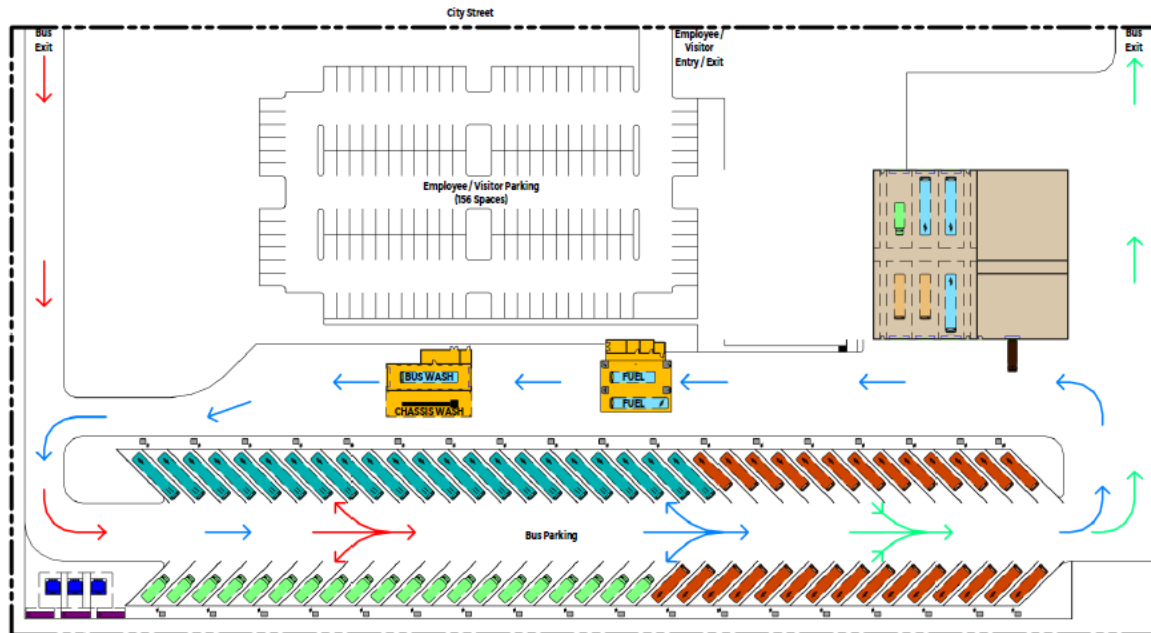

**AGENCY VEHICLE COUNT**

45 Buses		22
35 Buses		28
24 to 25 Buses		20
<b>TOTAL:</b>		<b>70</b>



**CIRCULATION**

- Inbound 
- Internal 
- Outbound 

Page D.8

BIM 360://HOU-193215A - YUBA SUTTER NEXT GEN BEB OMF 2019 - R19/Yuba-Sutter Greenfield.rvt 8/20/2020 4:19:27 PM

DRAWING NUMBER	OPT 2	DRAWING TITLE	45 Degree Double Loaded Back-in Parking Circulation	PROJECT TITLE	Yuba-Sutter Transit Resilient Next Generation Transit Facility Plan	PROJECT NO.	B3275A
	SP4				DRAWN BY		Aubur

**AGENCY VEHICLE COUNT**

45 Buses		22
35 Buses		28
24 to 25 Buses		20
<b>TOTAL:</b>		<b>70</b>

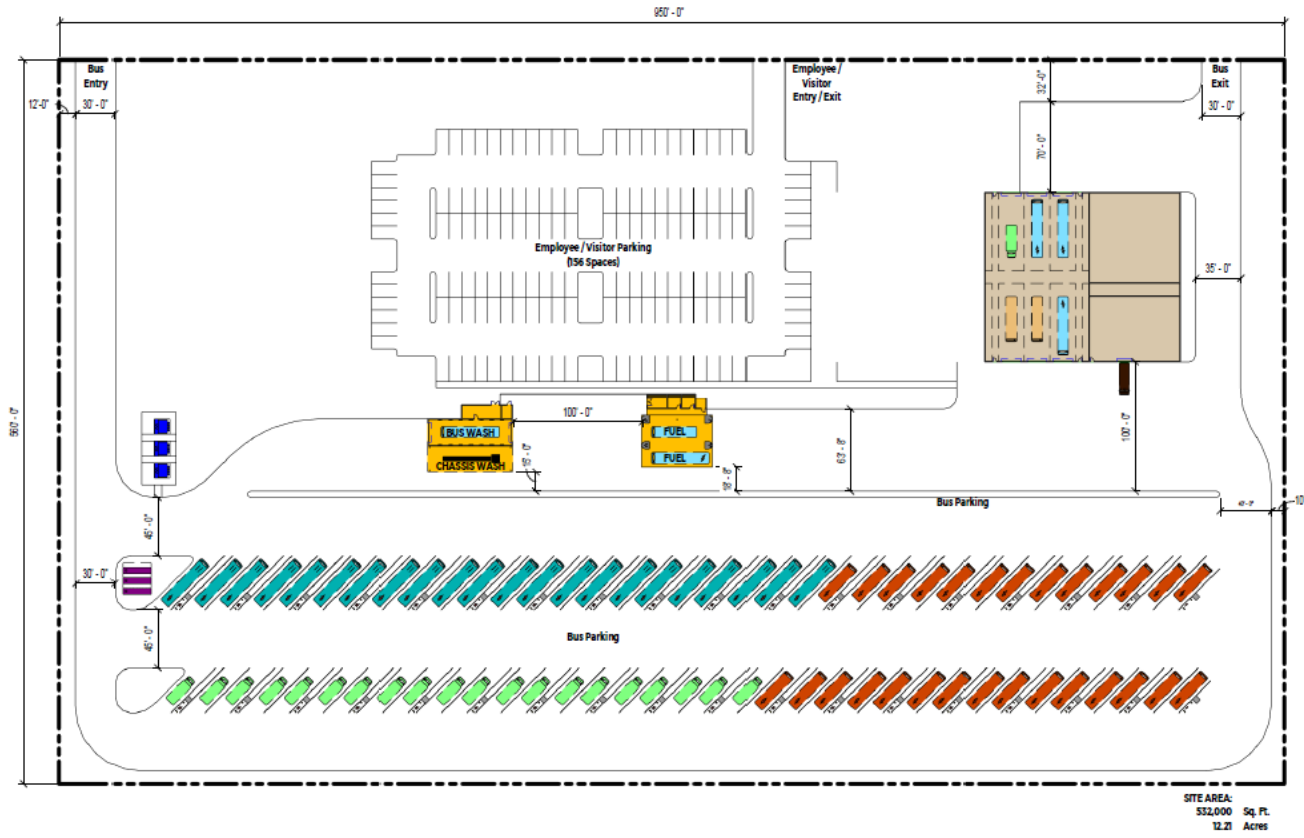

SITE AREA:  
332,000 Sq. Ft.  
12.21 Acres

DRAWING NUMBER	OPT 3 SP5	DRAWING TITLE	45 Degree Single Loaded Pull-Thru Parking		PROJECT TITLE	Yuba-Sutter Transit Resilient Next Generation Transit Facility Plan	PROJECT NO	193215A
				WSP 10300 PARKWAY SUITE 200 MARIETTA, GA 30067 TEL: (770) 998-9900 FAX: (770) 788-5194			DRAWN BY	Autor
							DATE	01/15/2020
							SCALE	1" = 40'-0"

**AGENCY VEHICLE COUNT**

45 Buses	22
35 Buses	28
24 to 25 Buses	20

**TOTAL:** 70

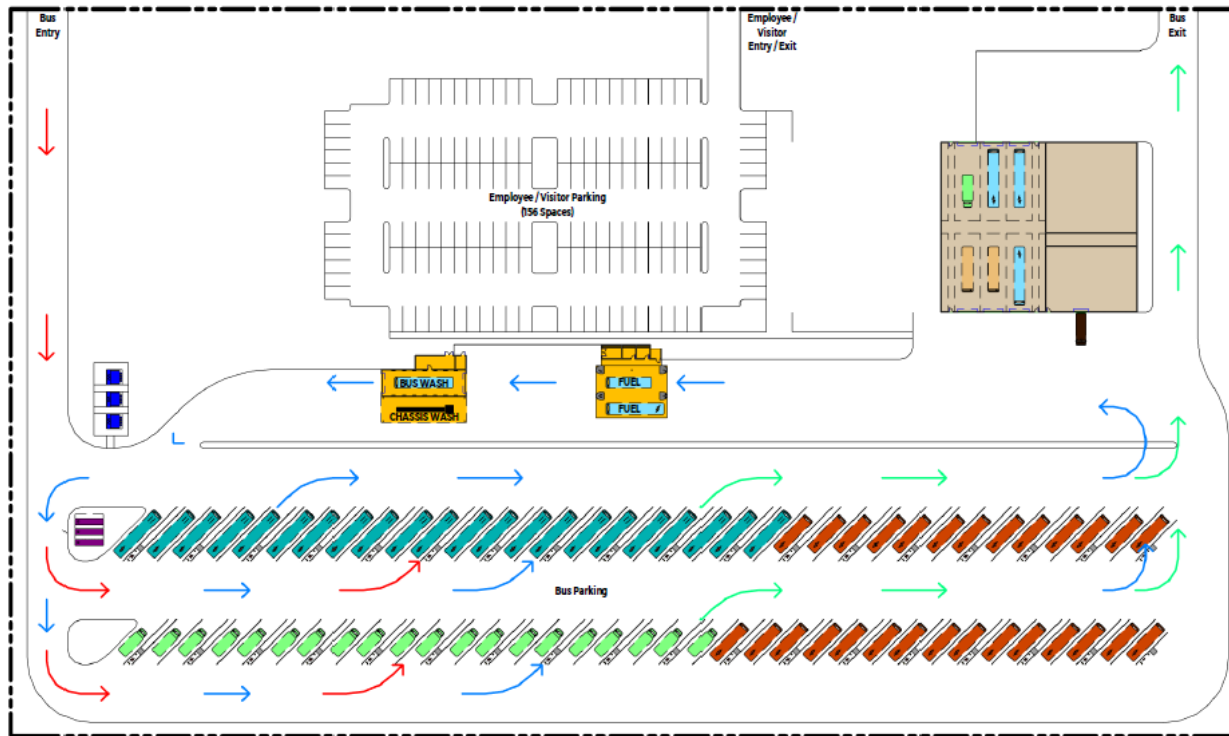

**CIRCULATION**

- Inbound →
- Internal →
- Outbound →



Page D.10

BIM 360://HOU-193215A - YUBA SUTTER NEXT GEN BEB OMF 2019 - R19/Yuba-Sutter Greenfield.rvt

DRAWING NUMBER	OPT 3	DRAWING TITLE	45 Degree Single Loaded Pull-Thru Parking Circulation	PROJECT TITLE	Yuba-Sutter Transit Resilient Next Generation Transit Facility Plan	PROJECT NO.	193215A	
	SP6				Yuba-Sutter Transit		DRAWN BY	Autor
							SCALE	1" = 40'-0"

8/4/2020 1:52:43 PM

**AGENCY VEHICLE COUNT**

45' Buses		22
35' Buses		28
24' to 25' Buses		20

**TOTAL: 70**

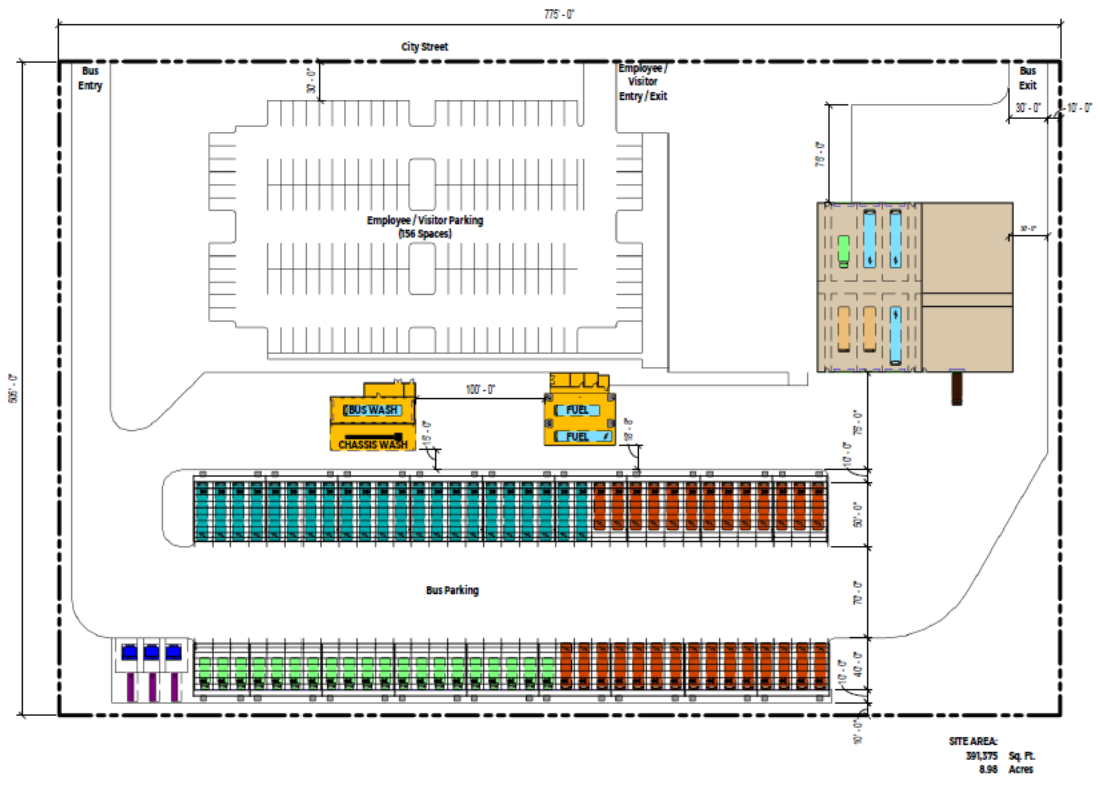

DRAWING NUMBER	OPT 4	DRAWING TITLE	90 Degree Double Loaded Pull-in Parking
	SP7		
			
WSP PARTIAL WSP PARTIAL DATE: 2/20/2018 TEL: (916) 988-9000 FAX: (916) 988-1066		PROJECT TITLE Yuba-Sutter Transit Resilient Next Generation Transit Facility Plan	
PROJECT NO.	193215A	DATE	08/15/2020
DRAWN BY	Adair	SCALE	1" = 40'

**AGENCY VEHICLE COUNT**

45' Buses	22
35' Buses	28
24' to 25' Buses	20

**TOTAL:** 70

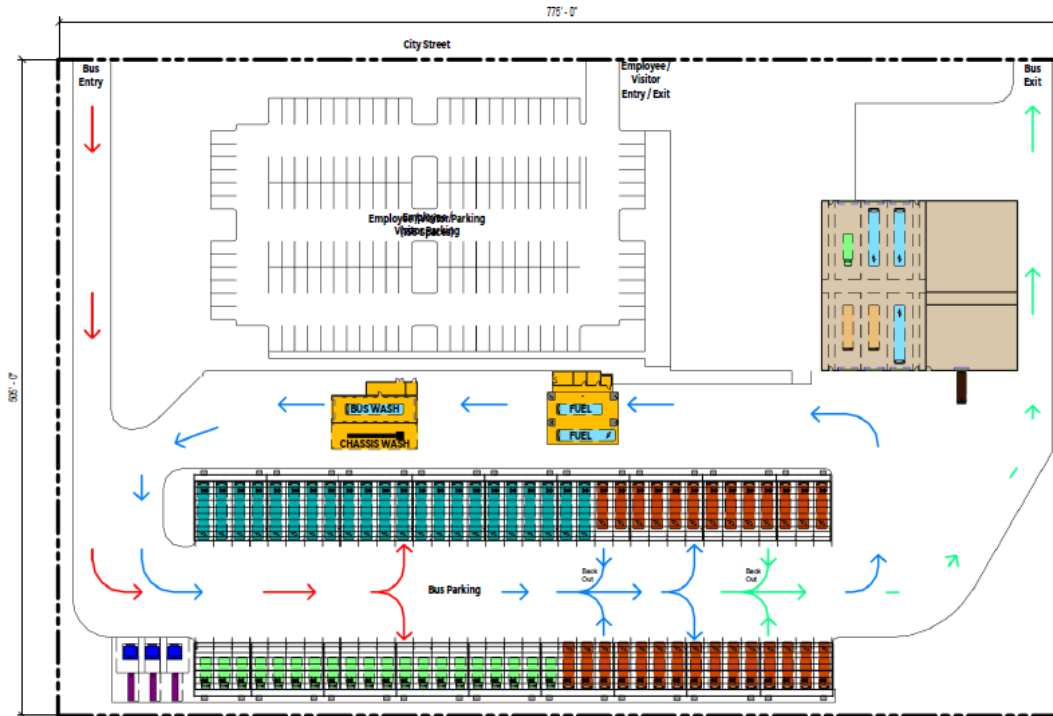

**CIRCULATION**



- Inbound →
- Internal →
- Outbound →

Page D.12

DRAWING NUMBER <b>OPT 4 SP8</b>	DRAWING TITLE <b>90 Degree Double Loaded Pull-In Parking Circulation</b>	 WSP WASHINGTON 10300 PARKWAY SUITE 200 TEXAS 77104 TEL: (281) 980-9900 FAX: (281) 790-1504	 Yuba-Sutter Transit	PROJECT TITLE Yuba-Sutter Transit Resilient Next Generation Transit Facility Plan	PROJECT NO. 193215A
				DATE 01/15/2020	SCALE 1" = 40'

BIM 360://HOU-193215A - YUBA SUTTER NEXT GEN BEB OMF 2019 - R19/Yuba-Sutter Greenfield.rvt 8/4/2020 1:52:45 PM

**AGENCY VEHICLE COUNT**

45' Buses		22
35' Buses		28
24' to 25' Buses		20
<b>TOTAL:</b>		<b>70</b>

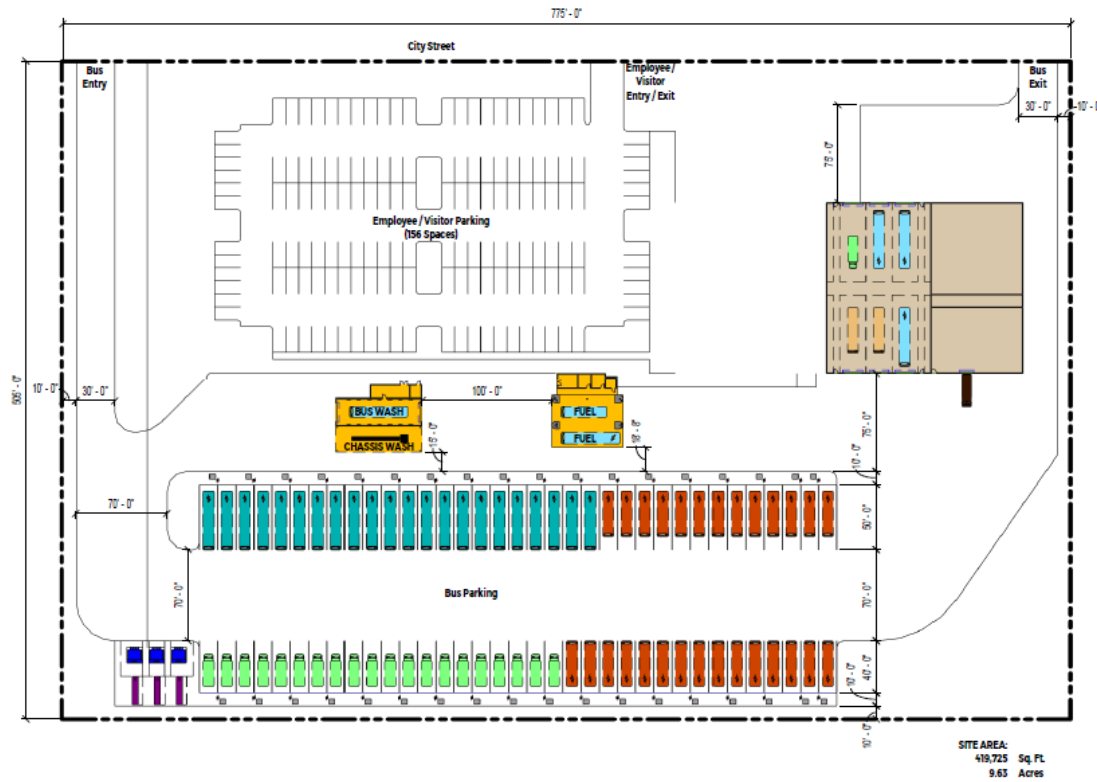



Page D.13

BIM 360//HOU-193215A - YUBA SUTTER NEXT GEN BEB OMF 2019 - R19/Yuba-Sutter Greenfield.rvt

DRAWING NUMBER	OPT 5	DRAWING TITLE	90 Degree Double Loaded Back-In Parking	 <small>WSP PARTNERS 1500 MARKCROW SUITE 200 TEXAS ST. #104 DALLAS, TX 75201 TEL: (214) 398-8000 FAX: (214) 398-1556</small>		PROJECT NO.	193215A
	SP9					PROJECT TITLE	Yuba-Sutter Transit Resilient Next Generation Transit Facility Plan
						DATE	06/15/2020
						SCALE	1" = 40'-0"



8/4/2020 1:52:46 PM

**AGENCY VEHICLE COUNT**

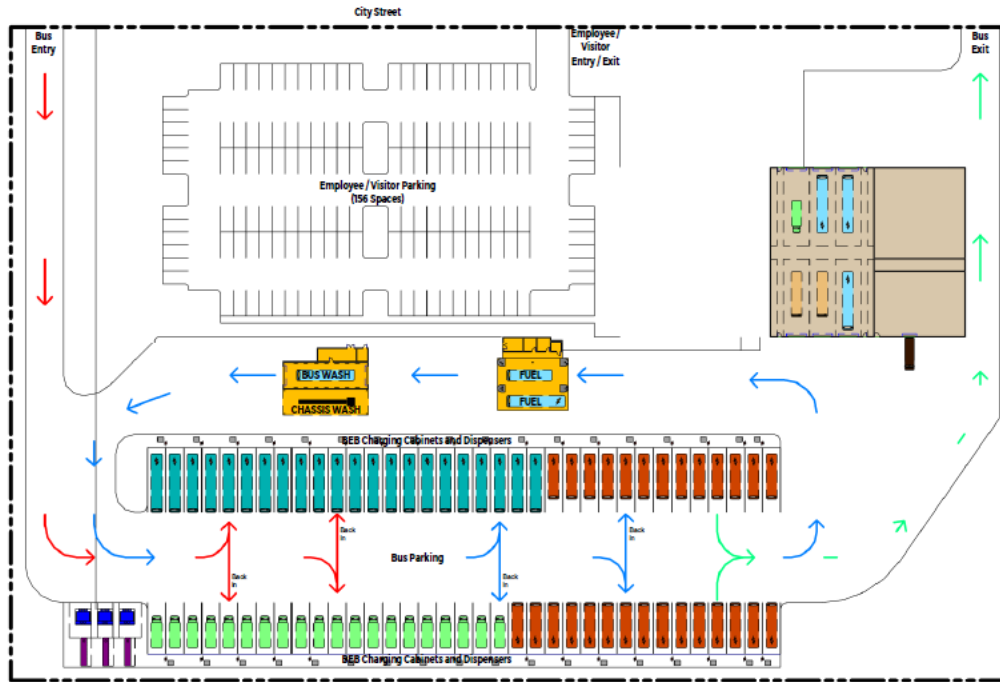
45' Buses		22
35' Buses		28
24' to 25' Buses		20
<b>TOTAL:</b>		<b>70</b>



**CIRCULATION**

- Inbound 
- Internal 
- Outbound 

Page D.14

BIM 360://HOU-193215A - YUBA SUTTER NEXT GEN BEB OMF 2019 - R19/Yuba-Sutter Greenfield.rvt

DRAWING NUMBER	OPT 5	DRAWING TITLE	90 Degree Double Loaded Back-in Parking Circulation
	SP10		
PROJECT NO.	B225A	PROJECT TITLE	Yuba-Sutter Transit Resilient Next Generation Transit Facility Plan
	08/15/2020		
DESIGN BY	Autor	DATE	08/15/2020
SCALE	1" = 48'0"		
			
		1800 JARVIS RD YUBA, CA 95994 TEL: (530) 924-7704 TEL: (530) 924-9900 FAX: (530) 756-5184	

8/4/2020 1:52:47 PM

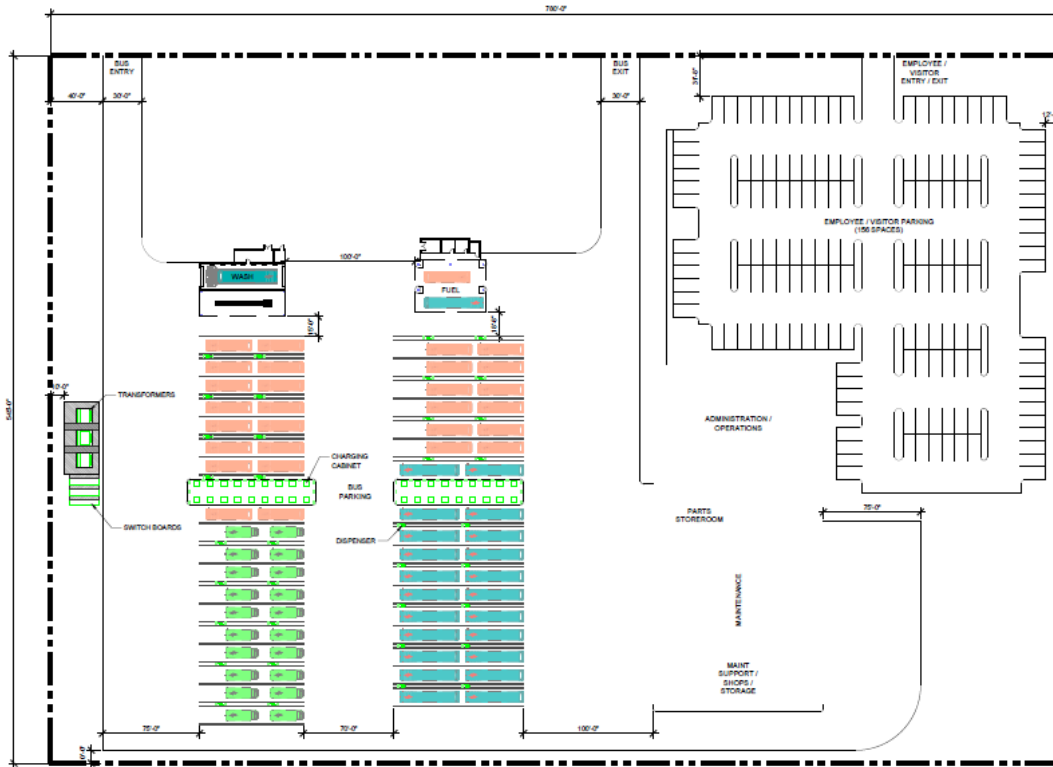

Page D.15

DRAWING NUMBER	SP.11
DRAWING TITLE	SITE PLAN TRACK PARKING
 WSP USA, INC. 16300 PARKWAY HOUSTON, TEXAS 77064 TEL: 281-416-8000 FAX: 281-416-1006	
 Yuba-Sutter Transit	
PROJECT TITLE	YUBA-SUTTER TRANSIT RESILIENT NEXT GENERATION TRANSIT FACILITY PLAN
PROJECT NO.	95228A
DRAWN BY	RR
DATE	07/15/2020
SCALE	200% 1" = 40'-0" 112.17 1" = 80'-0"



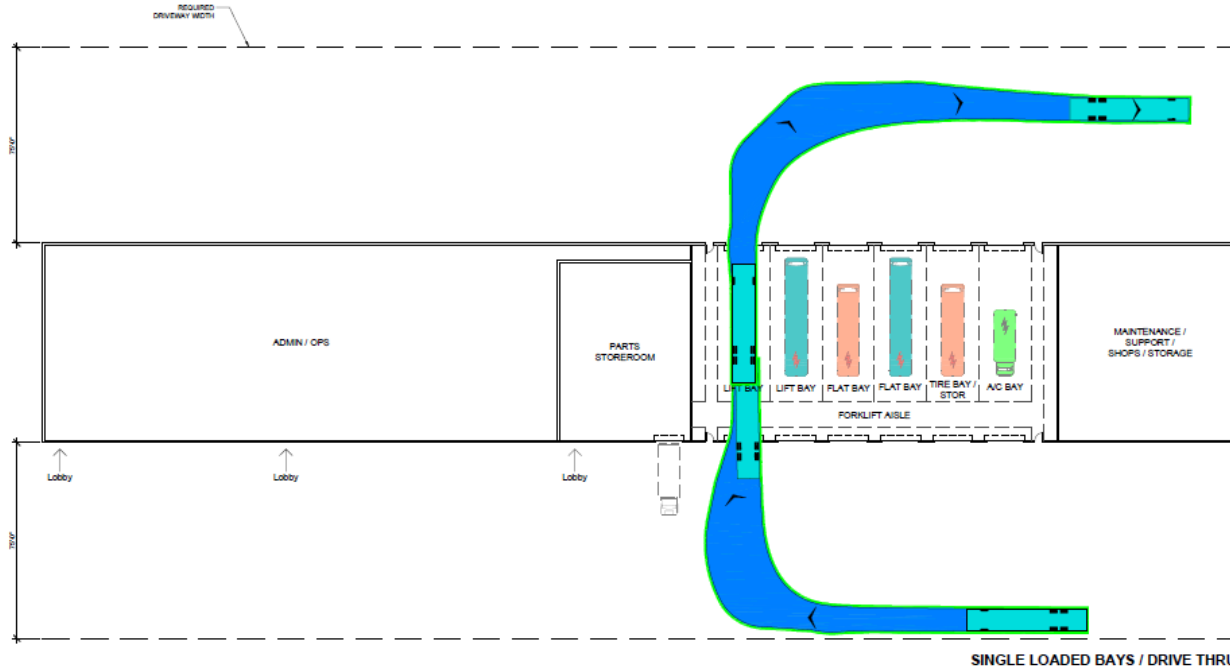

Page D.16

DRAWING NUMBER	A.1	PROJECT NO.	19225A
DRAWING TITLE	YUBA-SUTTER MAINTENANCE BLDG OPTION 1	DRAWN BY	RR
		DATE	07/15/2020
		SCALE	20x8 1" = 20'-0" 11x17 1" = 40'-0"
		PROJECT TITLE	YUBA-SUTTER TRANSIT RESILIENT NEXT GENERATION TRANSIT FACILITY PLAN
			<small>           NETA USA INC.            1600 PARKWAY            SUITE 100            HEALING SPRINGS, TEXAS 77044            TEL: (281) 488-8800            FAX: (281) 488-8808         </small>

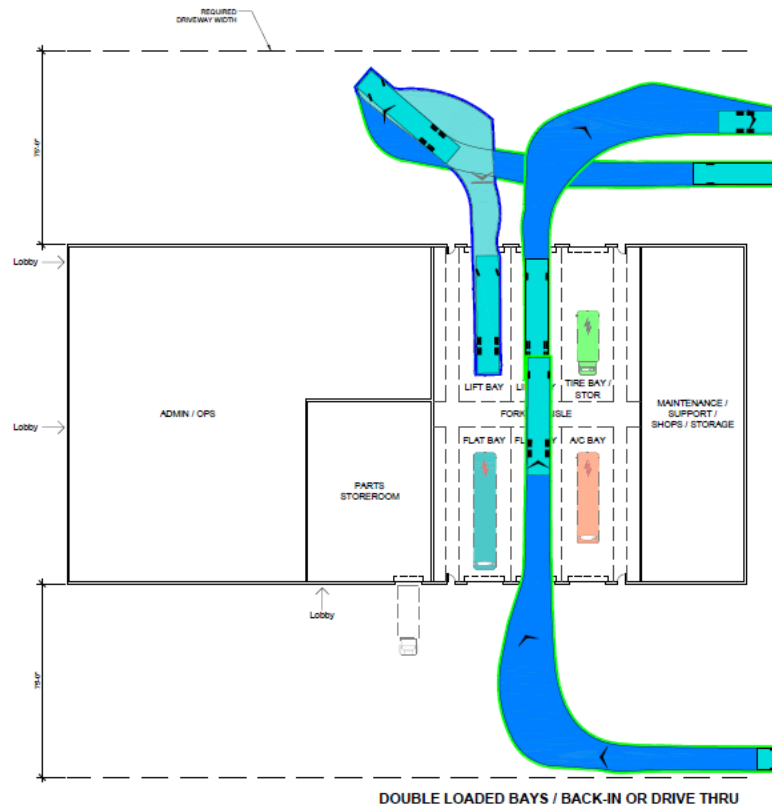
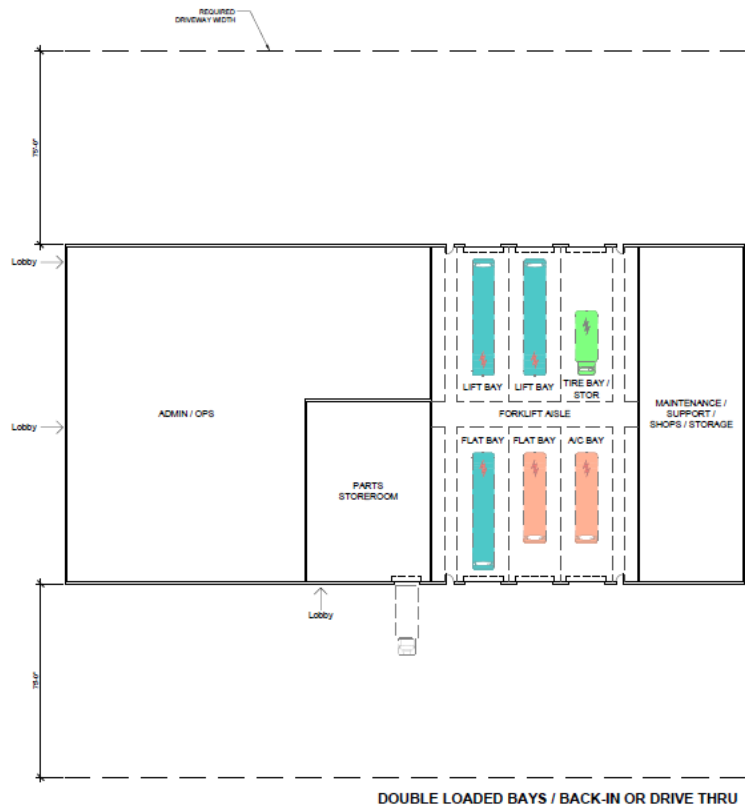

Page D.17

DRAWING NUMBER	A.2A	DRAWING TITLE	YUBA-SUTTER MAINTENANCE BLDG OPTION 2A	 WSP USA, INC. 1000 PARK/SUN HUNTER, TEXAS 77044 TEL: (281) 598-9900 FAX: (281) 598-9904	 YUBA-SUTTER TRANSIT RESILIENT NEXT GENERATION TRANSIT FACILITY PLAN	PROJECT NO.	16225A
	SCALE		1" = 20'-0"			DATE	01/15/2020

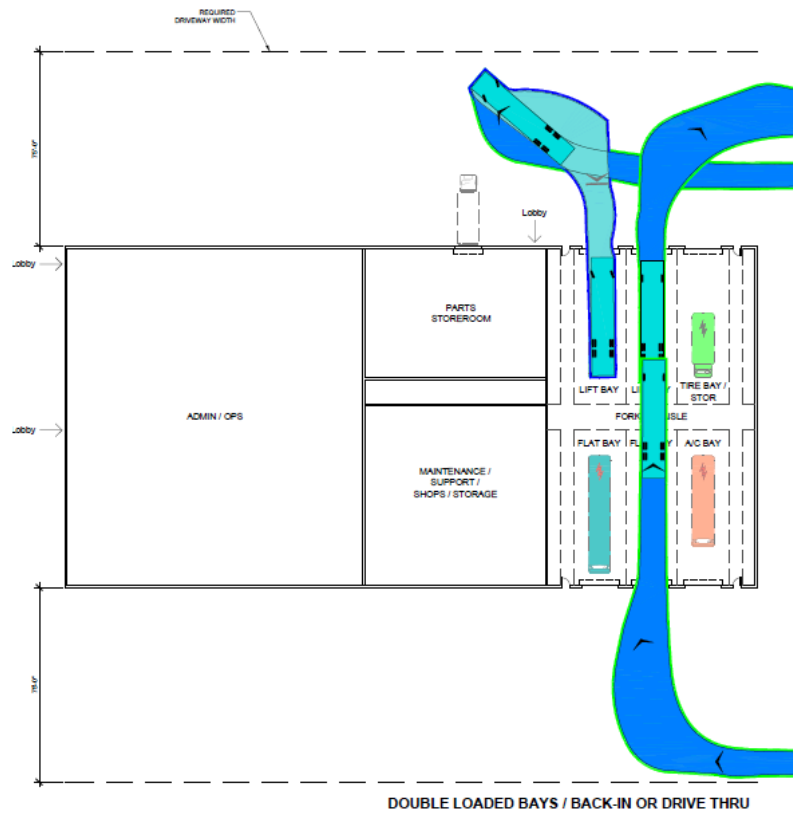
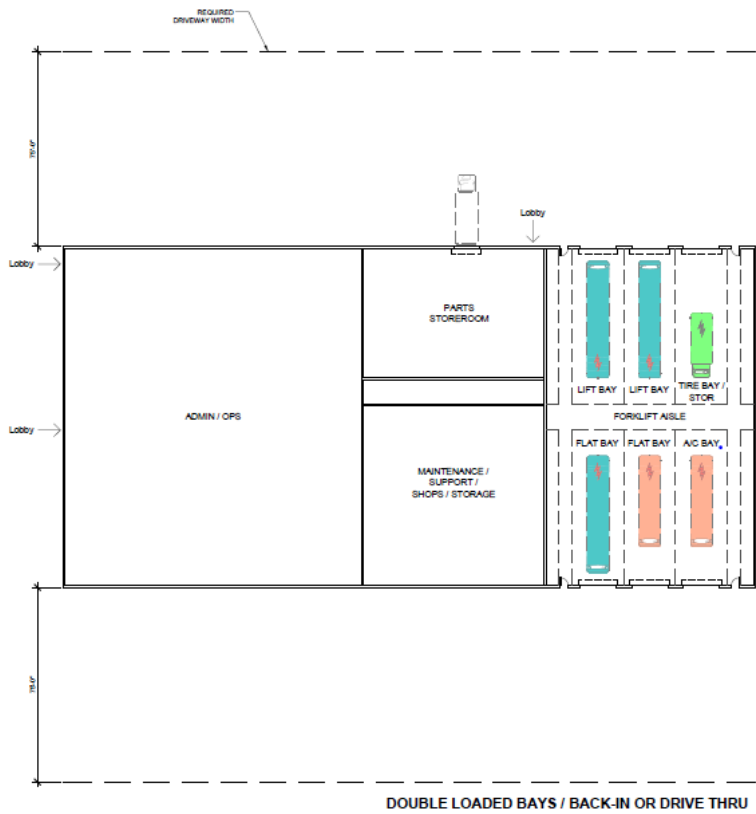

Page D.18

DRAWING NUMBER	PROJECT NO. 95025A			
	DRAWN BY BR			
DRAWING TITLE	YUBA-SUTTER TRANSIT RESILIENT NEXT GENERATION TRANSIT FACILITY PLAN			
	DATE 01/10/2020			
DRAWING NUMBER	SCALE 1" = 20'-0"			
	11.11.17 1" = 40'-0"			
				
WSP WSP CONSULTING INC. 1000 SUTTER BLVD. SUITE 200 YUBA, CA 95901 TEL: (916) 924-9000 FAX: (916) 924-9104				
YUBA-SUTTER MAINTENANCE BLDG OPTION 2B				
A.2B				

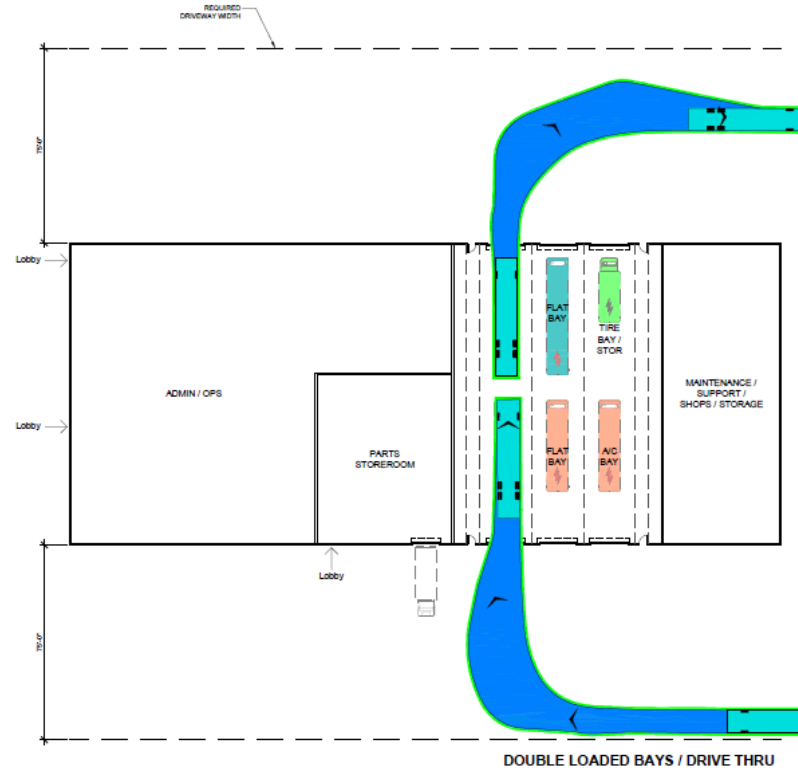
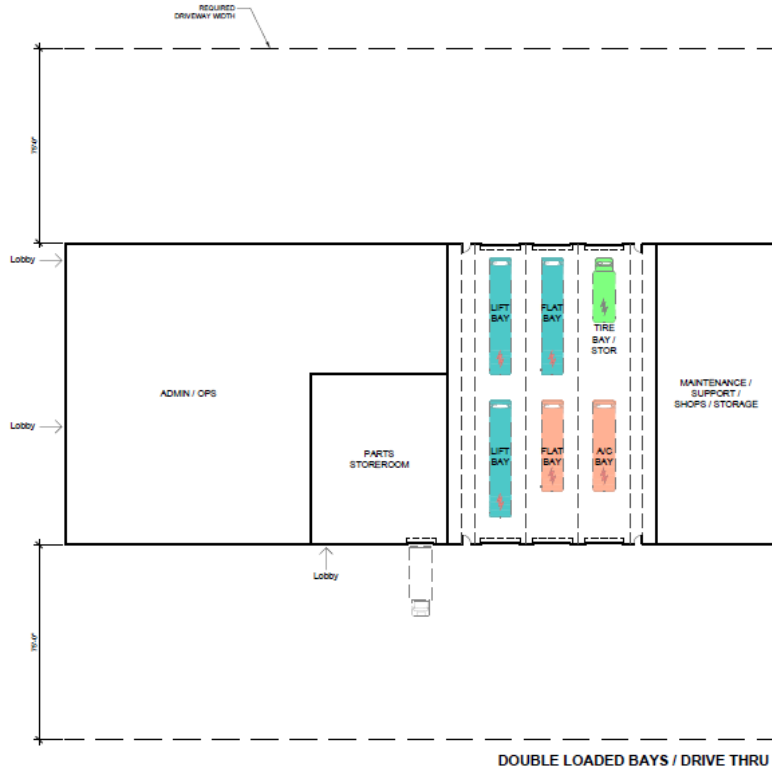

DRAWING NUMBER	PROJECT NO.		
	19225A	RR	
DRAWING TITLE	PROJECT TITLE		
	YUBA-SUTTER TRANSIT RESILIENT NEXT GENERATION TRANSIT FACILITY PLAN		
A. 3A			
	WSP INC. 1400 PARK ROW SUITE 200 YUBA, CALIFORNIA 95901 TEL: (916) 885-8000 FAX: (916) 798-1156		
DRAWING TITLE		PROJECT NO.	
YUBA-SUTTER MAINTENANCE BLDG OPTION 3A		19225A	
DRAWING NUMBER		DRAWN BY	
A. 3A		RR	
		DATE	
		07/15/2020	
		SCALE	
		250% 1" = 20'-0"	
		115.1% 1" = 40'-0"	

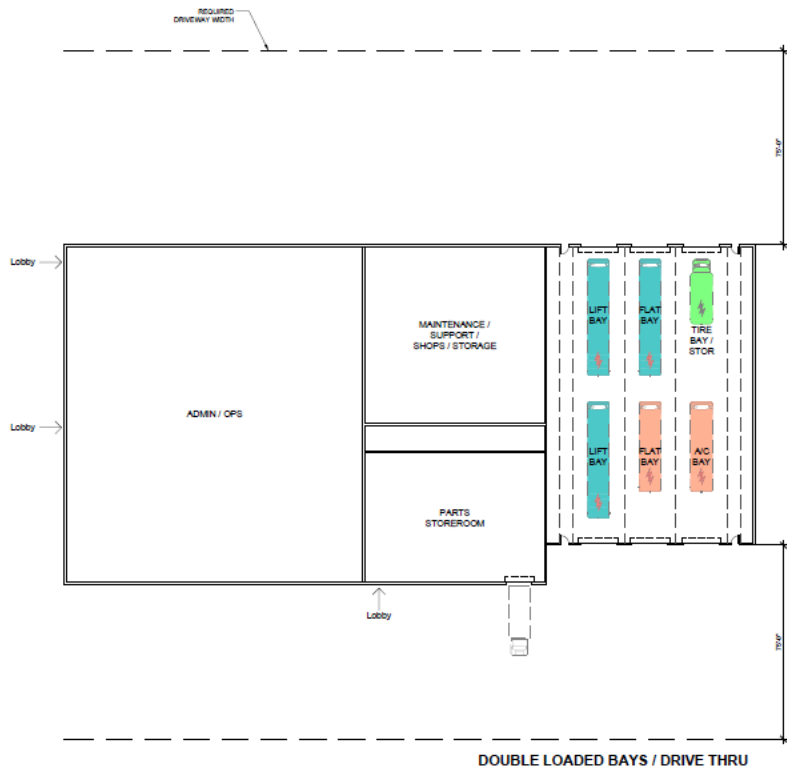

DRAWING NUMBER	DRAWING TITLE		
	YUBA-SUTTER MAINTENANCE BLDG OPTION 3B		
DRAWING NUMBER	PROJECT NO.	PROJECT TITLE	
		YUBA-SUTTER TRANSIT RESILIENT NEXT GENERATION TRANSIT FACILITY PLAN	
DRAWING NUMBER	PROJECT NO.	DRAWN BY	DATE
DRAWING NUMBER	PROJECT NO.	SCALE	
		1" = 20'-0" 1" = 40'-0"	
DRAWING NUMBER		PROJECT NO.	
DRAWING NUMBER		PROJECT NO.	

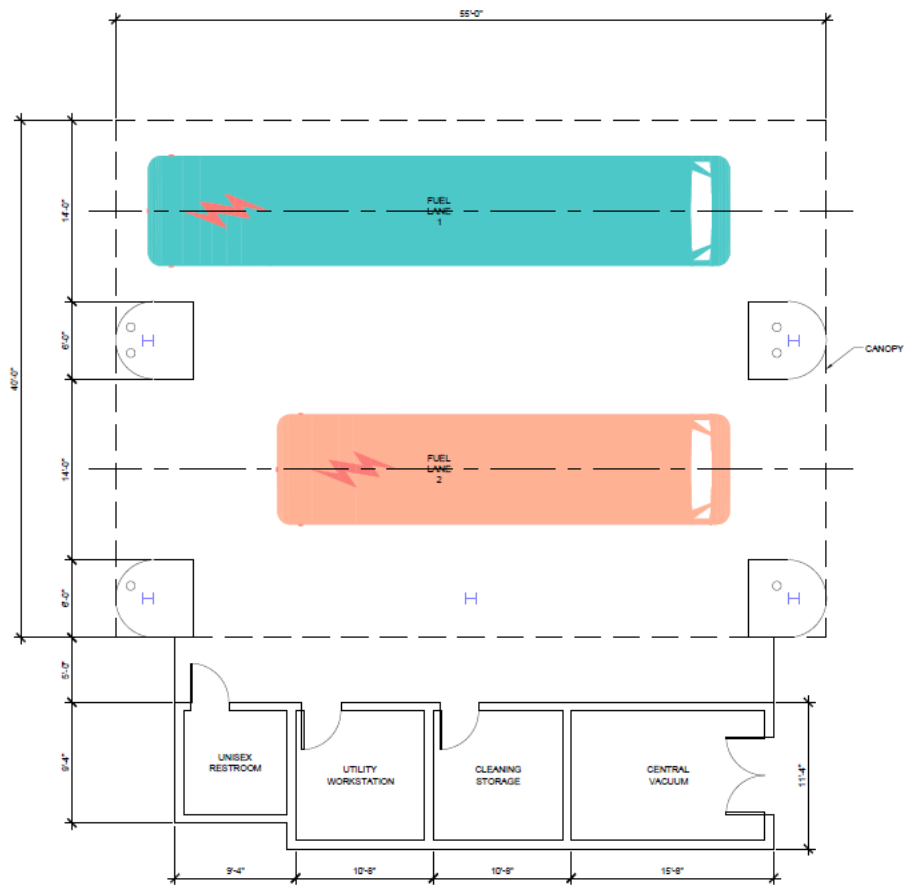

Page D.21

DRAWING NUMBER	DRAWING TITLE	 WSP INC. 1400 PARKWAY SUITE 200 YUBA, CALIFORNIA 95904 TEL: 530.926.0000 FAX: 530.926.1004	 Yuba-Sutter Transit	PROJECT TITLE	PROJECT NO.	93215A
					DOWN BY	RR
A. 4	FUEL LANES			YUBA-SUTTER TRANSIT RESILIENT NEXT GENERATION TRANSIT FACILITY PLAN	DATE	01/10/2020
					SCALE	2004 1/4" = 1'-0" 11/11/17 1/8" = 1'-0"

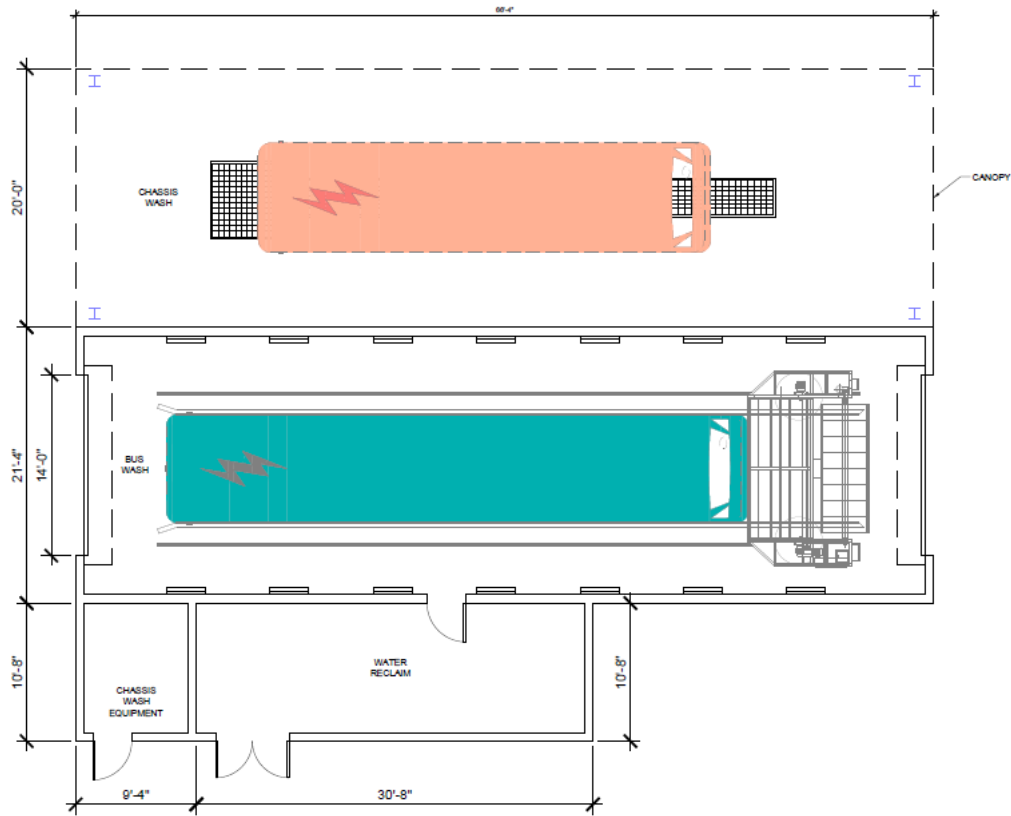

Page D.22

DRAWING NUMBER	A.5	DRAWING TITLE	DRIVE-TRHU WASH / CHASSIS WASH		WSP USA, INC. 8075 LAKEMAN DRIVE, SUITE 300 DUBLIN, CA 94568 TEL: (925) 835-6000 FAX: (925) 785-1554		PROJECT TITLE	YUBA-SUTTER TRANSIT RESILIENT NEXT GENERATION TRANSIT FACILITY PLAN	PROJECT NO.	93215A
	SCALE		1" = 11'-0" 1/8" = 11'-0"					DATE		06/10/2020

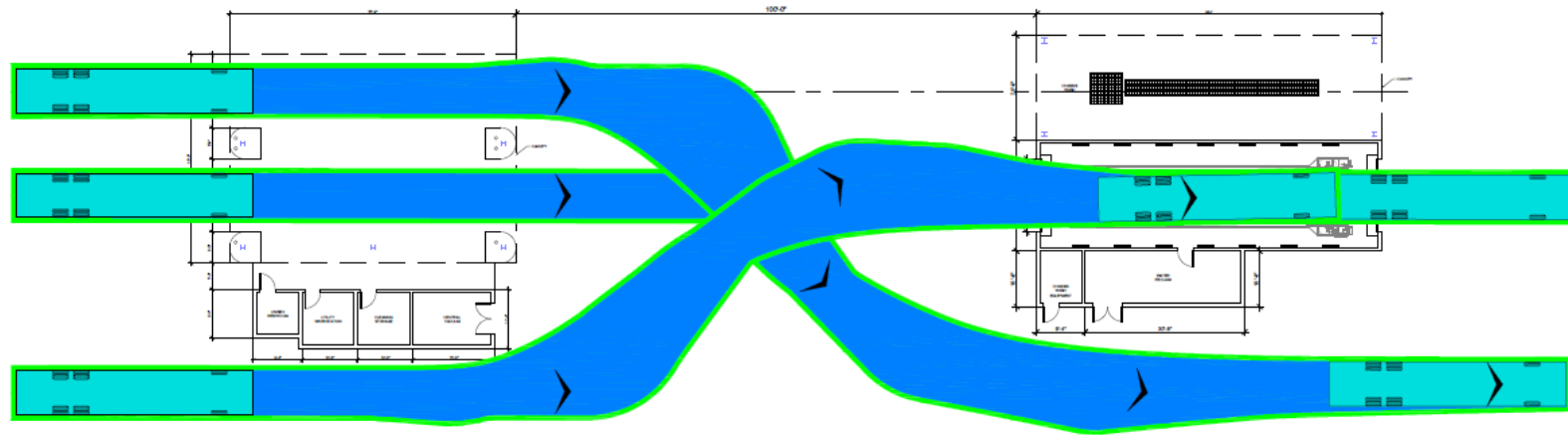

DRAWING NUMBER	PROJECT TITLE	PROJECT TITLE	PROJECT NO.	PROJECT NO.
A.6	FUEL AND WASH CIRCULATION PLAN	YUBA-SUTTER TRANSIT RESILIENT NEXT GENERATION TRANSIT FACILITY PLAN	9322/SA	9322/SA
			DRAWN BY	DR
			DATE	01/15/2020
			SCALE	AS SHOWN 1" = 10'-0" 1/4" = 20'-0"
				
		WSP INC. 1400 PARK ROW SUITE 200 TEJAS, TEXAS 77854 TEL: (817) 438-0300 FAX: (817) 758-0156		
				